

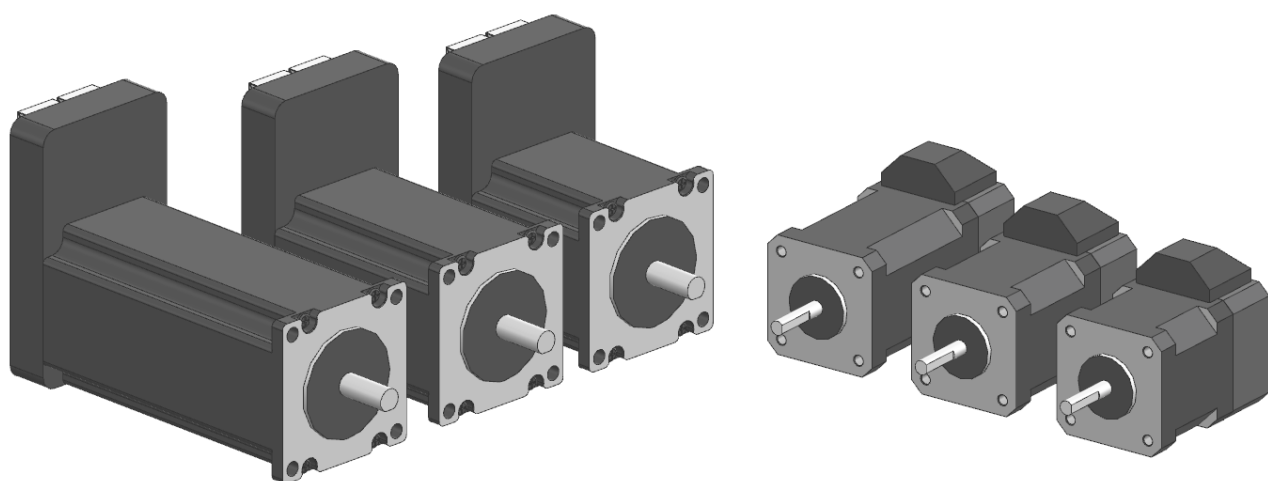

BAICHUAN

百川智源



一体式步进伺服

MD 系列用户手册

版本 V1.9

深圳市百川智源科技有限公司

目录

1	阅读前须知	- 4 -
1.1	声明	- 4 -
1.2	文档历史	- 4 -
2	安全	- 5 -
2.1	安全须知	- 5 -
2.2	安全操作指南	- 6 -
2.3	软件更新与维护	- 6 -
3	产品概述	- 7 -
3.1	命名规则	- 7 -
3.2	MD-42 系列	- 8 -
3.3	MD-57 系列	- 15 -
3.4	开箱及存储	- 22 -
3.5	保修期与保修范围	- 23 -
4	接线	- 24 -
4.1	MD-42 系列	- 24 -
4.2	MD-57 系列	- 29 -
5	调试	- 31 -
5.1	注意事项	- 31 -
5.2	调试软件	- 31 -
5.3	使用软件调试	- 49 -
6	功能	- 67 -
6.1	转矩限制	- 67 -
6.2	斜坡函数发生器	- 68 -
6.3	设置机械系统	- 69 -
6.4	速度滤波器	- 70 -
6.5	电机旋转方向	- 71 -
6.6	闭环控制器	- 72 -
6.7	弱磁控制	- 75 -
6.8	电流控制器	- 76 -
6.9	位置速度到达检测	- 82 -
6.10	保护功能	- 85 -

6.11	零点搜索功能	- 91 -
6.12	点动功能	- 93 -
6.13	程序块功能	- 94 -
7	通信	- 96 -
7.1	控制端与被控端	- 96 -
7.2	PROFINET 通信	- 97 -
7.3	MODBUS TCP 通信	- 110 -
8	样例	- 115 -
8.1	西门子 S7-1200 样例(PROFINET)	- 115 -
8.2	西门子 S7-1200 样例(MODBUS-TCP)	- 159 -
8.3	西门子 S7-200 SMART 样例(PROFINET)	- 182 -
9	诊断	- 219 -
9.1	说明	- 219 -
9.2	警告列表	- 220 -
9.3	报警列表	- 221 -
9.4	故障列表	- 221 -
10	参数表	- 222 -
10.1	基本参数	- 222 -
10.2	闭环控制参数	- 224 -
10.3	弱磁控制参数	- 225 -
10.4	电流控制参数	- 226 -
10.5	信号参数	- 228 -
10.6	保护功能参数	- 229 -
10.7	回零参数组	- 232 -
10.8	点动参数组	- 234 -
10.9	程序块参数组	- 234 -
10.10	程序块组	- 235 -
11	常见问题	- 241 -

1 阅读前须知

1.1 声明

1.1.1 免责声明

我们在此声明，我们的产品仅在技术层面兼容 PROFINET® 协议标准。但请注意，该产品尚未取得 PROFINET International (PI) 的官方认证或支持。

1.1.2 商标

Windows 是 Microsoft Corporation (微软公司) 的注册商标。

PROFINET® 是 PROFINET International (PI) 的注册商标。

1.1.3 法律声明

本产品未经任何官方机构的安全认证，用户应自行评估并确保使用环境的安全性。对于未按说明书要求使用本产品导致的任何损害，本公司概不负责。本公司不对由于不可抗力（如自然灾害、战争等）导致的任何损失承担责任。

1.1.4 文档声明

手册不随产品发货，请从深圳百川智源科技有限公司官方网站(www.szbczy.cn)获取最新的电子版文档。

尽管我们已尽力确保本文档所述内容与硬件和软件的一致性，但仍可能存在偏差。因此，我们无法保证本文档所述内容与实际硬件和软件完全一致。如有发现偏差，我们将在后续的新版本文档中进行更新。请保持关注最新版本的文档以获取最准确的信息。

1.2 文档历史

版本号	发行日期	说明
V1.0	2024.08.01	首发
V1.1	2024.12.11	图文描述更新
V1.2	2024.12.26	通信、样例章节增加内容
V1.3	2025.02.18	调试章节增加内容
V1.4	2025.05.13	产品参数图表更新、样例章节增加 s7-200 smart
V1.5	2025.08.06	文档 增加 MD-57 系列产品
V1.6	2025.09.04	参数表更新、厂家报文输入(驱动器->PLC)状态字定义新增
V1.7	2025.11.17	新增 报文 111 (固件 1.0.6 版本以上支持)，更新了样例章节部分图文
V1.8	2025.12.03	部分描述修改，57 接线图文更换
V1.9	2026.05.08	图文描述更新； 章节【通信】厂家报文、报文 111 输入输出定义更新功能； 章节【样例】去除 MD_PN\MD_MBTCP.scl 块； 章节【常见问题】内容新增

2 安全

2.1 安全须知

1. 适用范围与安全声明

- 本产品仅适用于非安全关键型应用。
- 本产品尚未获得任何官方机构的安全认证，用户应自行评估并确保使用环境的安全性。

2. 用户责任

- 用户应根据产品手册和安全操作指南使用本产品，并确保产品的安装、使用和维护符合当地的安全标准和法规要求。
- 确保所有操作符合法规要求，包括但不限于电气安全、职业健康与安全等方面的规定。
- 确保在产品的规格范围内使用本产品，如在规格范围外使用，可能导致产品故障、失效、使用寿命缩短等。
- 设计安全回路或装置，在本产品发生故障时，能有效避免设备损坏、人身事故等。
- 在使用过程中出现包括但不限于冒烟、产生火光、起火等异常现象，应立即断开电源。

3. 使用环境

- 不建议在过高温或过低温环境中使用本产品，以免影响其性能和寿命。
- 禁止在易燃、易爆或有其他危险因素的环境中使用本产品。
- 禁止在潮湿、有水汽、腐蚀性气体或可燃性气体的环境中安装本产品。
- 禁止在强电磁场或高频干扰的环境中使用本产品，以防止设备故障或数据丢失。
- 禁止在尘埃较多或有大量颗粒物的环境中使用本产品，以免尘埃进入设备内部造成损坏。

2.2 安全操作指南

1. 安装与维护

- **专业操作：** 确保产品的安装、使用和维护由具备相应电气操作知识和经验的专业人士进行。
- **通风条件：** 本产品在工作时会产生热量，安装时确保有良好的通风条件，并且避免直接接触本体。
- **防护措施：** 电机及其连接的机械设备可能造成夹伤、卷入等危险，应设置防护罩或者其他物理屏障来保护操作者免受伤害。
- **警告标识：** 在电机通电、断电、维护时，应通知电机及其连接的机械设备工作范围内的所有人员撤离，并设立警示牌。
- **电气连接检查：** 确保所有电气连接都正确无误，防止短路或触电事故。
- **紧固件检查：** 应选用合适的紧固件对该产品进行安装，并确保紧固件紧固力度适中，避免因过紧造成滑丝等损坏。
定期检查设备及其连接的所有紧固件，确保没有松动现象，以防止意外事故的发生。
- **线缆检查：** 避免线缆接触到尖锐物体或重物压迫，防止物理损伤。
不要将线缆过度弯曲或扭曲，以免线缆受损。
不要将线缆放置在高温环境中，以免加速线材老化。
定期检查线缆外皮是否完好，确保没有因为老化导致的破损。

2. 操作安全

- **阅读手册：** 在安装、操作和维护本产品之前，请务必仔细阅读并理解产品手册。
- **软件来源：** 请从官方途径获取软件，非官方途径获取的软件可能存在被篡改等问题，从而引发系统性的安全问题，严重时可导致人员伤亡或财产损失。
- **急停功能：** 电机具有急停功能。硬件老化(开关触点、线缆)及不正确的参数设置、接线(虚接、错接)等都有可能使安全功能失效。
定期检查急停功能是否生效。
- **禁止私自改动：** 严禁改动、拆解组装本产品，包括但不限于(拧动原有的紧固螺栓、将线缆切断后重新连接来延长或缩短产品线缆的长度)。私自修改、拆解、维修本产品可能会导致设备故障和引发功能异常，严重时可导致人员伤亡或财产损失。若发现设备已被修改、拆解、维修等，请停止使用。
- **防范恶意软件：** 病毒、木马或其它的恶意软件等，可能会使软件被篡改从而引发系统性的安全问题，从而导致人员的伤亡或财产损失。应采取相应的保护措施(定期使用杀毒软件)。
- **个人防护装备：** 操作人员在进行维护或操作时应穿戴适当的个人防护装备(PPE)，如绝缘手套、护目镜等。
- **培训与资格：** 确保所有操作人员都接受了充分的安全培训，并具备相应的操作资质。

2.3 软件更新与维护

1. 软件更新

- **定期更新：** 本产品发布后也会不定期进行软件更新，以解决新发现的问题。定期的更新有助于提高设备整体安全性。
- **更新频率：** 建议用户定期检查是否有新的软件版本可供下载。

2. 软件维护

- **BUG 提交：** 如果用户在使用过程中发现任何问题或 BUG，可以向经销商提交反馈，以便我们及时进行处理和改进。

3 产品概述

3.1 命名规则

MD-42 40-XX

① ② ③ ④

	标识		说明
①产品系列	MD		一体式步进伺服系列
②机座尺寸	42		42mm x 42mm
	57		57mm x 57mm
③电机长度	42 机座	40	40mm
		50	50mm
		60	60mm
	57 机座	56	56mm
		76	76mm
		112	112mm
④通讯方式	MBTCP		MODBUS TCP
	PN		PROFINET

3.2 MD-42 系列

3.2.1 产品参数

MD 42 电机产品参数			
基本参数			
产品型号	MD-4240-XX	MD-4250-XX	MD-4260-XX
工作电压	DC 24V (±15%)		
最大耐压	30V		
待机电流	0.1A		
相电流	1.5A	1.8A	1.8A
电源防护	反接保护, 浪涌防护		
保持力矩	0.4 N.m	0.5 N.m	0.7 N.m
通信参数			
网络接口	1 * RJ45		
接口速率	10/100Mbps 自动协商		
通讯方式	Profinet / ModbusTCP		
性能参数			
编码器类型	单圈绝对值		
编码器分辨率	32768(15 位)		
位置控制分辨率	51200		
控制周期	20000Hz		
运动模式	相对位置模式/绝对位置模式/速度模式 主动回零模式/零点设置模式/程序块模式 点动模式/寸动模式		
运动平滑	梯形加减速控制		
保护功能	急停保护/跟随误差监视/堵转保护 硬限位保护/软限位保护 短路保护/过热保护		
Profinet IO 周期更新时间	1ms/2ms/4ms/8ms 16ms/32ms/64ms 128ms/256ms/512ms		
Profinet 支持从站数	S7-200smart 支持 8 个 S7-1200 支持 16 个 S7-1500 CPU1511 V4.0 固件 在不挂载其他 PROFINET 设备的情况下, 最多支持 128 台 S7-1500 CPU1513 V4.0 固件 在不挂载其他 PROFINET 设备的情况下, 最多支持 128 台 S7-1500 CPU1515 V4.0 固件 在不挂载其他 PROFINET 设备的情况下, 最多支持 256 台		
Profinet 平均响应时间	515us		
Profinet 最大响应时间	530us		
ModbusTCP 平均响应时间	2ms		
ModbusTCP 最大响应时间	16ms		

机械参数			
产品型号	MD-4240-XX	MD-4250-XX	MD-4260-XX
机座尺寸	42mm * 42mm		
电机长度	40mm	48mm	59mm
机身长度	60mm	68mm	79mm
轴直径	5mm		
轴负载	径向 25N, 轴向 30N		
重量	约 400g	约 470g	约 580g
转动惯量	55 g.cm ²	68 g.cm ²	73 g.cm ²
其他参数			
工作环境	0°C - 40°C (无冻结 无冷凝)		
防护等级	IP20		
连接方式	侧边出线, 线长约 0.5 米		

3.2.2 转矩特性

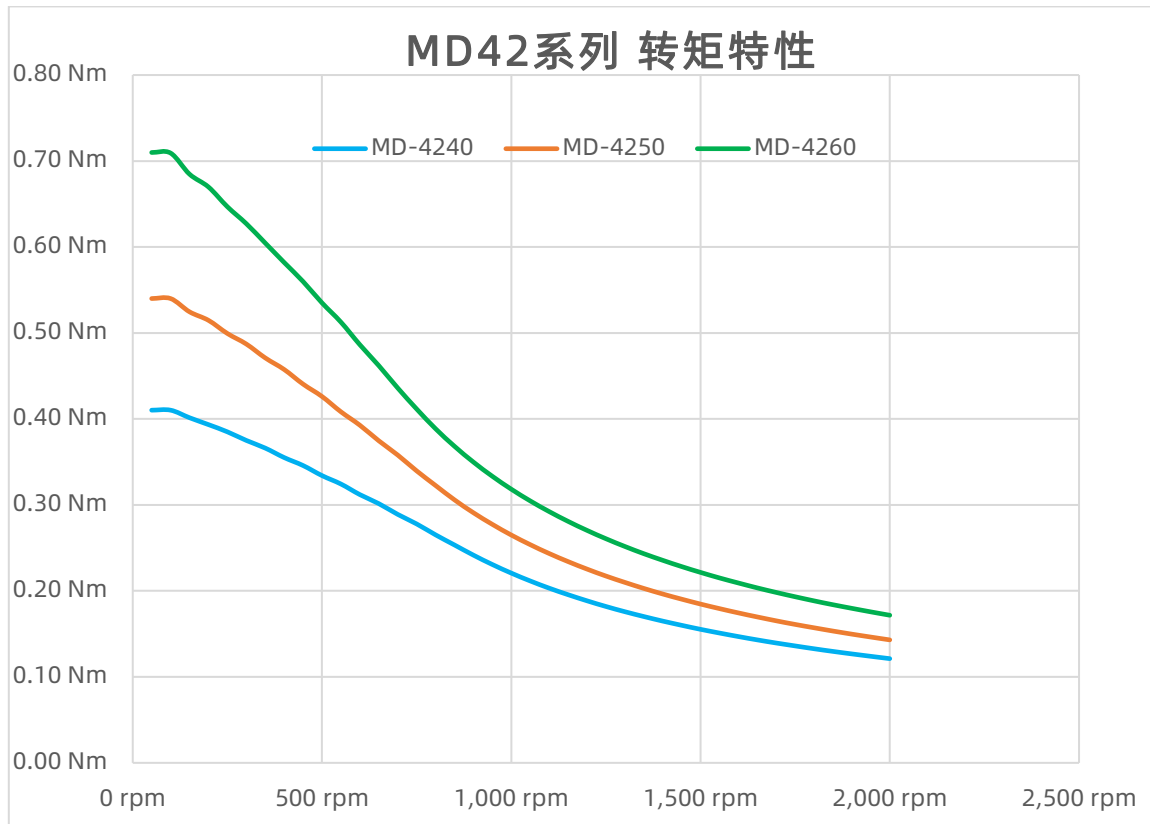

3.2.3 尺寸及外形

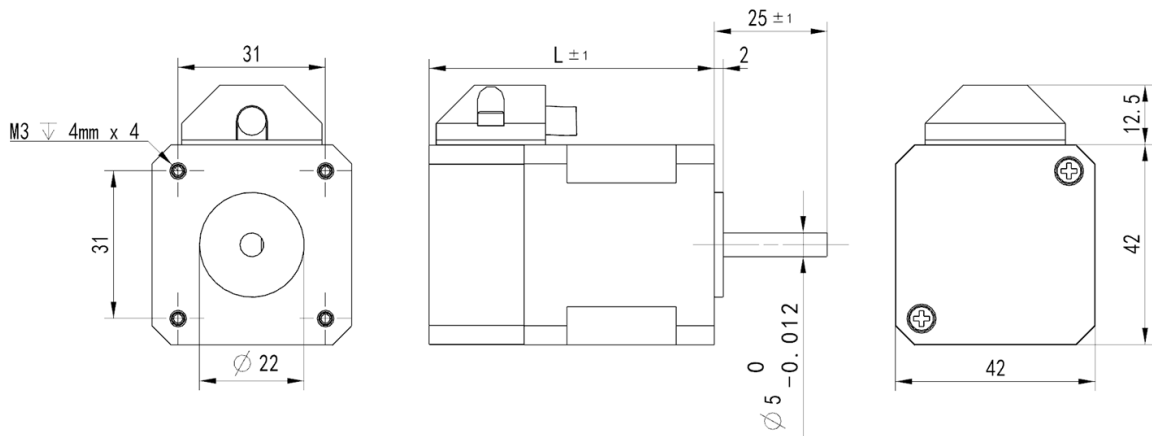

规格	尺寸L (mm)
MD-4240-XX	60
MD-4250-XX	68
MD-4260-XX	79

产品尺寸图

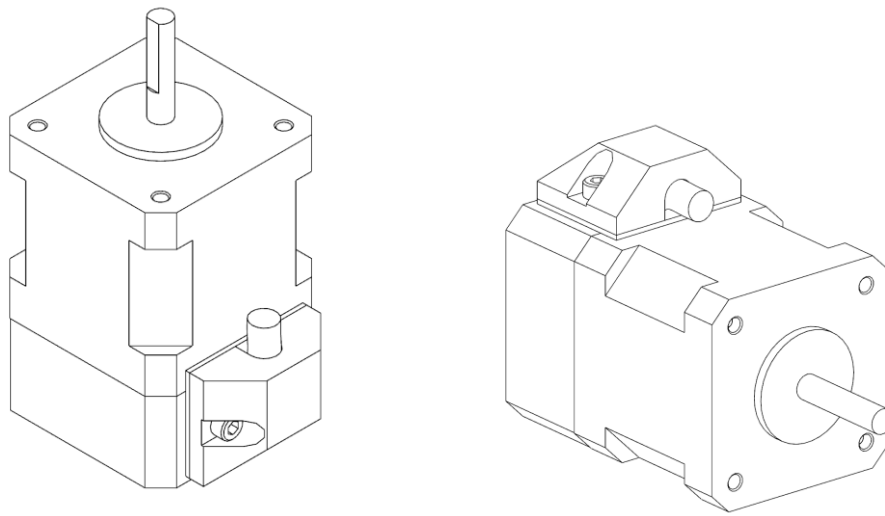

产品外形图

3.2.4 旋转方向定义

旋转方向可通过配置软件选择取反，在出厂默认不取反的情况下，正反方向的定义如下：

1、**正方向**：面对电机的出轴端，电机轴顺时针方向为正方向；

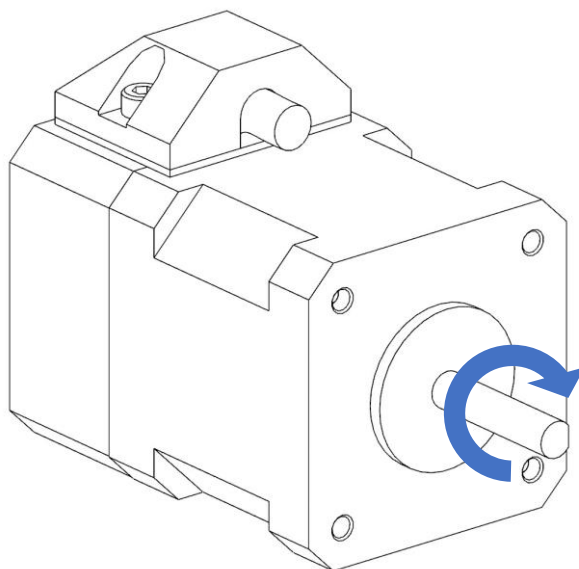

正方向示意图

2、**负方向**：面对电机的出轴端，电机轴逆时针方向为负方向；

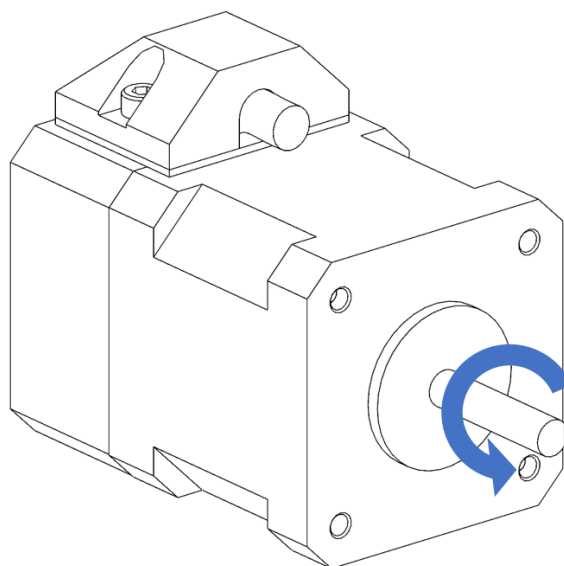



负方向示意图

3.2.5 LED 指示

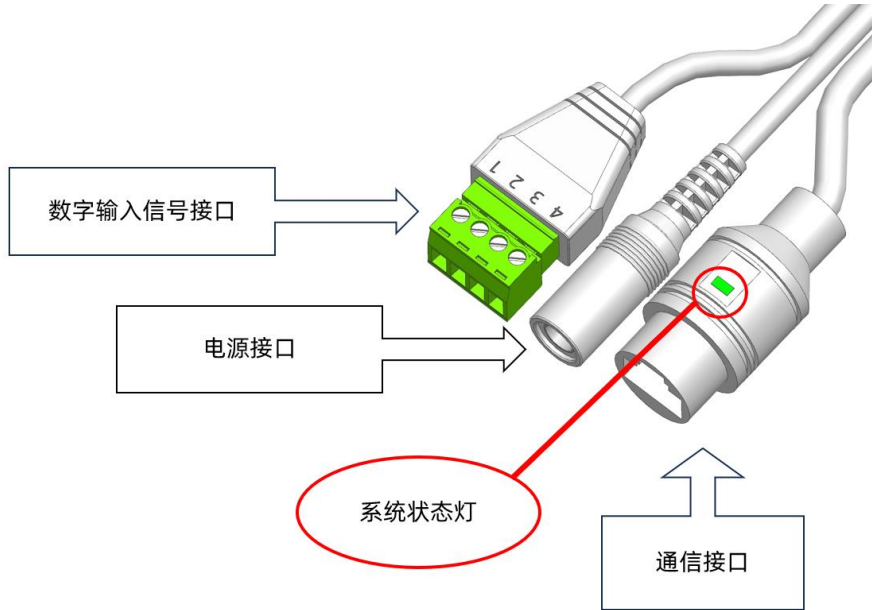
LED 灯信息: 通信接口上附带一个系统状态指示灯 (绿色 LED 灯), 方便诊断

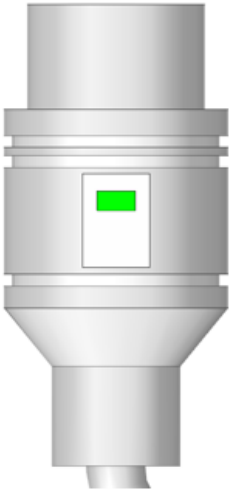

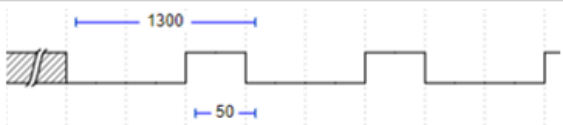
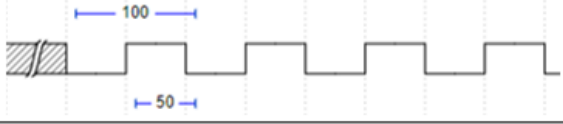
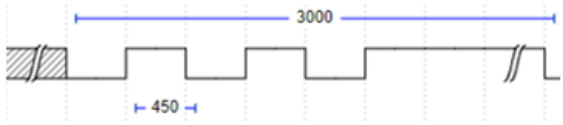
LED灯	说明	图示(单位:ms)
	1、常亮。 控制器已连接通信正常	
	2、间隔短闪。 无控制器连接	
	3、快闪。 设备初始化	
	4、周期闪烁三次后恢复 1/2/3状态。 查找设备功能	

3.2.6 包装清单

名称	数量	图示
电机本体	1 件	
网口防水 4 件套	1 套	
3.81 拔插端子 (默认安装在线上)	1 件	
电源线 (3 米)	1 件	

3.3 MD-57 系列

3.3.1 产品参数

MD 系列 57 电机产品参数			
基本参数			
产品型号	MD-5756-XX	MD-5776-XX	MD-57112-XX
工作电压	DC 24V (±15%)		
最大耐压	30V		
待机电流	0.1A		
相电流	4.0A	4.0A	4.2A
电源防护	反接保护, 浪涌防护		
保持力矩	1.3 N.m	2.0 N.m	3.2 N.m
通信参数			
网络接口	2 * RJ45		
接口速率	10/100Mbps 自动协商		
通讯方式	Profinet / ModbusTCP		
性能参数			
编码器类型	单圈绝对值		
编码器分辨率	32768(15 位)		
位置控制分辨率	51200		
控制周期	20000Hz		
运动模式	相对位置模式/绝对位置模式/速度模式 主动回零模式/零点设置模式/程序块模式 点动模式/寸动模式		
运动平滑	梯形加减速控制		
保护功能	急停保护/跟随误差监视/堵转保护 硬限位保护/软限位保护 短路保护/过热保护		
Profinet IO 周期更新时间	1ms/2ms/4ms/8ms 16ms/32ms/64ms 128ms/256ms/512ms		
Profinet 支持从站数	S7-200smart 支持 8 个 S7-1200 支持 16 个 S7-1500 CPU1511 V4.0 固件 在不挂载其他 PROFINET 设备的情况下, 最多支持 128 台 S7-1500 CPU1513 V4.0 固件 在不挂载其他 PROFINET 设备的情况下, 最多支持 128 台 S7-1500 CPU1515 V4.0 固件 在不挂载其他 PROFINET 设备的情况下, 最多支持 256 台		
Profinet 平均响应时间	515us		
Profinet 最大响应时间	530us		
ModbusTCP 平均响应时间	2ms		
ModbusTCP 最大响应时间	16ms		

机械参数			
产品型号	MD-5756-XX	MD-5776-XX	MD-57112-XX
机座尺寸	57mm * 57mm		
电机长度	56mm	76mm	112mm
机身长度	71.5mm	91.5mm	127.5mm
轴直径	8mm		
轴负载	径向 60N, 轴向 40N		
重量	约 823g	约 1.19kg	约 1.77kg
转动惯量	200 g.cm ²	350 g.cm ²	730 g.cm ²
其他参数			
工作环境	0°C - 40°C (无冻结 无冷凝)		
防护等级	IP20		
连接方式	侧边出线, 线长约 0.5 米		

3.3.2 转矩特性

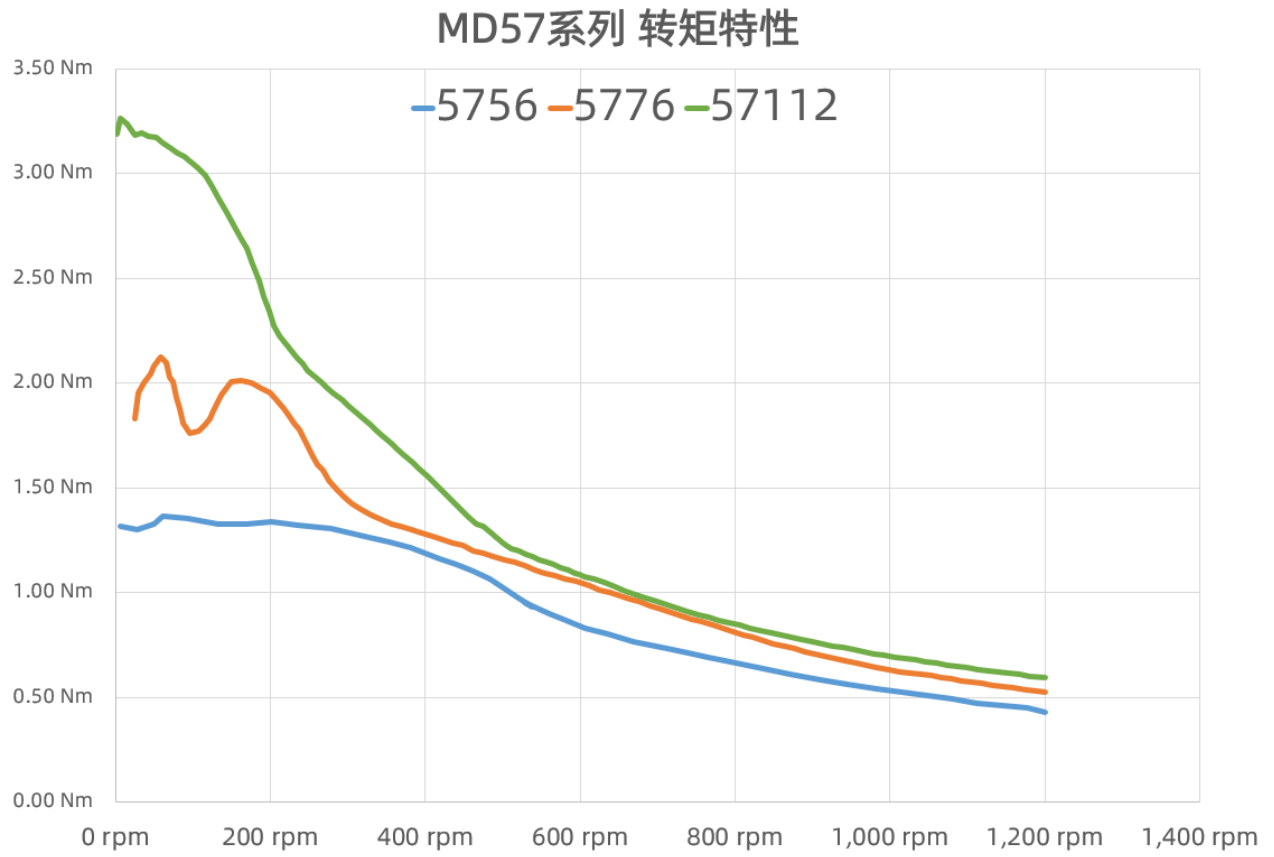

3.3.3 尺寸及外形

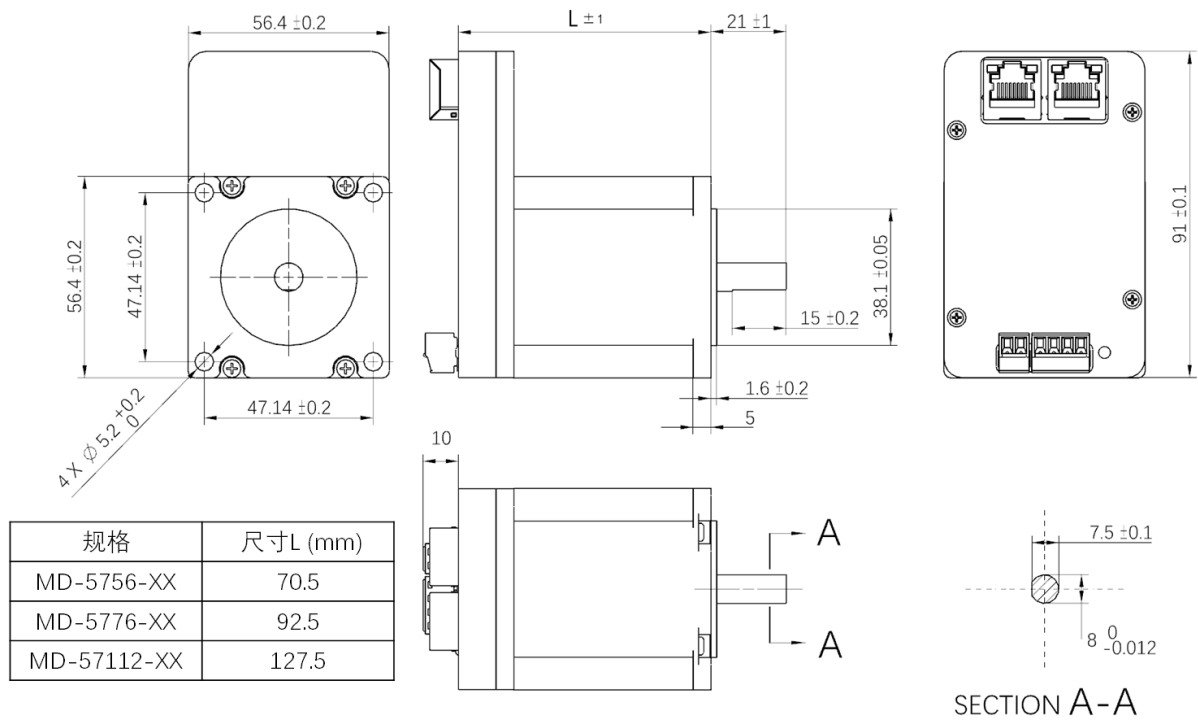

产品尺寸图

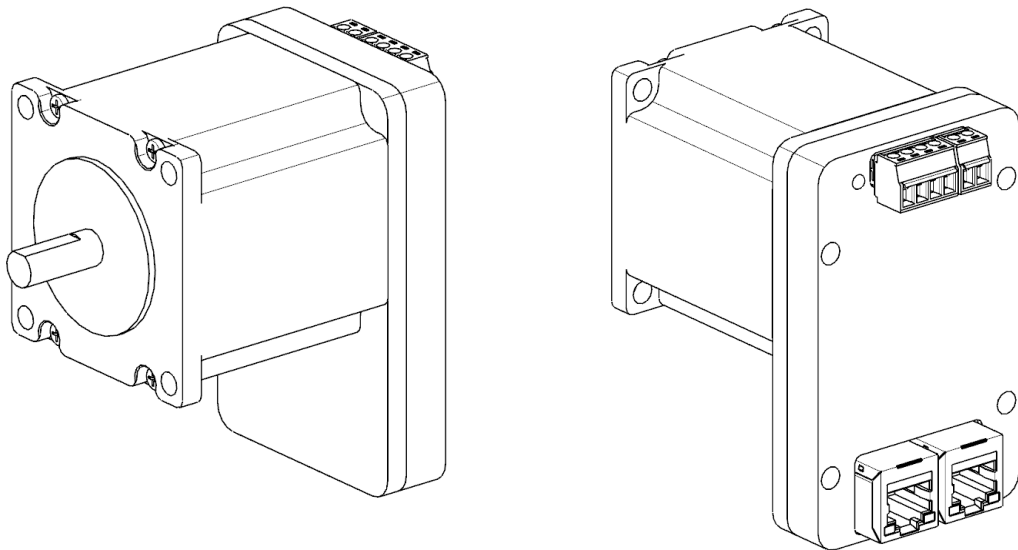

产品外形图

3.3.4 旋转方向定义

旋转方向可通过配置软件选择取反，在出厂默认不取反的情况下，正反方向的定义如下：

1、**正方向**：面对电机的出轴端，电机轴顺时针方向为正方向；

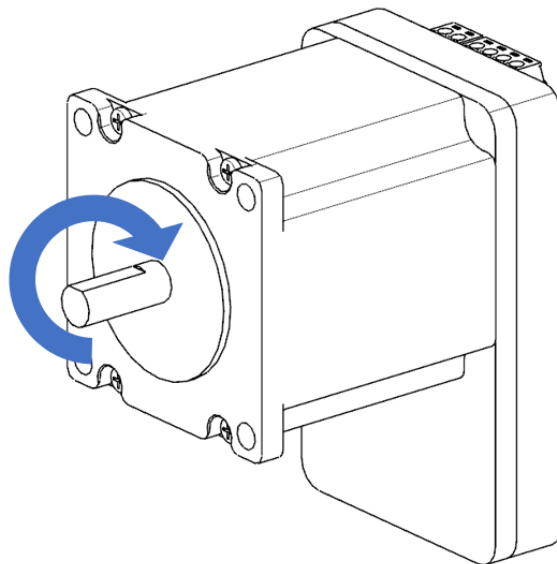

正方向示意图

2、**负方向**：面对电机的出轴端，电机轴逆时针方向为负方向；

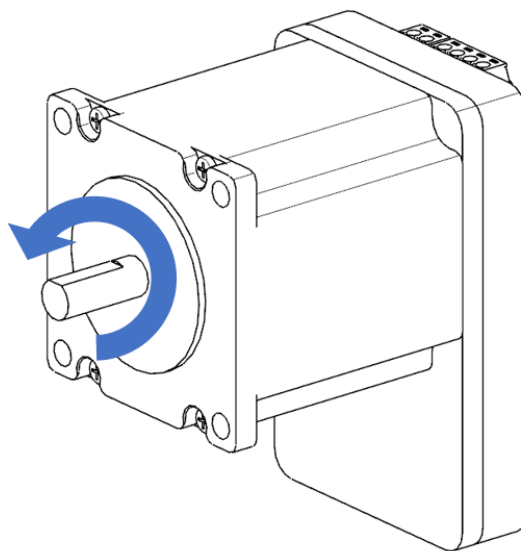



负方向示意图

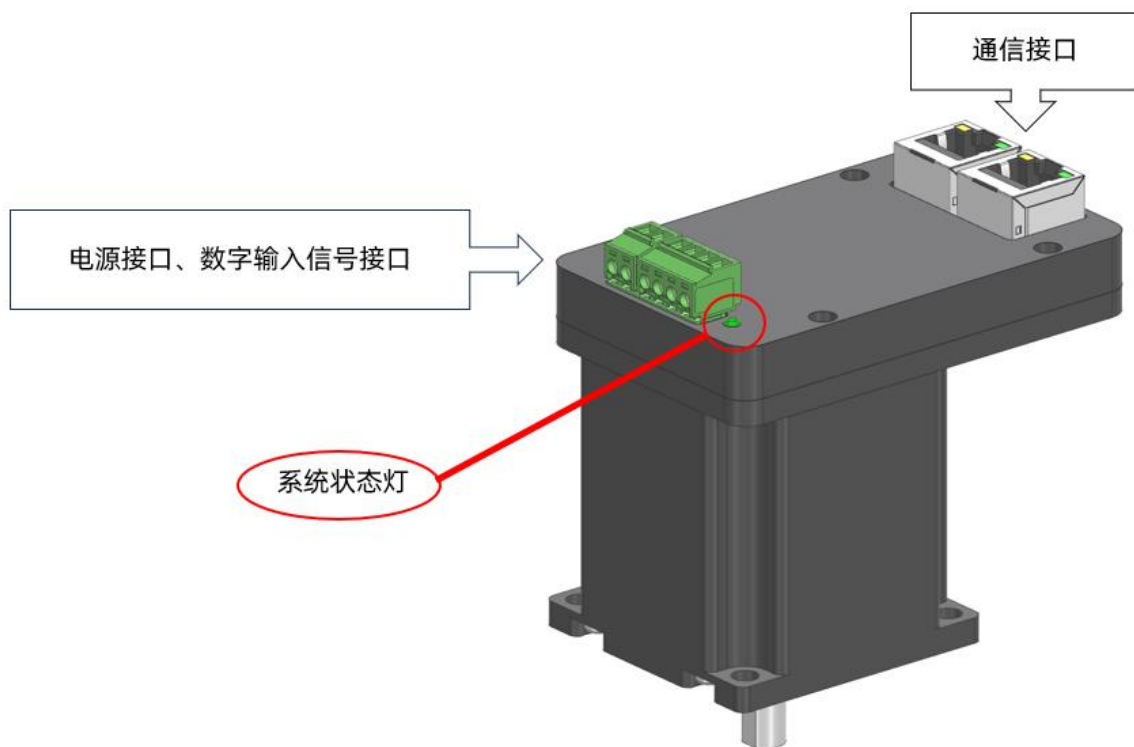

3.3.5 LED 指示

LED 灯信息: 在电机底部有一个系统状态指示灯 (绿色 LED 灯), 方便诊断

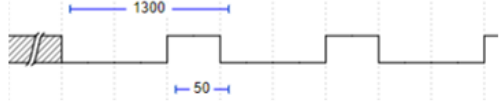
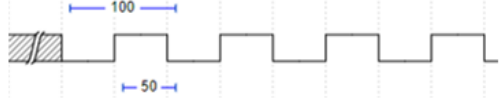
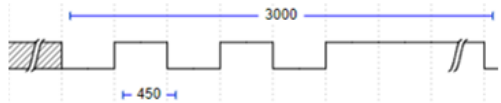

LED灯	说明	图示(单位:ms)
 <p>状态灯</p>	1、常亮。 控制器已连接通信正常	
	2、间隔短闪。 无控制器连接	
	3、快闪。 设备初始化	
	4、周期闪烁三次后恢复 1/2/3状态。 查找设备功能	

3.3.6 包装清单

名称	数量	图示
电机本体	1 件	 A black, rectangular motor housing with a circular opening on the front face and a mounting bracket on the top.
2P 3.81 拔插端子 (默认安装在电机上)	1 件	 A green, rectangular terminal block with two pins on top and two slots on the bottom.
4P 3.81 拔插端子 (默认安装在电机上)	1 件	 A green, rectangular terminal block with four pins on top and four slots on the bottom.

3.4 开箱及存储

开箱注意事项:

- 开箱前应检查包装外观完整，无因物流运输造成的破损。
- 开箱后按照相应的产品包装清单核对是否有缺件错件。
- 若发现以上问题，请及时联系经销商。

开箱后如短时间内不使用，应按原厂包装存储产品。

存储条件	描述
温度	-20°C ~ 60°C
湿度	< 90% ， 无凝露， 无冻结

3.5 保修期与保修范围

1、 保修期

自购买之日起,本产品享有为期 1 年的有限保修服务。在保修期内,因产品质量问题导致的故障,我们将免费提供维修或更换服务。超过保修期的,将收取维修费用。

2、 不在保修范围内的情况

- 产品被私自改造、拆解;
- 随时间引起的外观老化;
- 机械上无影响的声音现象;
- 因不当使用、存储或运输造成的损坏;
- 不可抗力因素(自然灾害、地震、雷击)引起的损坏;

3、 保修/维修服务流程

- 申请保修/维修:联系厂家/经销商,并提供故障描述,判断故障处理是否需要返厂。
- 产品寄回:若需要进行返厂保修/维修的,根据厂家/经销商提供的地址进行寄回,并附带用户信息、故障描述,寄回地址以便维修。
- 评估与处理:产品寄回后,我们将尽快对保修/维修申请进行评估,对于在保修期范围内的产品,进行免费的维修或更换服务,对于超过保修期的,将根据产品具体情况进行维修报价评估。
- 完成服务:保修/维修完成后,我们会根据用户提供的地址进行寄回。

4、 其他说明

- 保修期内的维修或更换服务均不延长原保修期限。
- 若产品经多次维修仍无法正常使用,且符合国家“三包”规定,我们将根据相关规定予以更换或退货。
- 我们保留对本保修条款的最终解释权。

4 接线

4.1 MD-42 系列

4.1.1 接口及系统连接

本系列产品接口如下：

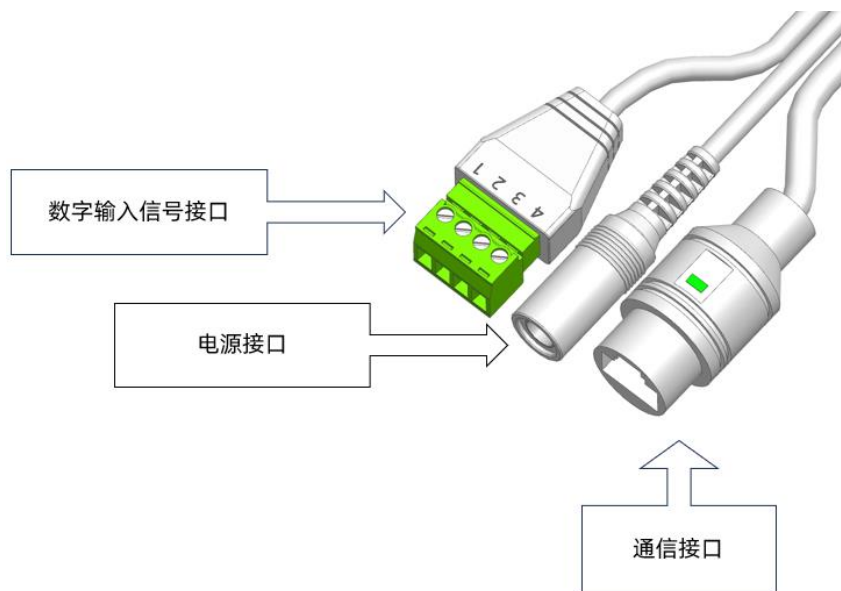

接口示意图

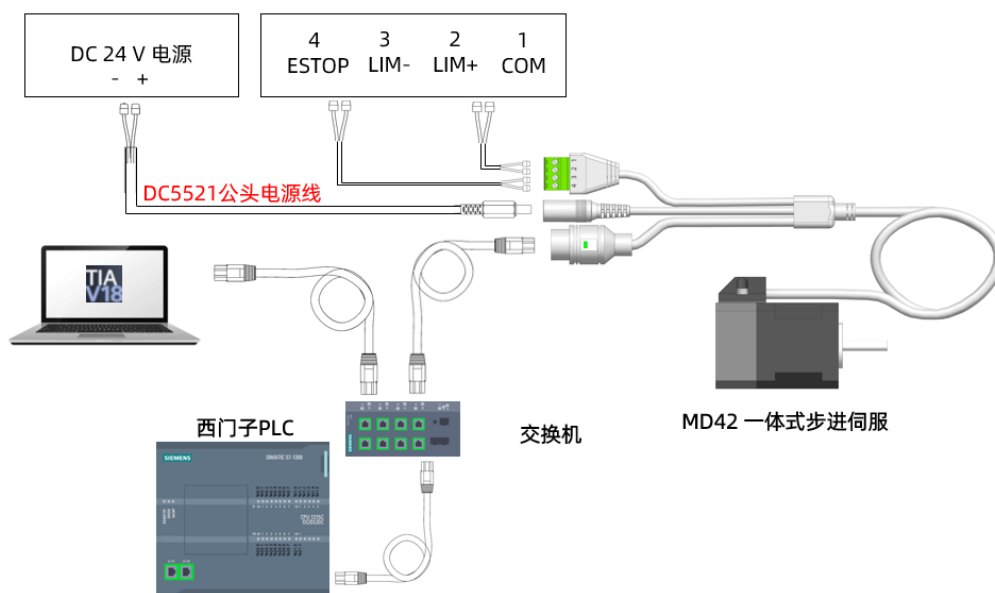

系统连接

4.1.2 电源接口

电源接口：该接口采用 DC 电源母头 5521，供电电压范围为：DC 24V ($\pm 15\%$)。



示意图	端子号	信号名称	描述
	1	+24 V	电源, DC 24 V
	2	M	电源, DC 0 V

4.1.3 通信接口

通信接口：采用标准 RJ45 母头。

示意图	端子号	信号名称	描述
	1	TXP	发送数据+
	2	TXN	发送数据-
	3	RXP	接收数据+
	4		
	5		
	6	RXN	接收数据-
	7		
	8		

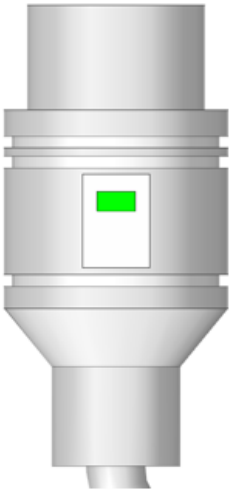
LED 灯信息：通信接口上附带一个系统状态指示灯（绿色 LED 灯），方便诊断

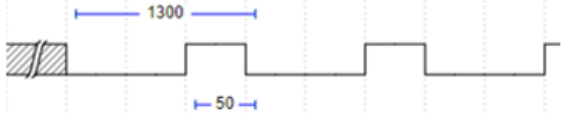
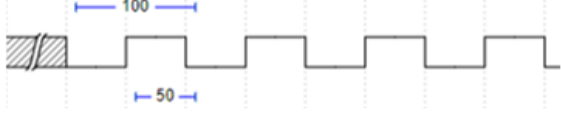
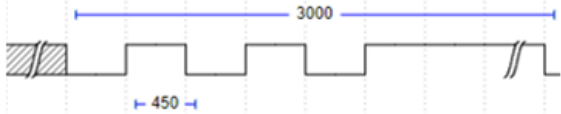
LED灯	说明	图示(单位:ms)
	1、常亮。 控制器已连接通信正常	
	2、间隔短闪。 无控制器连接	
	3、快闪。 设备初始化	
	4、周期闪烁三次后恢复 1/2/3状态。 查找设备功能	

网络拓扑示意图

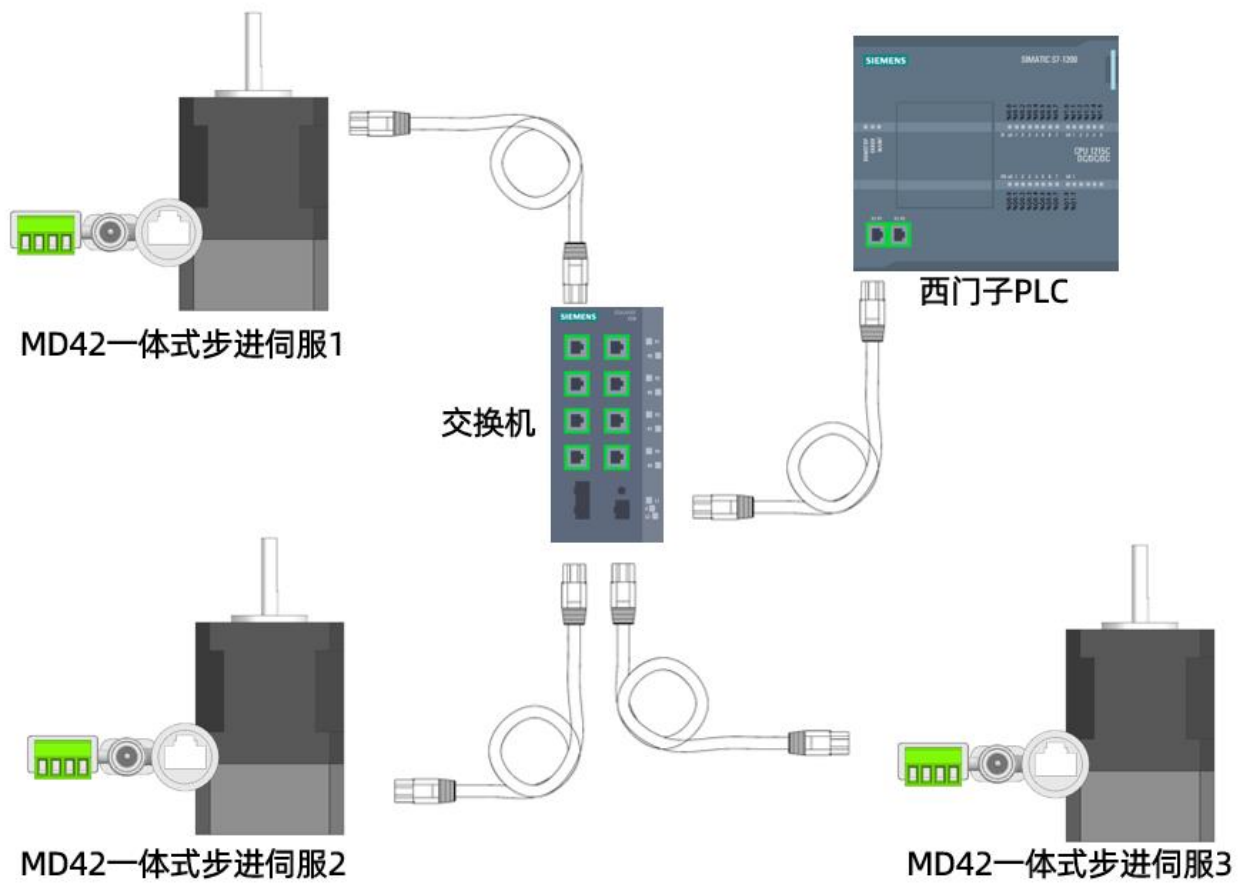

星型网络拓扑

4.1.4 数字输入信号接口

数字输入信号接口：该接口采用 3.81mm 拔插式接线端子，可接入 3 个内部数字量输入信号。关于这些信号的详细信息，请参见下表。

示意图	端子号	信号名称	描述
	1	COM	数字量输入信号公共端，支持 PNP / NPN 类型。
	2	LIM+	正方向行程限位开关（正限位）
	3	LIM-	负方向行程限位开关（负限位）
	4	ESTOP	紧急停止信号，当接收到此信号时，设备立即停止动作。 注意：急停信号为常闭信号。 要使用这个功能，需要将参数表“急停功能使能”设置为1。

数字量输入信号支持 PNP 与 NPN 两种接线方式。

示例图如下：

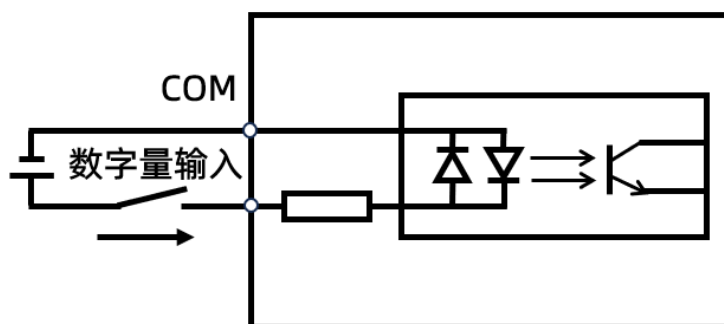

PNP接线

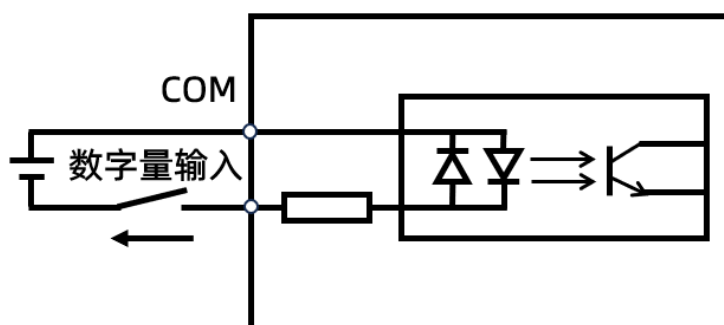

NPN接线

4.2 MD-57 系列

4.2.1 接口及系统连接

本系列产品接口如下：

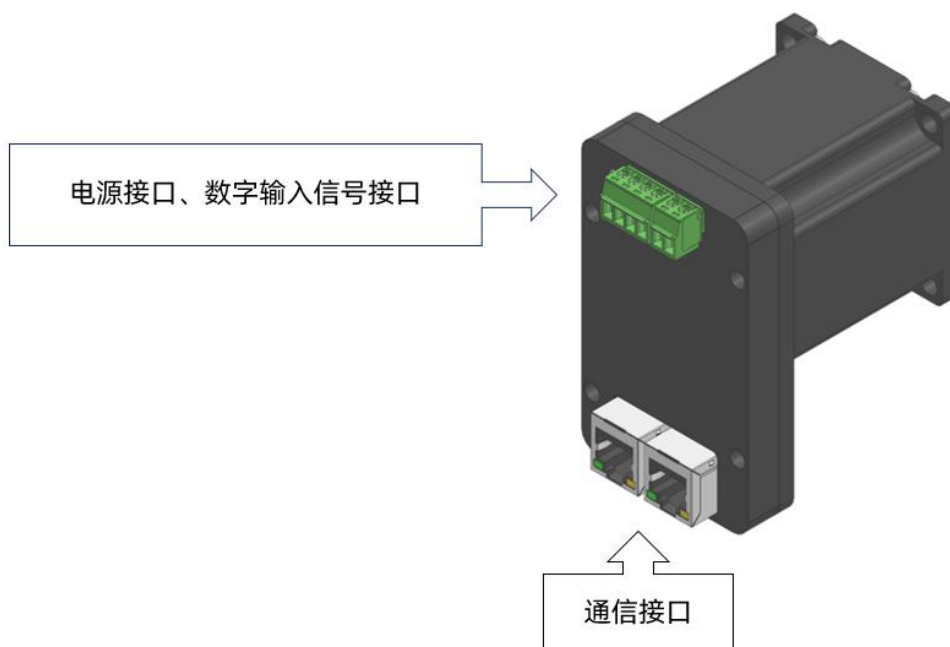

接口示意图

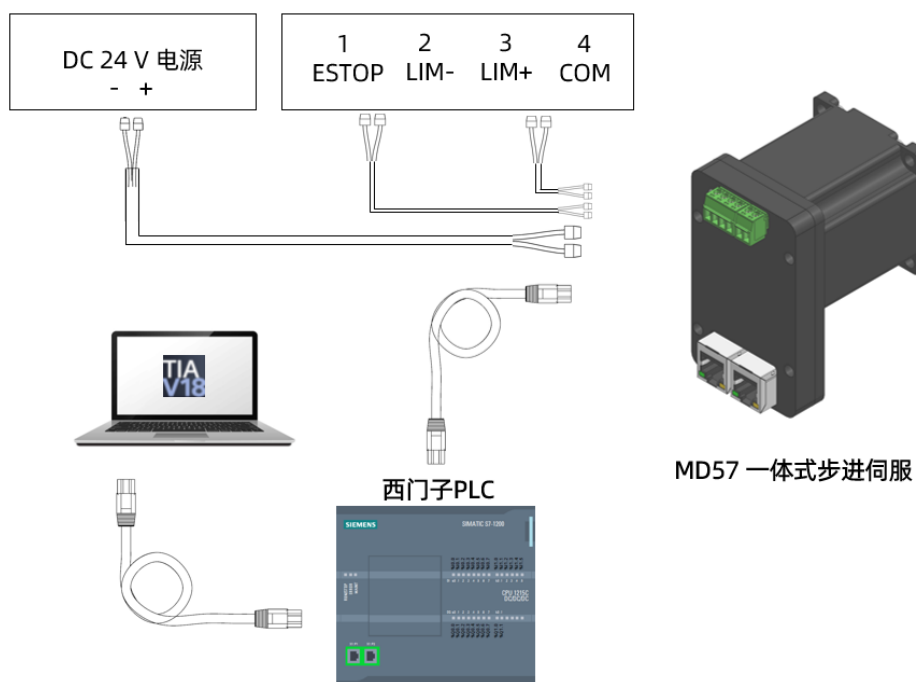

系统连接

4.2.2 电源接口

电源接口：接口采用 2P 3.81 拔插端子 DC 电源母头 5521，供电电压范围为：DC 24V（±15%）。

示意图	端子号	信号名称	描述
	1	+24 V	电源，DC 24 V
	2	M	电源，DC 0 V

4.2.3 通信接口

通信接口：采用双 RJ45 接口，内置交换机芯片。

示意图	编号	名称	描述
	1	PORT1	RJ45网络插线座1
	2	PORT2	RJ45网络插线座2

4.2.4 数字输入信号接口

数字输入接口：该接口采用 3.81mm 拔插式接线端子，可接入 3 个内部数字量输入信号，内置双向光耦，支持 PNP/NPN 接法。

示意图	端子号	信号名称	描述
	1	ESTOP	紧急停止信号，当接收到此信号时，设备立即停止动作。
	2	LIM-	负方向行程限位开关（负限位）
	3	LIM+	正方向行程限位开关（正限位）
	4	COM	数字量输入信号公共端，支持 PNP 和 NPN 类型。

5 调试

5.1 注意事项

使用本产品时，请先仔细阅读接线章节，并检查无遗漏与接线错误后方可开始调试。

在设备运行期间，请注意以下事项：

- 1、确保人员和物品不在设备及其所控制的机械运动范围内。设置物理屏障或警告标志，提醒他人远离工作区域。
- 2、除非必要，否则不要直接接触正在运行的设备。如果必须接触，请务必关闭电源并确认设备完全停止工作。
- 3、确保设备周围的空气流通畅通，有良好的散热环境。
- 4、确保设备电缆固定牢固，避免电缆被拉扯或挤压，以免损坏
- 5、非技术人员不得随意操作设备或调整其参数。
- 6、在设备通电状态下，禁止进行任何可能引起短路的操作。
- 7、检查设备和连接的固定件，确保没有松动或者损坏。

5.2 调试软件

5.2.1 软件说明

您可以使用辅助工具 'BCZY DTools'的辅助工具来进行试运行操作。该辅助工具可以在 Windows 操作系统上进行安装并运行。它能够通过以太网线路与设备建立连接。借助此工具，您可以调整设备的驱动参数，并且实时监控其工作状态。

操作系统

Windows 7 32 位（专业版）

Windows 7 64 位（专业版）

Windows 10 32 位（专业版）

Windows 10 64 位（专业版）

说明

最小屏幕分辨率要求为 1680×1050。

5.2.2 必要的管理员权限

在**默认情况**下，本软件会**自动以管理员身份运行**。如果未能成功获取管理员权限，启动时将会弹出提示窗提醒您手动开启管理员权限。请按照提示操作以确保软件正常运行。

否(N) -> 右键软件 -> 以管理员身份运行(A)

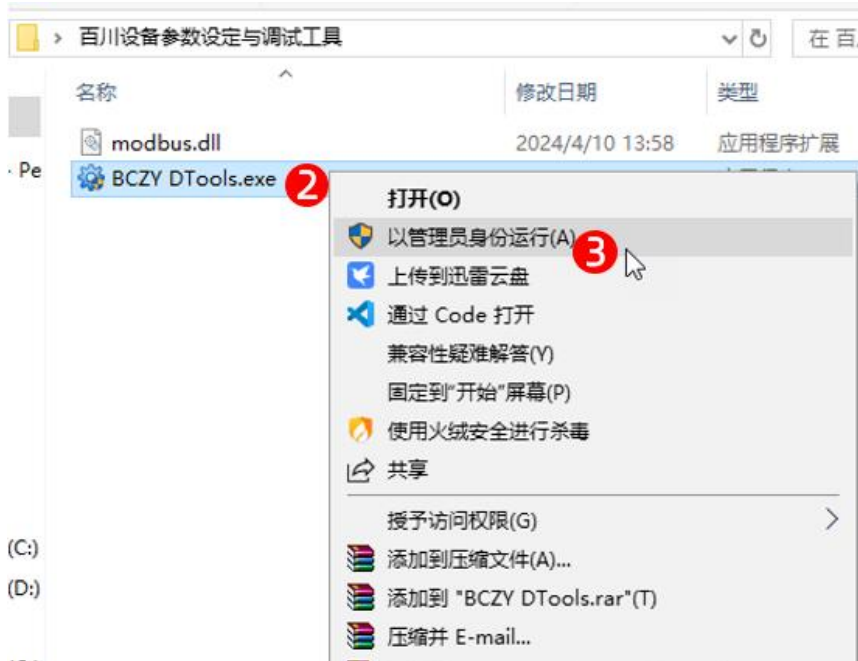
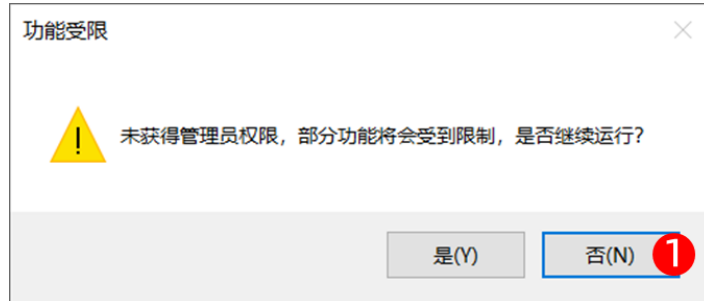

5.2.3 防火墙设置

电脑防火墙开启的情况下，本软件在首次启动搜索时会被拦截，为了正常使用本软件的设备发现功能，请允许该应用通过防火墙。

勾选专用网络-> 勾选公用网络-> 允许访问 (A)

由于第一次搜索被防火墙拦截，允许通过防火墙后，用户需再次搜索。

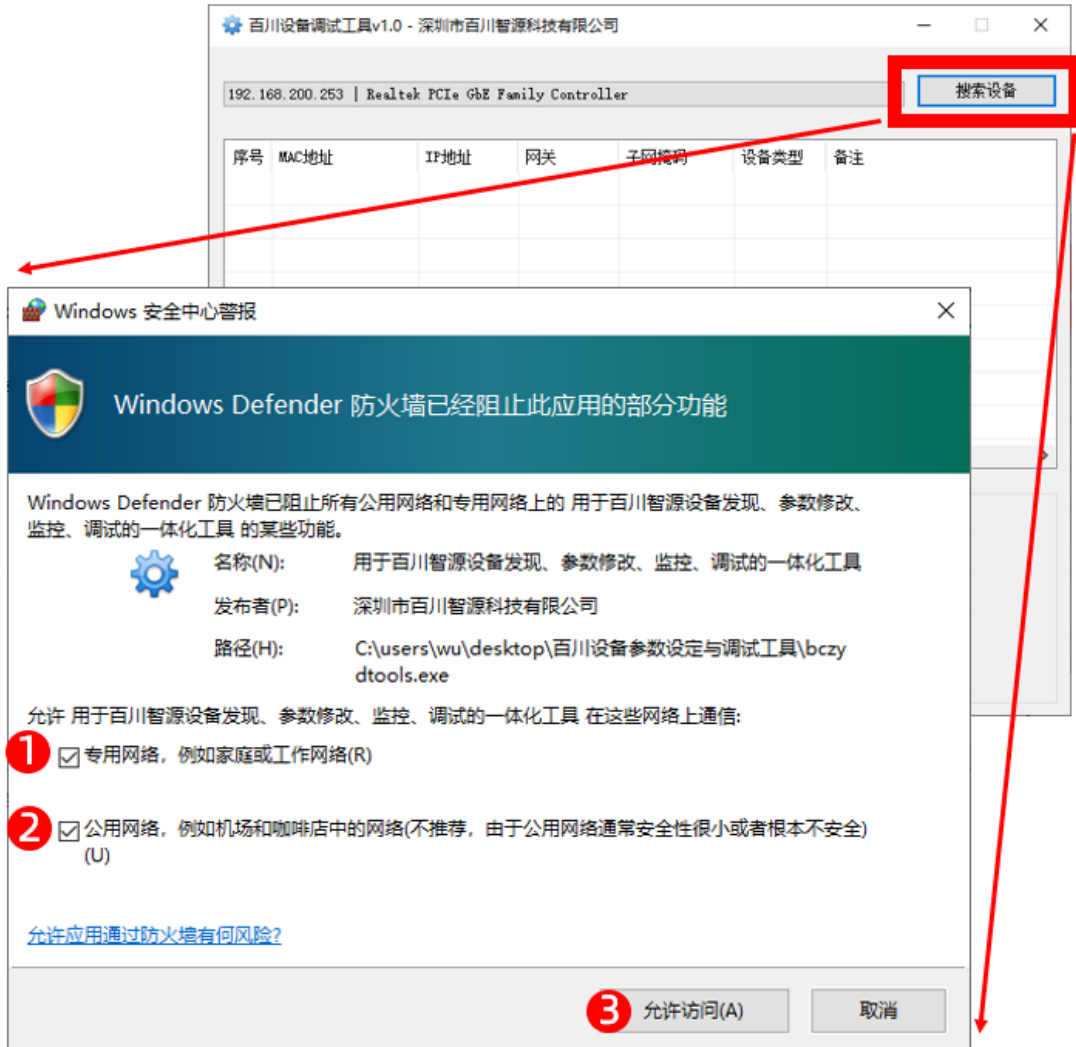

5.2.4 主窗口

- 1、 **网卡选择下拉框**：提供计算机内所有可用网卡的选择，用户可根据需求挑选。
- 2、 **搜索设备按钮**：按钮点击后，软件会通过当前选择的网卡寻找网络中的设备。
- 3、 **设备信息显示列表**：显示搜索结果，用户可从中选取需要操作的设备。
- 4、 **网络参数设置框**：用户在此处调整设备的 IP 地址、网关和子网掩码，确保设备能在不同的网络环境中正常工作。
- 5、 **LED 闪烁勾选框**：勾选后，所选设备的状态指示灯将闪烁，作为操作反馈。
- 6、 **设置键**：保存并应用新设定的网络参数，更新设备配置。
- 7、 **重置网络参数键**：仅针对网络配置参数，点击后将设备的网络设置恢复至出厂预设值。
- 8、 **设备调试键**：进入调试模式，对设备性能进行检测和校验。



5.2.5 调试窗口

5.2.5.1 界面概览

- 1、 **电机控制中心**：用于控制电机运动和监控电机状态。
- 2、 **多功能选项卡面板**：用于设置电机参数、查看报文信息、记录运动轨迹、升级固件。
- 3、 **设备状态一览**：用于显示设备的基本信息和通信状况。

MD_4260_PN调试窗口

运动模式: 电机失能

设定位置: 0 当前位置: 0

设定速度: 0 当前速度: -101

当前负载: 0

跟随误差: 0

速度倍率: [Slider]

加速度倍率: [Slider]

轴静止 []

斜坡位置到达 []

斜坡速度到达 []

正在回零 []

正限位开关信号激活 []

负限位开关信号激活 []

急停开关信号激活 []

警告:未回零点(零点未设置)

警告:到达正限位 []

警告:到达负限位 []

警告:到达软正限位 []

警告:到达软负限位 []

警告:驱动电机高温报警 (120°C) []

警告:电机未校准 []

报警:到达(软/硬)限位 []

故障:急停激活 []

故障:跟随误差过大 []

故障:堵转错误 []

故障:未校准电机 []

故障:电机a相对地短路 []

故障:电机b相对地短路 []

故障:驱动电路过温保护 (150°C) []

空闲

参数号	参数组	参数名	描述	设置值	当前值	出厂值	最小值	最大值	单位	修改方式	生效方式
10	基本参数	calibration_mode_torque_limit	校准模式转矩限制	60	60	100	1	100	%	直接修改	立即生效
12	基本参数	normal_mode_torque_limit	常规模式转矩限制	100	100	100	1	100	%	直接修改	立即生效
14	基本参数	velocity_limit	速度限制	3000	3000	3000	1	6000	rpm	直接修改	立即生效
16	基本参数	acceleration_limit	加速度限制	76800000	76800000	76800000	1	76800000	rpm ²	直接修改	立即生效
18	基本参数	acceleration	加速度	768000	768000	768000	1	76800000	rpm ²	直接修改	立即生效
20	基本参数	lu	负载每圈负载	10000	10000	10000	1	1048576	lu	直接修改	立即生效
22	基本参数	gear_ratio_n1	齿轮比n1	1	1	1	1	1048576		直接修改	立即生效
24	基本参数	gear_ratio_n2	齿轮比n2	1	1	1	1	1048576		直接修改	立即生效
26	基本参数	velocity_lpf_exp	速度滤波指数	5	5	5	1	8	1/2 ⁿ	直接修改	立即生效
28	基本参数	invert_direction	取反运动方向	0=不取反	0=不取反	0	0	1		直接修改	下次使能生效
34	闭环控制参数	controller_preferences	控制器偏好	3	3	3	0	7		直接修改	立即生效
36	闭环控制参数	ladrc_bandwidth	LADRC带宽	240	240	240	100	1200	hz	直接修改	立即生效
38	闭环控制参数	ladrc_b0	LADRC增益系数	120000	120000	45000	1	2147483647		直接修改	立即生效
40	闭环控制参数	torque_lfwh	转矩前馈	150	150	150	0	65535	%	直接修改	立即生效
42	闭环控制参数	dynamic_bandwidth_enable	LADRC动态带宽使能	1=开启	1=开启	1	0	1		直接修改	立即生效
44	闭环控制参数	dynamic_bandwidth	LADRC动态带宽	400	400	400	100	1200	hz	直接修改	立即生效
46	闭环控制参数	fv_velocity	弱磁介入速度	300	300	300	1	6000	rpm	直接修改	立即生效
48	弱磁控制参数	fv_gain	弱磁增益	5500	5500	5500	1	65535	1/n	直接修改	立即生效
50	电液控制参数	chopper_toff	电液控制器 爆震漏时间	3	3	3	2	4		直接修改	重启生效
52	电液控制参数	chopper_hstbt	电液控制器 迟滞窗口上限	2	2	2	0	7		直接修改	重启生效
54	电液控制参数	chopper_hstbt	电液控制器 迟滞窗口下限	4	4	4	0	11		直接修改	重启生效
56	电液控制参数	chopper_tbt	电液控制器 电液采样滞影时间	2	2	2	0	3		直接修改	重启生效
58	电液参数	current_derating	电流降额	0	0	0	0	5		直接修改	重启生效
62	信号参数	target_reached_threshold	位置到达阈值	-10	-10	-10	-16	16	2 ⁿ rev	直接修改	立即生效
64	信号参数	target_reached_time	位置到达驻留时间	10	10	10	1	65535	ms	直接修改	立即生效
66	信号参数	velocity_reached_threshold	速度到达阈值	10	10	10	1	6000	rpm	直接修改	立即生效
68	信号参数	velocity_reached_time	速度到达驻留时间	10	10	10	1	65535	ms	直接修改	立即生效
70	信号参数	standstill_threshold	零速阈值	2	2	2	1	6000	rpm	直接修改	立即生效
72	信号参数	standstill_time	零速驻留时间	10	10	10	1	65535	ms	直接修改	立即生效
74	保护功能参数	following_error_monitoring_enable	跟踪误差监视使能	1=开启	1=开启	1	0	1		直接修改	立即生效
76	保护功能参数	following_error_threshold1	跟踪误差阈值1	-6	-6	-6	-16	16	2 ⁿ rev	直接修改	立即生效
78	保护功能参数	following_error_threshold2	跟踪误差阈值2	-2	-2	-2	-16	16	2 ⁿ rev	直接修改	立即生效
80	保护功能参数	following_error_time	跟踪误差过大驻留时间	200	200	200	1	65535	ms	直接修改	立即生效
82	保护功能参数	stall_protect_enable	堵转保护使能	0=关闭	0=关闭	0	0	1		直接修改	立即生效
84	保护功能参数	stall_protect_velocity_threshold	堵转保护速度阈值	2	2	2	1	6000	rpm	直接修改	立即生效
86	保护功能参数	stall_protect_torque_threshold	堵转保护转矩阈值	98	98	98	1	100	%	直接修改	立即生效
88	保护功能参数	stall_protect_time	堵转保护时间	200	200	200	1	65535	ms	直接修改	立即生效
90	保护功能参数	limit_protect_enable	限位保护使能	0=关闭	0=关闭	0	0	1		直接修改	立即生效

上传 读取 保存 上传并保存 参数恢复出厂 重置 参数导入 参数导出

设备MAC: AA:13:14:00:00:00 设备IP: 192.168.0.244 设备温度: 28 上电次数: 545 连接状态: 已连接 直流母线电压: 23.49 驱动芯片温度: 33

5.2.5.2 电机控制中心

5.2.5.2.1 控制区

- 1、 **运动模式：** 用于切换运动模式，模式包含电机失能、相对位置模式、绝对位置模式、速度模式、主动回零模式、零点设置模式、程序块模式、点动模式、寸动模式。
- 2、 **设定位置：** 用于设定电机的目标位置，单位为 lu。
- 3、 **设定速度：** 用于设定电机的目标速度，单位为 lu/s。
- 4、 **Jog+：** 用于电机点动/寸动模式下让电机往正方向点动/寸动。
- 5、 **Jog-：** 用于电机点动/寸动模式下让电机往负方向点动/寸动。
- 6、 **启动任务：** 用于电机多数运动模式(相对位置、绝对位置、速度模式、主动回零模式、零点设置模式、程序块模式)的启动，启动任务时，将运动模式、目标位置与目标速度传入电机。
- 7、 **暂停任务：** 用于暂停当前运行的任务，当暂停任务指示灯为红色时，表示当前运行的任务暂停中，当暂停任务指示灯为绿色时，表示不暂停当前任务。
- 8、 **取消任务：** 用于取消当前运行的任务，当取消任务指示灯为红色时，取消所有任务，当取消任务指示灯为绿色时，表示不取消任务，允许任务运行。
- 9、 **传输方式：** 用于选择设定值单步传输或连续传输。
- 10、 **确认错误：** 用于复位所有故障标志位。

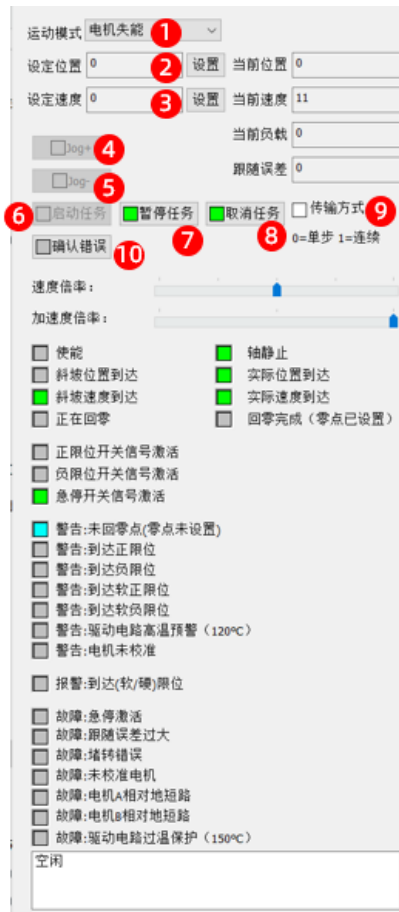

5.2.5.2.2 显示区

- 1、 **当前位置**：用于反馈当前电机相对于零点坐标系的相对位置值，单位为 lu。
- 2、 **当前速度**：用于反馈当前电机的旋转速度值，单位为 lu/s。
- 3、 **当前负载**：用于反馈当前电机的负载百分比。
- 4、 **跟随误差**：用于反馈电机运行时的期望位置轨迹（规划路径）与实际位置轨迹之间的偏差。



5.2.5.2.3 调节区

1、速度倍率调节：用于调节速度倍率，范围(0~199%)，所有模式有效。

2、加速度倍率调节：用于调节加速度倍率，范围(0~100%)，不适用于主动回零、点动及寸动模式。

跟随误差：用于反馈电机运行时的期望位置轨迹（规划路径）与实际位置轨迹之间的偏

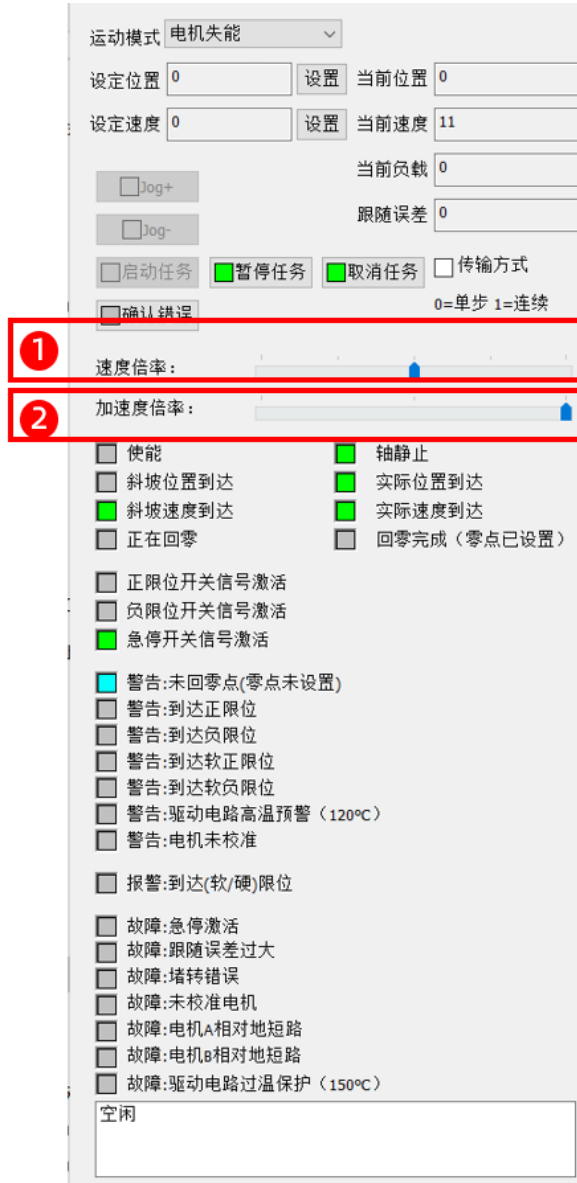

5.2.5.2.4 状态区

- 1、 **运动状态指示区**：用于显示电机运动相关的信号状态。
- 2、 **开关信号状态指示区**：显示开关信号的状态，如正限位、负限位、急停开关等是否被激活。
- 3、 **异常信号指示区**：用于显示三种不同级别（警告/报警/故障）的异常信息。
- 4、 **主动回零模式状态指示区**：用于显示主动回零模式下各阶段状态与错误信息。

运动模式

设定位置 设置 当前位置

设定速度 设置 当前速度

Jog+ 当前负载

Jog- 跟随误差

启动任务 暂停任务 取消任务 传输方式

确认错误 0=单步 1=连续

速度倍率:

加速度倍率:

1

<input type="checkbox"/> 使能	<input checked="" type="checkbox"/> 轴静止
<input type="checkbox"/> 斜坡位置到达	<input checked="" type="checkbox"/> 实际位置到达
<input checked="" type="checkbox"/> 斜坡速度到达	<input checked="" type="checkbox"/> 实际速度到达
<input type="checkbox"/> 正在回零	<input type="checkbox"/> 回零完成 (零点已设置)

2

<input type="checkbox"/> 正限位开关信号激活
<input type="checkbox"/> 负限位开关信号激活
<input checked="" type="checkbox"/> 急停开关信号激活

3

<input checked="" type="checkbox"/> 警告:未回零点(零点未设置)
<input type="checkbox"/> 警告:到达正限位
<input type="checkbox"/> 警告:到达负限位
<input type="checkbox"/> 警告:到达软正限位
<input type="checkbox"/> 警告:到达软负限位
<input type="checkbox"/> 警告:驱动电路高温预警 (120°C)
<input type="checkbox"/> 警告:电机未校准
<input type="checkbox"/> 报警:到达(软/硬)限位
<input type="checkbox"/> 故障:急停激活
<input type="checkbox"/> 故障:跟随误差过大
<input type="checkbox"/> 故障:堵转错误
<input type="checkbox"/> 故障:未校准电机
<input type="checkbox"/> 故障:电机A相对地短路
<input type="checkbox"/> 故障:电机B相对地短路
<input type="checkbox"/> 故障:驱动电路过温保护 (150°C)

4

空闲

5.2.5.3多功能选项卡面板

- 1、 **参数表**: 用于查看与操作设备寄存器参数的相关信息。
- 2、 **报文信息**: 用于显示输入输出报文状态。
- 3、 **波形录制**: 用于录制设备运动的轨迹。
- 4、 **固件升级**: 用于设备固件升级。

1	2	3	4											
参数表	报文信息	波形录制	固件升级											
参数号P	参数组	参数名	描述	设置值	当前值	出厂值	最小值	最大值	单位	修改方式	生效方式			
10	基本参数	calibration_mode_torque_limit	校准模式转矩限制	60	60	100	1	100	%	直接修改	立即生效			
12	基本参数	normal_mode_torque_limit	常规模式转矩限制	100	100	100	1	100	%	直接修改	立即生效			
14	基本参数	velocity_limit	速度限制	3000	3000	3000	1	6000	rpm	直接修改	立即生效			
16	基本参数	acceleration_limit	加速度限制	76800000	76800000	76800000	1	76800000	rpm ²	直接修改	立即生效			
18	基本参数	acceleration	加速度	768000	768000	768000	1	76800000	rpm ²	直接修改	立即生效			
20	基本参数	lu	负载每圈LU数	10000	10000	10000	1	1048576	lu	直接修改	立即生效			
22	基本参数	gear_ratio_n1	齿轮比n1	1	1	1	1	1048576		直接修改	立即生效			
24	基本参数	gear_ratio_n2	齿轮比n2	1	1	1	1	1048576		直接修改	立即生效			
26	基本参数	velocity_lpf_exp	速度滤波指数	5	5	5	1	8	1/2 ⁿ	直接修改	立即生效			
28	基本参数	invert_direction	取反运动方向	0=不取反	0=不取反	0	0	1		直接修改	下次使能生效			
30														
32														
34	闭环控制参数	controller_preferences	控制器偏好	3	3	3	0	7		直接修改	立即生效			
36	闭环控制参数	ladrc_bandwidth	LADRC带宽	240	240	240	100	1200	hz	直接修改	立即生效			
38	闭环控制参数	ladrc_b0	LADRC滤波系统系数	120000	120000	45000	1	2147483647		直接修改	立即生效			
40	闭环控制参数	torque_fw	转矩前馈	150	150	150	0	65535	%	直接修改	立即生效			
42	闭环控制参数	dynamic_bandwidth_enable	LADRC动态带宽使能	1=开启	1=开启	1	0	1		直接修改	立即生效			
44	闭环控制参数	dynamic_bandwidth	LADRC动态带宽	400	400	400	100	1200	hz	直接修改	立即生效			
46	弱磁控制参数	fw_velocity	弱磁介入速度	300	300	300	1	6000	rpm	直接修改	立即生效			
48	弱磁控制参数	fw_gain	弱磁增益	5500	5500	5500	1	65535	1/n	直接修改	立即生效			
50	电流控制参数	chopper_toff	电流控制器 慢衰减时间	3	3	3	2	4		直接修改	重启生效			
52	电流控制参数	chopper_hstrt	电流控制器 迟滞窗口上限	2	2	2	0	7		直接修改	重启生效			
54	电流控制参数	chopper_hend	电流控制器 迟滞窗口下限	4	4	4	0	11		直接修改	重启生效			
56	电流控制参数	chopper_tbl	电流控制器 电流采样消影时间	2	2	2	0	3		直接修改	重启生效			
58	电流参数	current_derating	电流降额	0	0	0	0	5		直接修改	重启生效			
60														
62	信号参数	target_reached_threshold	位置到达阈值	-10	-10	-10	-16	16	2 ⁿ rev	直接修改	立即生效			
64	信号参数	target_reached_time	位置到达驻留时间	10	10	10	1	65535	ms	直接修改	立即生效			
66	信号参数	velocity_reached_threshold	速度到达阈值	10	10	10	1	6000	rpm	直接修改	立即生效			
68	信号参数	velocity_reached_time	速度到达驻留时间	10	10	10	1	65535	ms	直接修改	立即生效			
70	信号参数	standstill_threshold	零速阈值	2	2	2	1	6000	rpm	直接修改	立即生效			
72	信号参数	standstill_time	零速驻留时间	10	10	10	1	65535	ms	直接修改	立即生效			
74	保护功能参数	following_error_monitoring_enable	跟随误差监视使能	1=开启	1=开启	1	0	1		直接修改	立即生效			
76	保护功能参数	following_error_threshold1	跟随误差阈值1	-6	-6	-6	-16	16	2 ⁿ rev	直接修改	立即生效			
78	保护功能参数	following_error_threshold2	跟随误差阈值2	-2	-2	-2	-16	16	2 ⁿ rev	直接修改	立即生效			
80	保护功能参数	following_error_time	跟随误差过大驻留时间	200	200	200	1	65535	ms	直接修改	立即生效			
82	保护功能参数	stall_protect_enable	堵转保护使能	0=关闭	0=关闭	0	0	1		直接修改	立即生效			
84	保护功能参数	stall_protect_velocity_threshold	堵转保护速度阈值	2	2	2	1	6000	rpm	直接修改	立即生效			
86	保护功能参数	stall_protect_torque_threshold	堵转保护转矩阈值	98	98	98	1	100	%	直接修改	立即生效			
88	保护功能参数	stall_protect_time	堵转保护时间	200	200	200	1	65535	ms	直接修改	立即生效			
90	保护功能参数	limit_protect_enable	硬限位保护使能	0=关闭	0=关闭	0	0	1		直接修改	立即生效			

上传
读取
保存
上传并保存
参数恢复出厂
重启
参数导入
参数导出

5.2.5.3.1 参数表

- 1、 **设置值：**“设置值”列可供用户修改。
- 2、 **上传：**将参数表“设置值”列上传到设备(掉电丢失)。
- 3、 **读取：**将设备参数读取到参数表。
- 4、 **保存：**将当前值保存到设备存储器中(掉电保持)。
- 5、 **上传并保存：**将“设置值”上传到设备，并且保存到设备存储器(掉电保持)。
- 6、 **参数恢复出厂：**设备的所有参数恢复出厂设置值。
- 7、 **重启：**设备重启。
- 8、 **参数导入：**导入配置文件(覆盖设置值)。
- 9、 **参数导出：**导出配置文件(仅当前值)。

参数号	参数组	参数名	描述	设置值	当前值	出厂值	最小值	最大值	单位	修改方式	生效方式
10	基本参数	calibration_mode_torque_limit	校准模式转矩限制	60	60	100	1	100	%	直接修改	立即生效
12	基本参数	normal_mode_torque_limit	常规模式转矩限制	100	100	100	1	100	%	直接修改	立即生效
14	基本参数	velocity_limit	速度限制	6000	6000	3000	1	6000	rpm	直接修改	立即生效
16	基本参数	acceleration_limit	加速度限制	1280000	1280000	76800000	1	76800000	rpm ²	直接修改	立即生效
18	基本参数	acceleration	加速度	768000	768000	768000	1	76800000	rpm ²	直接修改	立即生效
20	基本参数	lu	负载每圈LU数	10000	10000	10000	1	1048576	lu	直接修改	立即生效
22	基本参数	gear_ratio_n1	齿轮比n1	1	1	1	1	1048576		直接修改	立即生效
24	基本参数	gear_ratio_n2	齿轮比n2	1	1	1	1	1048576		直接修改	立即生效
26	基本参数	velocity_lpf_exp	速度滤波指数	6	6	5	1	8	1/2 ⁿ	直接修改	立即生效
28	基本参数	invert_direction	取反运动方向	0=不取反	0=不取反	0	0	1		直接修改	下次使能生效
30											
32											
34	闭环控制参数	controller_preferences	控制器偏好	3	3	3	0	7		直接修改	立即生效
36	闭环控制参数	ladrc_bandwidth	LADRC带宽	240	240	240	100	1200	hz	直接修改	立即生效
38	闭环控制参数	ladrc_b0	LADRC被控系统系数	33000	33000	45000	1	2147483647		直接修改	立即生效
40	闭环控制参数	torque_ffw	转矩前馈	150	150	150	0	65535	%	直接修改	立即生效
42	闭环控制参数	dynamic_bandwidth_enable	LADRC动态带宽使能	1=开启	1=开启	1	0	1		直接修改	立即生效
44	闭环控制参数	dynamic_bandwidth	LADRC动态带宽	400	400	400	100	1200	hz	直接修改	立即生效
46	弱磁控制参数	fw_velocity	弱磁介入速度	300	300	300	1	6000	rpm	直接修改	立即生效
48	弱磁控制参数	fw_gain	弱磁增益	5500	5500	1	1	65535	1/n	直接修改	立即生效
50	电流控制参数	chopper_toff	电流控制器 慢衰减时间	3	3	3	2	4		直接修改	重启生效
52	电流控制参数	chopper_hstret	电流控制器 迟滞窗口上限	2	2	2	0	7		直接修改	重启生效
54	电流控制参数	chopper_hend	电流控制器 迟滞窗口下限	4	4	4	0	11		直接修改	重启生效
56	电流控制参数	chopper_tbi	电流控制器 电流采样消影时间	2	2	2	0	3		直接修改	重启生效
58	电流参数	current_derating	电流降额	0	0	0	0	5		直接修改	重启生效
60											
62	信号参数	target_reached_threshold	位置到达阈值	-10	-10	-10	-16	16	2 ⁿ rev	直接修改	立即生效
64	信号参数	target_reached_time	位置到达驻留时间	10	10	10	1	65535	ms	直接修改	立即生效
66	信号参数	velocity_reached_threshold	速度到达阈值	10	10	10	1	6000	rpm	直接修改	立即生效
68	信号参数	velocity_reached_time	速度到达驻留时间	10	10	10	1	65535	ms	直接修改	立即生效
70	信号参数	standstill_threshold	零速阈值	2	2	2	1	6000	rpm	直接修改	立即生效
72	信号参数	standstill_time	零速驻留时间	10	10	10	1	65535	ms	直接修改	立即生效
74	保护功能参数	following_error_monitoring_enable	跟随误差监视使能	0=关闭	0=关闭	1	0	1		直接修改	立即生效
76	保护功能参数	following_error_threshold1	跟随误差阈值1	-6	-6	-6	-16	16	2 ⁿ rev	直接修改	立即生效
78	保护功能参数	following_error_threshold2	跟随误差阈值2	-2	-2	-2	-16	16	2 ⁿ rev	直接修改	立即生效
80	保护功能参数	following_error_time	跟随误差过大驻留时间	200	200	200	1	65535	ms	直接修改	立即生效
82	保护功能参数	stall_protect_enable	堵转保护使能	0=关闭	0=关闭	0	0	1		直接修改	立即生效
84	保护功能参数	stall_protect_velocity_threshold	堵转保护速度阈值	2	2	2	1	6000	rpm	直接修改	立即生效
86	保护功能参数	stall_protect_torque_threshold	堵转保护转矩阈值	98	98	98	1	100	%	直接修改	立即生效
88	保护功能参数	stall_protect_time	堵转保护时间	200	200	200	1	65535	ms	直接修改	立即生效
90	保护功能参数	limit_protect_enable	硬限位保护使能	0=关闭	0=关闭	0	0	1		直接修改	立即生效

上传
读取
保存
上传并保存
参数恢复出厂
重启
参数导入
参数导出

5.2.5.3.2 报文信息

- 1 **输入报文显示区**：用于显示设备输入报文的值。
- 2 **输出报文显示区**：用于显示设备输出报文的值。。

输入输出报文定义可查阅[通信](#)章节。。

参数表 | 报文信息 | 波形录制 | 固件升级

输入报文	值	位																
1 当前位置(lu)	0																	
当前速度(lu/s)	-40																	
转矩利用率	0																	
跟踪误差	0																	
状态	66620	<table border="0"> <tr> <td>15</td><td>8</td><td>7</td><td>0</td> </tr> <tr> <td>□□□□□□□□</td><td>□□□□□□□□</td><td>□□□□□□□□</td><td>□□□□□□□□</td> </tr> <tr> <td>31</td><td>24</td><td>23</td><td>16</td> </tr> <tr> <td>□□□□□□□□</td><td>□□□□□□□□</td><td>□□□□□□□□</td><td>□□□□□□□□</td> </tr> </table>	15	8	7	0	□□□□□□□□	□□□□□□□□	□□□□□□□□	□□□□□□□□	31	24	23	16	□□□□□□□□	□□□□□□□□	□□□□□□□□	□□□□□□□□
15	8	7	0															
□□□□□□□□	□□□□□□□□	□□□□□□□□	□□□□□□□□															
31	24	23	16															
□□□□□□□□	□□□□□□□□	□□□□□□□□	□□□□□□□□															
回零状态代码	0																	
零点位置	2146																	
目标位置(lu)	2146																	
目标速度(lu)	0																	
斜坡位置(lu)	-2146																	
斜坡速度(lu/s)	0																	
当前位置(观测值)(lu)	0																	
当前速度(观测值)(lu/s)	-38																	
位置误差(lu)	0																	
速度误差(lu/s)	0																	

输出报文	值	位																
2 目标位置(lu)	0																	
目标速度(lu/s)	0																	
运动模式	0																	
控制1	6	<table border="0"> <tr> <td>15</td><td>8</td><td>7</td><td>0</td> </tr> <tr> <td>□□□□□□□□</td><td>□□□□□□□□</td><td>□□□□□□□□</td><td>□□□□□□□□</td> </tr> <tr> <td>31</td><td>24</td><td>23</td><td>16</td> </tr> <tr> <td>□□□□□□□□</td><td>□□□□□□□□</td><td>□□□□□□□□</td><td>□□□□□□□□</td> </tr> </table>	15	8	7	0	□□□□□□□□	□□□□□□□□	□□□□□□□□	□□□□□□□□	31	24	23	16	□□□□□□□□	□□□□□□□□	□□□□□□□□	□□□□□□□□
15	8	7	0															
□□□□□□□□	□□□□□□□□	□□□□□□□□	□□□□□□□□															
31	24	23	16															
□□□□□□□□	□□□□□□□□	□□□□□□□□	□□□□□□□□															
控制2	0	<table border="0"> <tr> <td>15</td><td>8</td><td>7</td><td>0</td> </tr> <tr> <td>□□□□□□□□</td><td>□□□□□□□□</td><td>□□□□□□□□</td><td>□□□□□□□□</td> </tr> <tr> <td>31</td><td>24</td><td>23</td><td>16</td> </tr> <tr> <td>□□□□□□□□</td><td>□□□□□□□□</td><td>□□□□□□□□</td><td>□□□□□□□□</td> </tr> </table>	15	8	7	0	□□□□□□□□	□□□□□□□□	□□□□□□□□	□□□□□□□□	31	24	23	16	□□□□□□□□	□□□□□□□□	□□□□□□□□	□□□□□□□□
15	8	7	0															
□□□□□□□□	□□□□□□□□	□□□□□□□□	□□□□□□□□															
31	24	23	16															
□□□□□□□□	□□□□□□□□	□□□□□□□□	□□□□□□□□															

5.2.5.3.3 波形录制

- 1、 **波形显示区**：用于显示录制的波形。
- 2、 **波形操作区**：用于操作波形录制，包含录制时长、波形显示/隐藏、波形偏移、导出波形、系列显示、系列缩放、系列偏移。
- 3、 **数据显示区**：用于显示光标所在的系列数据。

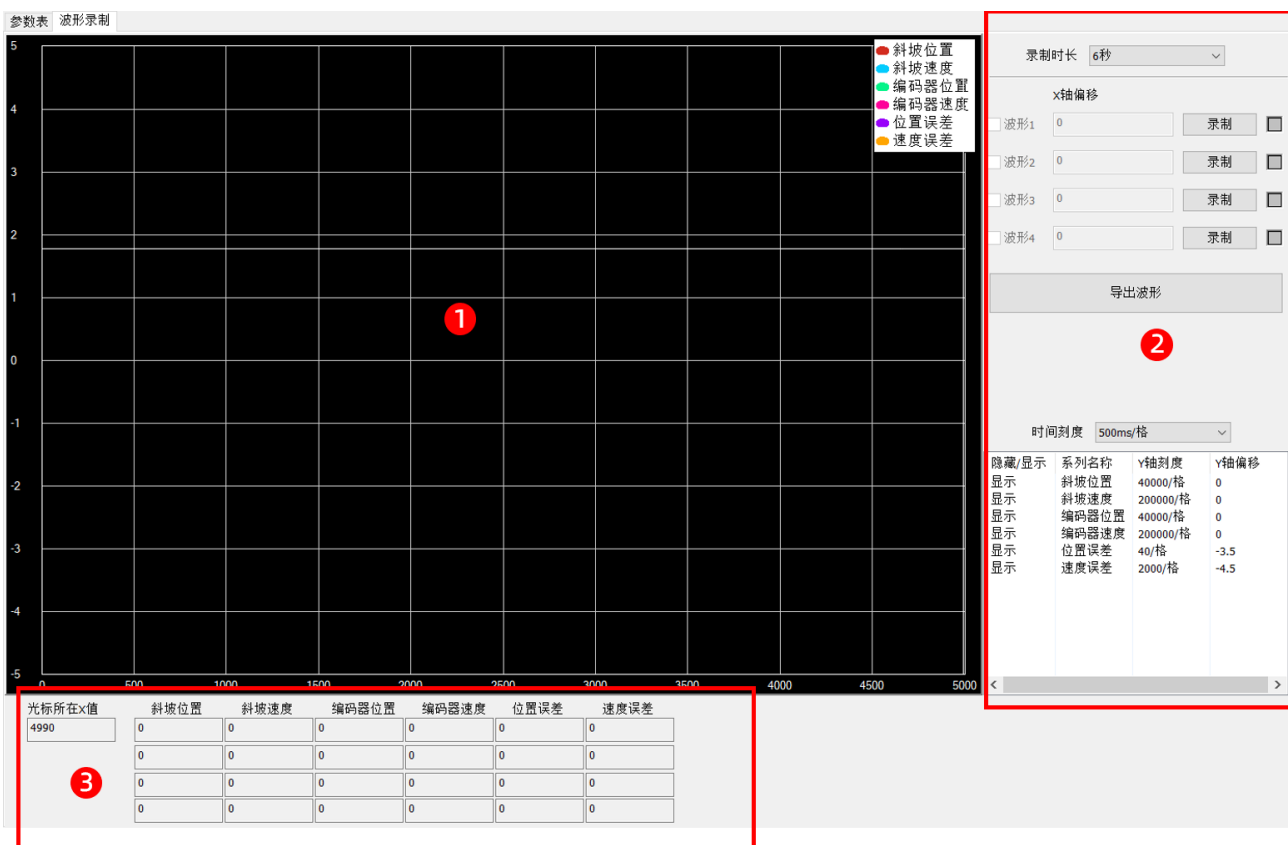

5.2.5.3.3.1 波形显示区

1、 **图例**：用于显示每个系列的颜色。

一组波形中包含 6 条系列，它们分别是：

- (1) 斜坡位置
- (2) 斜坡速度
- (3) 编码器位置
- (4) 编码器速度
- (5) 位置误差
- (6) 速度误差

2、 **光标**：用于定位鼠标所在位置。

注：长按鼠标左键并拖动可调整显示区 X 轴显示范围，鼠标滚轮可将波形图像放大或者缩小。

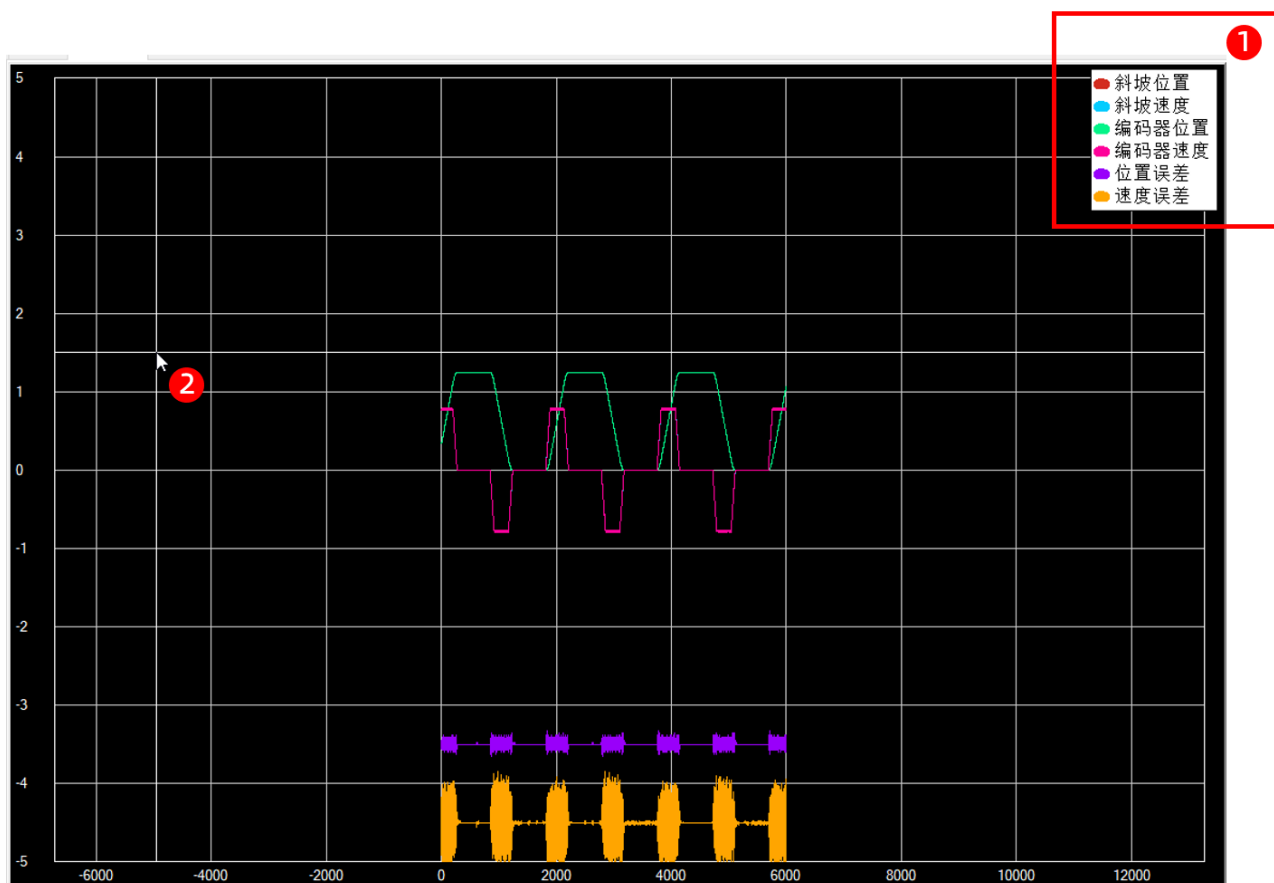

5.2.5.3.3.2 波形操作区

- 1、 **录制时长**: 用于选择录制的时长。可选: 1 秒、2 秒、4 秒、6 秒、8 秒、10 秒、15 秒、20 秒。
- 2、 **波形显示/隐藏**: 用于使对应的波形显示/隐藏。
- 3、 **波形 X 偏移**: 用于将波形水平方向(X 轴)偏移。
- 4、 **波形录制**: 用于开始录制波形。
- 5、 **缓冲区状态灯**: 用于指示该波形有无数据, 有数据则亮绿灯。
- 6、 **导出波形**: 用于将波形数据导出。
- 7、 **时间刻度**: 用于调整 X 轴的刻度。鼠标位于波形显示区时, 也可使用鼠标滚轮来调整。
- 8、 **系列调整**: 对系列绘制进行调整(不会改变原数据), 可调整系列的显示、系列 Y 轴缩放、系列 Y 轴偏移。

The screenshot shows a control panel for waveform recording. At the top, there is a dropdown menu for '录制时长' (Recording Duration) set to '6秒' (6 seconds), marked with a red circle 1. Below this is the 'x轴偏移' (X-axis Offset) section, marked with a red circle 2. It contains four rows for '波形1' through '波形4'. Each row has a checkbox, a text input field with '0', a '录制' (Record) button, and a square status indicator, all marked with red circles 3, 4, and 5 respectively. A large '导出波形' (Export Waveform) button is located below this section, marked with a red circle 6. At the bottom, there is a dropdown menu for '时间刻度' (Time Scale) set to '500ms/格' (500ms/div), marked with a red circle 7. Below the dropdown is a table for series adjustment, marked with a red circle 8.

隐藏/显示	系列名称	Y轴刻度	Y轴偏移
显示	斜坡位置	40000/格	0
显示	斜坡速度	200000/格	0
显示	编码器位置	40000/格	0
显示	编码器速度	200000/格	0
显示	位置误差	40/格	-3.5
显示	速度误差	2000/格	-4.5

5.2.5.3.3.3 数据显示区

- 1、 **光标位置**: 用于显示鼠标所在的 X 轴位置。
- 2、 **系列数据**: 用于显示鼠标所在的 X 轴所对应的系列数据。

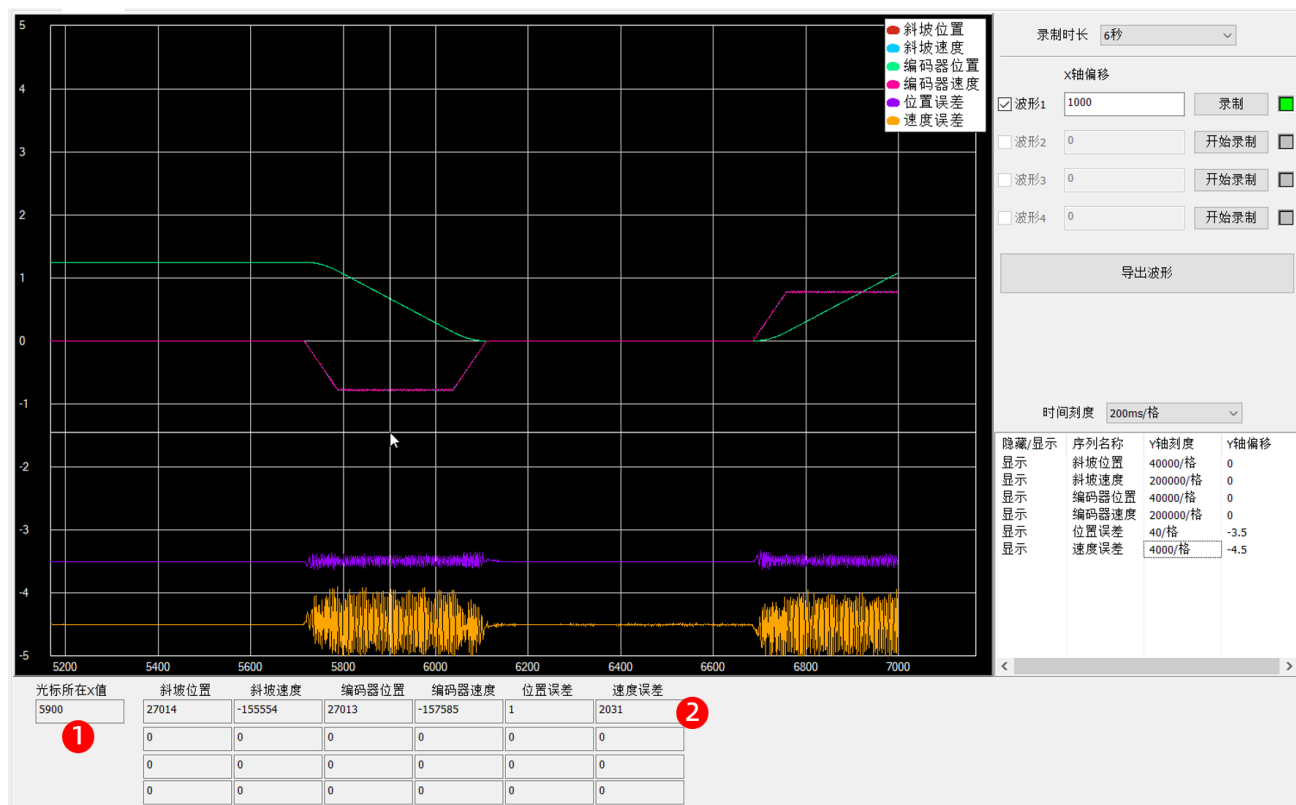

5.2.5.3.4 固件升级

- 1 **上传固件:** 用于点击后选择固件。
- 2 **信息框:** 用于显示设备升级信息。

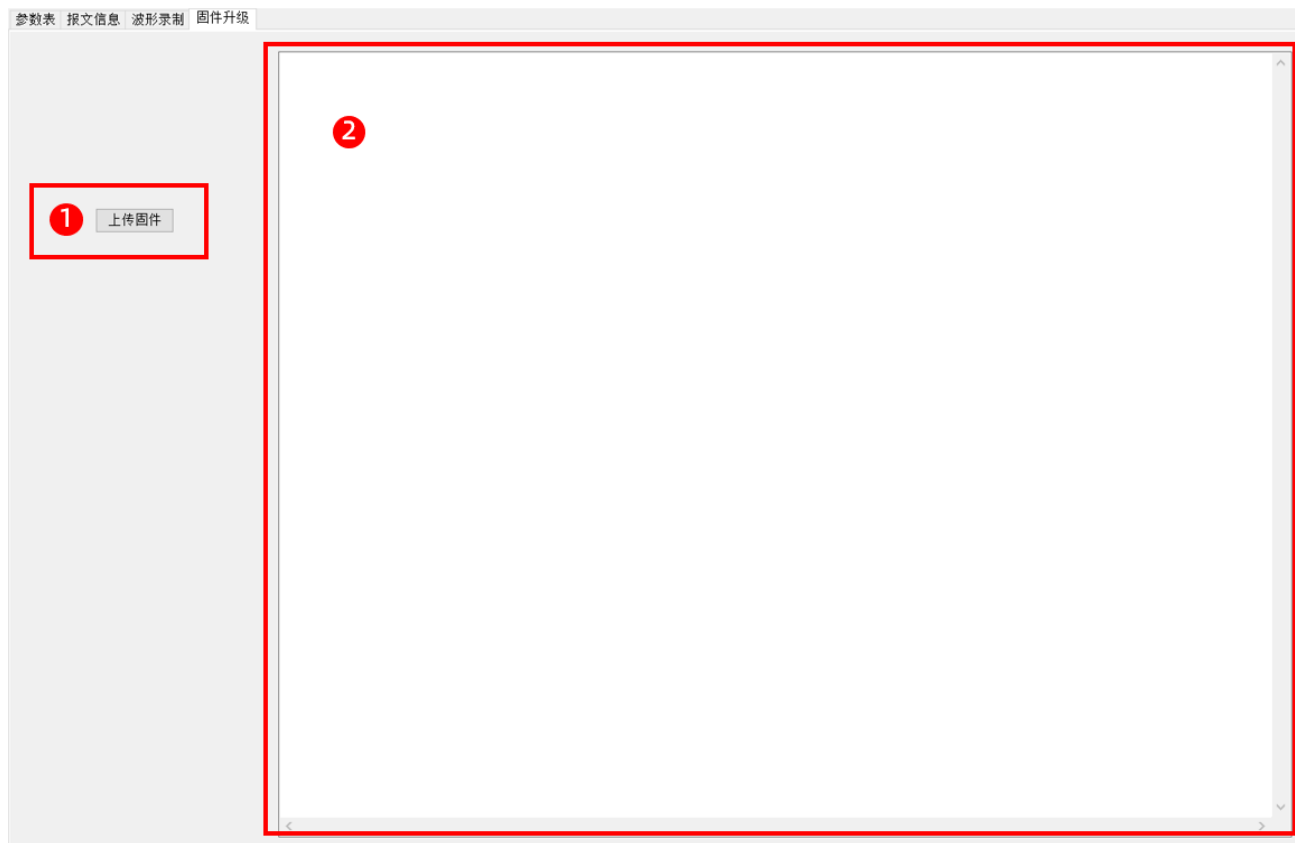

5.2.5.4设备状态一览

用于显示设备的基本信息和通信状况。

- 1、 **设备 MAC**: 显示调试设备的 MAC(物理地址)。
- 2、 **设备 IP**: 显示调试设备的 IP(网络地址)。
- 3、 **设备温度**: 显示调试设备内部的实时温度。
- 4、 **上电次数**: 记录设备的上电次数。
- 5、 **连接状态**: 显示软件与设备的连接状态。
- 6、 **直流母线电压**: 显示直流母线电压, 单位为 VDC。
- 7、 **驱动芯片温度**: 显示驱动芯片温度, 单位为°C。

设备MAC: AA:13:14:00:00:00 1	设备IP: 192.168.0.244 2	设备温度: 35 3	上电次数: 546 4	连接状态: 已连接 5	直流母线电压: 23.48 6	驱动芯片温度: 38 7
--------------------------------------	---------------------------------	----------------------	-----------------------	-----------------------	---------------------------	------------------------

5.3 使用软件调试

5.3.1 调试前准备

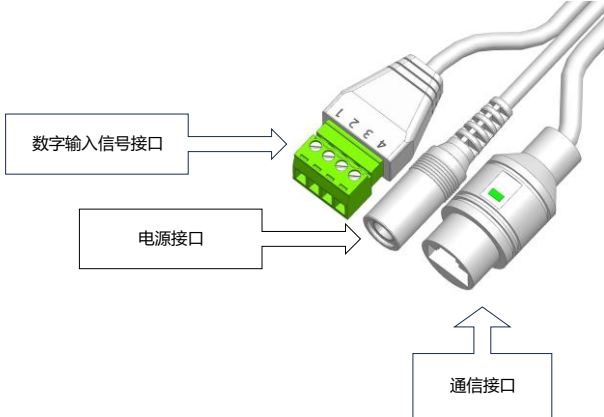
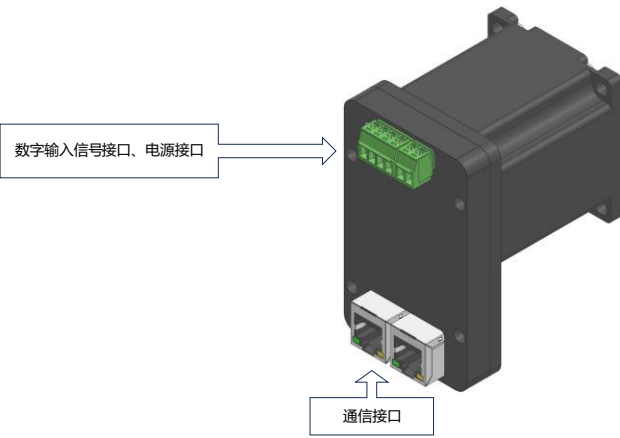
调试前准备		
步骤	作用	图示
1、关闭 DC24V 电源输出。	避免带电操作。	-
2、连接电源电缆。	建立电源连接。	<p>MD42 系列</p>  <p>MD57 系列</p> 
3、连接通信电缆。	建立网络连接。	
4、连接数字输入信号电缆。(非必要)	建设备限位、急停连接。	
5、打开 DC24V 电源输出。	启动设备电源，使其进入工作状态。	

5.3.2 查找调试设备

在调试软件的主窗口中，您可以使用 LED 闪烁勾选框来验证当前选定的设备是否正是您计划修改参数或调试的目标设备。

查找所需调试的设备														
步骤	作用	图示												
1、选择对应网卡	选取和目标设备处于同一局域网的网络适配器。													
2、搜索设备	向所选的网络适配器发送搜索广播。													
3、选择设备	指定目标对象。													
4、勾选 LED 闪烁	使指定设备的系统状态指示灯反映出正在寻找设备的状态。													
5、查看设备	确保选择的操作对象符合预期。	<table border="1"> <thead> <tr> <th>LED灯</th> <th>状态</th> <th>LED闪烁波形(单位:ms)</th> </tr> </thead> <tbody> <tr> <td rowspan="4">STATE</td> <td>1、常亮。控制器已连接通信正常</td> <td></td> </tr> <tr> <td>2、间隔短闪。无控制器连接</td> <td></td> </tr> <tr> <td>3、快闪。设备初始化</td> <td></td> </tr> <tr> <td>4、周期闪烁三次后恢复1/2/3状态。查找设备功能</td> <td></td> </tr> </tbody> </table>	LED灯	状态	LED闪烁波形(单位:ms)	STATE	1、常亮。控制器已连接通信正常		2、间隔短闪。无控制器连接		3、快闪。设备初始化		4、周期闪烁三次后恢复1/2/3状态。查找设备功能	
LED灯	状态	LED闪烁波形(单位:ms)												
STATE	1、常亮。控制器已连接通信正常													
	2、间隔短闪。无控制器连接													
	3、快闪。设备初始化													
	4、周期闪烁三次后恢复1/2/3状态。查找设备功能													

5.3.3 测试数字输入信号

在软件的调试窗口中，您可以实时查看已接入的数字输入信号的数值。

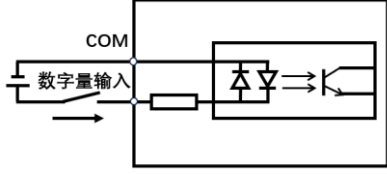
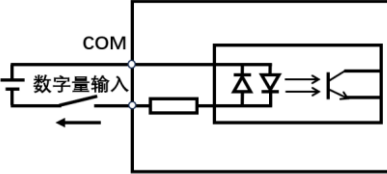
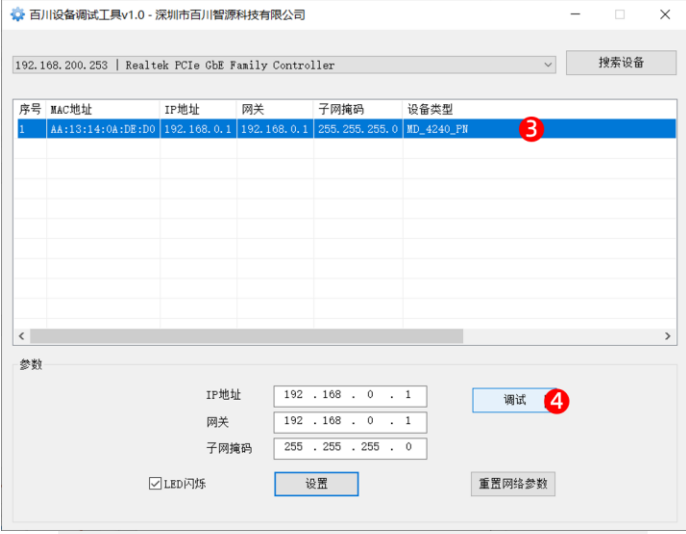
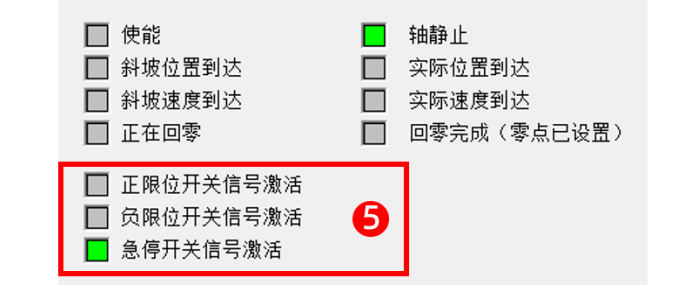
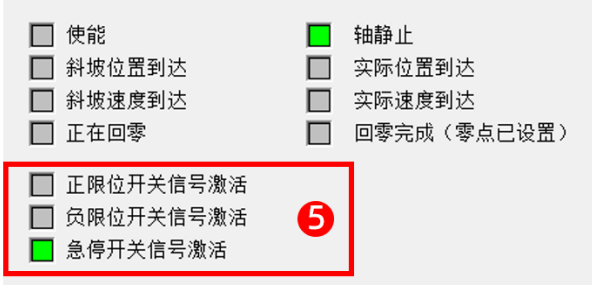
测试数字输入信号		
步骤	作用	图示
1、接入数字输入	使设备能够接收来自外部源的限位和紧急停止信号。	 <p>PNP接线</p>
2、触发外置输入	便于检查信号是否成功接入设备。	 <p>NPN接线</p>
3、选择设备	指定目标对象。	
4、点击调试按钮	打开调试窗口。	
5、查看信号	检查信号是否成功接入设备。	

5.3.4 试运行

5.3.4.1 相对位置模式

相对位置模式		
步骤	作用	图示
1、选择"相对位置模式"。	使设备运动模式切换到相对位置模式并使能。	
2、暂停任务按钮设置为绿灯状态。	让设备不暂停任务。	
3、取消任务设按钮设置为绿灯状态。	让设备不取消任务。	
4、设置设定位置与设定速度。	确定相对位置移动的距离和速度。 以 5000 lu/s 的速度，移动到 10000lu 的位置。	
5、按下启动任务按钮。	设备按照设定的位置和速度执行相对位置运动。	

5.3.4.2 绝对位置模式

绝对位置模式		
步骤	作用	图示
1、确认轴已回零。	绝对位置模式需要零点作为的参考点。	<p>The screenshot shows the control interface for Absolute Position Mode. It includes fields for '运动模式' (Motion Mode) set to '绝对位置模式', '设定位置' (Set Position) at 10000, and '设定速度' (Set Speed) at 5000. There are '设置' (Set) buttons for both. Status indicators include '当前位置' (Current Position) at 0, '当前速度' (Current Speed) at -52, '当前负载' (Current Load) at 1, and '跟随误差' (Tracking Error) at 0. Control buttons include 'Jog+', 'Jog-', '启动任务' (Start Task), '暂停任务' (Pause Task), '取消任务' (Cancel Task), and '确认错误' (Confirm Error). A legend at the bottom shows status indicators for '使能' (Enabled), '轴静止' (Axis Stop), '斜坡位置到达' (Ramp Position Reached), '实际位置到达' (Actual Position Reached), '斜坡速度到达' (Ramp Speed Reached), '实际速度到达' (Actual Speed Reached), '正在回零' (Returning to Zero), and '回零完成 (零点已设置)' (Zeroing Complete (Zero Point Set)).</p>
2、运动模式选择绝对位置模式。	使设备运动模式切换到绝对位置模式并使其能。	
3、暂停任务按钮设置为绿灯状态。	让设备不暂停任务。	
4、取消任务设按钮设置为绿灯状态。	让设备不取消任务。	
5、设置设定位置与设定速度。	确定绝对位置移动的位置和速度。 以 5000 lu/s 的速度向正方向移动 10000 lu。	
6、启动任务按钮。	设备按照设定的位置和速度执行绝对位置运动。	

5.3.4.3速度模式

速度模式		
步骤	作用	图示
1、切换运动模式至速度模式。	将设备运动模式切换到速度的模式并使能。	
2、暂停任务按钮设置为绿灯状态。	让设备不暂停任务。	
3、取消任务设按钮设置为绿灯状态。	让设备不取消任务。	
4、设置设定速度。	确定速度模式移动的速度。 以 5000 lu/s 的速度正转。	
5、启动任务按钮。	设备按照设定的速度执行速度模式运动。	

5.3.4.4 主动回零模式

5.3.4.4.1 扭矩回零

主动回零模式-扭矩回零																																																																																																																																																																																																																																																																																																																																																																																																																																						
步骤	作用	图示																																																																																																																																																																																																																																																																																																																																																																																																																																				
1、参数 limit_protect_en able = 0	关闭硬限位功能。	<p>参数表 波形录制</p> <table border="1"> <thead> <tr> <th>参数号P</th> <th>参数组</th> <th>参数名</th> <th>描述</th> <th>设置值</th> <th>当前值</th> <th>出厂值</th> <th>最小值</th> <th>最大值</th> <th>单</th> </tr> </thead> <tbody> <tr><td>62</td><td>信号参数</td><td>target_reached_threshold</td><td>位置到达阈值</td><td>-10</td><td>-10</td><td>-10</td><td>-16</td><td>16</td><td>2^</td></tr> <tr><td>64</td><td>信号参数</td><td>target_reached_time</td><td>位置到达驻留时间</td><td>10</td><td>10</td><td>10</td><td>1</td><td>65535</td><td>ms</td></tr> <tr><td>66</td><td>信号参数</td><td>velocity_reached_threshold</td><td>速度到达阈值</td><td>10</td><td>10</td><td>10</td><td>1</td><td>6000</td><td>rpr</td></tr> <tr><td>68</td><td>信号参数</td><td>velocity_reached_time</td><td>速度到达驻留时间</td><td>10</td><td>10</td><td>10</td><td>1</td><td>65535</td><td>ms</td></tr> <tr><td>70</td><td>信号参数</td><td>standstill_threshold</td><td>零速阈值</td><td>2</td><td>2</td><td>2</td><td>1</td><td>6000</td><td>rpr</td></tr> <tr><td>72</td><td>信号参数</td><td>standstill_time</td><td>零速驻留时间</td><td>10</td><td>10</td><td>10</td><td>1</td><td>65535</td><td>ms</td></tr> <tr><td>74</td><td>保护功能参数</td><td>following_error_monitoring_enable</td><td>跟随误差监视使能</td><td>0=关闭</td><td>0=关闭</td><td>1</td><td>0</td><td>1</td><td></td></tr> <tr><td>76</td><td>保护功能参数</td><td>following_error_threshold1</td><td>跟随误差阈值1</td><td>-6</td><td>-6</td><td>-6</td><td>-16</td><td>16</td><td>2^</td></tr> <tr><td>78</td><td>保护功能参数</td><td>following_error_threshold2</td><td>跟随误差阈值2</td><td>-2</td><td>-2</td><td>-2</td><td>-16</td><td>16</td><td>2^</td></tr> <tr><td>80</td><td>保护功能参数</td><td>following_error_time</td><td>跟随误差过大驻留时间</td><td>200</td><td>200</td><td>200</td><td>1</td><td>65535</td><td>ms</td></tr> <tr><td>82</td><td>保护功能参数</td><td>stall_protect_enable</td><td>堵转保护使能</td><td>0=关闭</td><td>0=关闭</td><td>0</td><td>0</td><td>1</td><td></td></tr> <tr><td>84</td><td>保护功能参数</td><td>stall_protect_velocity_threshold</td><td>堵转保护速度阈值</td><td>2</td><td>2</td><td>2</td><td>1</td><td>6000</td><td>rpr</td></tr> <tr><td>86</td><td>保护功能参数</td><td>stall_protect_torque_threshold</td><td>堵转保护转矩阈值</td><td>98</td><td>98</td><td>98</td><td>1</td><td>100</td><td>%</td></tr> <tr><td>88</td><td>保护功能参数</td><td>stall_protect_time</td><td>堵转保护时间</td><td>200</td><td>200</td><td>200</td><td>1</td><td>65535</td><td>ms</td></tr> <tr><td>90</td><td>保护功能参数</td><td>limit_protect_enable</td><td>硬限位保护使能</td><td>0=关闭</td><td>0=关闭</td><td>1</td><td>0</td><td>1</td><td></td></tr> <tr><td>92</td><td>保护功能参数</td><td>limit_switch_positive</td><td>硬限位信号极性</td><td>0=常开型信号</td><td>0=常开型信号</td><td>1</td><td>0</td><td>1</td><td></td></tr> <tr><td>94</td><td>保护功能参数</td><td>limit_switch_swap</td><td>硬限位信号交换</td><td>0=关闭</td><td>0=关闭</td><td>0</td><td>0</td><td>1</td><td></td></tr> <tr><td>96</td><td>保护功能参数</td><td>soft_limit_protect_enable</td><td>软限位保护使能</td><td>0=关闭</td><td>0=关闭</td><td>0</td><td>0</td><td>1</td><td></td></tr> <tr><td>98</td><td>保护功能参数</td><td>soft_positive_limit</td><td>软正限位</td><td>0</td><td>0</td><td>0</td><td>-2147483647</td><td>2147483647</td><td>lu</td></tr> <tr><td>100</td><td>保护功能参数</td><td>soft_negative_limit</td><td>软负限位</td><td>0</td><td>0</td><td>0</td><td>-2147483647</td><td>2147483647</td><td>lu</td></tr> <tr><td>102</td><td>保护功能参数</td><td>emergency_stop_enable</td><td>急停功能使能</td><td>0=关闭</td><td>0=关闭</td><td>0</td><td>0</td><td>1</td><td></td></tr> <tr><td>104</td><td></td><td></td><td></td><td></td><td></td><td></td><td></td><td></td><td></td></tr> <tr><td>106</td><td>回零参数</td><td>homing_method</td><td>零点搜索方法</td><td>0=扭矩回零</td><td>0=扭矩回零</td><td>0</td><td>0</td><td>1</td><td></td></tr> <tr><td>108</td><td>回零参数</td><td>homing_dir</td><td>零点搜索方向</td><td>0=逆时针方向</td><td>0=逆时针方向</td><td>0</td><td>0</td><td>1</td><td></td></tr> <tr><td>110</td><td>回零参数</td><td>homing_use_z_signal</td><td>z信号辅助回零</td><td>0=关闭</td><td>0=关闭</td><td>1</td><td>0</td><td>1</td><td></td></tr> <tr><td>112</td><td>回零参数</td><td>homing_velocity1</td><td>零点搜索速度1</td><td>60</td><td>60</td><td>60</td><td>1</td><td>6000</td><td>rpr</td></tr> <tr><td>114</td><td>回零参数</td><td>homing_velocity2</td><td>零点搜索速度2</td><td>10</td><td>10</td><td>10</td><td>1</td><td>6000</td><td>rpr</td></tr> <tr><td>116</td><td>回零参数</td><td>homing_torque_threshold</td><td>扭矩回零阈值</td><td>98</td><td>98</td><td>98</td><td>1</td><td>100</td><td>%</td></tr> <tr><td>118</td><td>回零参数</td><td>homing_torque_time</td><td>扭矩回零到达驻留时间</td><td>10</td><td>10</td><td>10</td><td>1</td><td>65535</td><td>ms</td></tr> <tr><td>120</td><td>回零参数</td><td>home_offset</td><td>零点搜索完成后偏移距离</td><td>0</td><td>0</td><td>0</td><td>-2147483647</td><td>2147483647</td><td>lu</td></tr> <tr><td>122</td><td></td><td></td><td></td><td></td><td></td><td></td><td></td><td></td><td></td></tr> <tr><td>124</td><td></td><td></td><td></td><td></td><td></td><td></td><td></td><td></td><td></td></tr> <tr><td>126</td><td></td><td></td><td></td><td></td><td></td><td></td><td></td><td></td><td></td></tr> <tr><td>128</td><td></td><td></td><td></td><td></td><td></td><td></td><td></td><td></td><td></td></tr> <tr><td>130</td><td>点动参数</td><td>jog_velocity</td><td>JOG点动速度</td><td>60</td><td>60</td><td>60</td><td>1</td><td>6000</td><td>rpr</td></tr> <tr><td>132</td><td>点动参数</td><td>jog_increase_distance</td><td>JOG寸动距离</td><td>-2</td><td>-2</td><td>-2</td><td>-16</td><td>16</td><td>2^</td></tr> <tr><td>134</td><td>程序块参数</td><td>program_block_operation_mode</td><td>程序块运行模式</td><td>1=循环运行模式</td><td>1=循环运行模式</td><td>0</td><td>0</td><td>1</td><td></td></tr> <tr><td>136</td><td>程序块参数</td><td>program_block_start_step</td><td>程序块起始步</td><td>1</td><td>1</td><td>1</td><td>1</td><td>16</td><td></td></tr> <tr><td>138</td><td>程序块参数</td><td>program_block_end_step</td><td>程序块结束步</td><td>2</td><td>2</td><td>1</td><td>1</td><td>16</td><td></td></tr> <tr><td>140</td><td>程序块</td><td>program_block_step[1].Xtarget</td><td>程序步[1]目标位置</td><td>0</td><td>0</td><td>0</td><td>-2147483647</td><td>2147483647</td><td>lu</td></tr> <tr><td>142</td><td>程序块</td><td>program_block_step[1].Vtarget</td><td>程序步[1]目标速度</td><td>5000</td><td>5000</td><td>1</td><td>1</td><td>2147483647</td><td>lu/</td></tr> </tbody> </table>	参数号P	参数组	参数名	描述	设置值	当前值	出厂值	最小值	最大值	单	62	信号参数	target_reached_threshold	位置到达阈值	-10	-10	-10	-16	16	2^	64	信号参数	target_reached_time	位置到达驻留时间	10	10	10	1	65535	ms	66	信号参数	velocity_reached_threshold	速度到达阈值	10	10	10	1	6000	rpr	68	信号参数	velocity_reached_time	速度到达驻留时间	10	10	10	1	65535	ms	70	信号参数	standstill_threshold	零速阈值	2	2	2	1	6000	rpr	72	信号参数	standstill_time	零速驻留时间	10	10	10	1	65535	ms	74	保护功能参数	following_error_monitoring_enable	跟随误差监视使能	0=关闭	0=关闭	1	0	1		76	保护功能参数	following_error_threshold1	跟随误差阈值1	-6	-6	-6	-16	16	2^	78	保护功能参数	following_error_threshold2	跟随误差阈值2	-2	-2	-2	-16	16	2^	80	保护功能参数	following_error_time	跟随误差过大驻留时间	200	200	200	1	65535	ms	82	保护功能参数	stall_protect_enable	堵转保护使能	0=关闭	0=关闭	0	0	1		84	保护功能参数	stall_protect_velocity_threshold	堵转保护速度阈值	2	2	2	1	6000	rpr	86	保护功能参数	stall_protect_torque_threshold	堵转保护转矩阈值	98	98	98	1	100	%	88	保护功能参数	stall_protect_time	堵转保护时间	200	200	200	1	65535	ms	90	保护功能参数	limit_protect_enable	硬限位保护使能	0=关闭	0=关闭	1	0	1		92	保护功能参数	limit_switch_positive	硬限位信号极性	0=常开型信号	0=常开型信号	1	0	1		94	保护功能参数	limit_switch_swap	硬限位信号交换	0=关闭	0=关闭	0	0	1		96	保护功能参数	soft_limit_protect_enable	软限位保护使能	0=关闭	0=关闭	0	0	1		98	保护功能参数	soft_positive_limit	软正限位	0	0	0	-2147483647	2147483647	lu	100	保护功能参数	soft_negative_limit	软负限位	0	0	0	-2147483647	2147483647	lu	102	保护功能参数	emergency_stop_enable	急停功能使能	0=关闭	0=关闭	0	0	1		104										106	回零参数	homing_method	零点搜索方法	0=扭矩回零	0=扭矩回零	0	0	1		108	回零参数	homing_dir	零点搜索方向	0=逆时针方向	0=逆时针方向	0	0	1		110	回零参数	homing_use_z_signal	z信号辅助回零	0=关闭	0=关闭	1	0	1		112	回零参数	homing_velocity1	零点搜索速度1	60	60	60	1	6000	rpr	114	回零参数	homing_velocity2	零点搜索速度2	10	10	10	1	6000	rpr	116	回零参数	homing_torque_threshold	扭矩回零阈值	98	98	98	1	100	%	118	回零参数	homing_torque_time	扭矩回零到达驻留时间	10	10	10	1	65535	ms	120	回零参数	home_offset	零点搜索完成后偏移距离	0	0	0	-2147483647	2147483647	lu	122										124										126										128										130	点动参数	jog_velocity	JOG点动速度	60	60	60	1	6000	rpr	132	点动参数	jog_increase_distance	JOG寸动距离	-2	-2	-2	-16	16	2^	134	程序块参数	program_block_operation_mode	程序块运行模式	1=循环运行模式	1=循环运行模式	0	0	1		136	程序块参数	program_block_start_step	程序块起始步	1	1	1	1	16		138	程序块参数	program_block_end_step	程序块结束步	2	2	1	1	16		140	程序块	program_block_step[1].Xtarget	程序步[1]目标位置	0	0	0	-2147483647	2147483647	lu	142	程序块	program_block_step[1].Vtarget	程序步[1]目标速度	5000	5000	1	1	2147483647	lu/
参数号P	参数组	参数名	描述	设置值	当前值	出厂值	最小值	最大值	单																																																																																																																																																																																																																																																																																																																																																																																																																													
62	信号参数	target_reached_threshold	位置到达阈值	-10	-10	-10	-16	16	2^																																																																																																																																																																																																																																																																																																																																																																																																																													
64	信号参数	target_reached_time	位置到达驻留时间	10	10	10	1	65535	ms																																																																																																																																																																																																																																																																																																																																																																																																																													
66	信号参数	velocity_reached_threshold	速度到达阈值	10	10	10	1	6000	rpr																																																																																																																																																																																																																																																																																																																																																																																																																													
68	信号参数	velocity_reached_time	速度到达驻留时间	10	10	10	1	65535	ms																																																																																																																																																																																																																																																																																																																																																																																																																													
70	信号参数	standstill_threshold	零速阈值	2	2	2	1	6000	rpr																																																																																																																																																																																																																																																																																																																																																																																																																													
72	信号参数	standstill_time	零速驻留时间	10	10	10	1	65535	ms																																																																																																																																																																																																																																																																																																																																																																																																																													
74	保护功能参数	following_error_monitoring_enable	跟随误差监视使能	0=关闭	0=关闭	1	0	1																																																																																																																																																																																																																																																																																																																																																																																																																														
76	保护功能参数	following_error_threshold1	跟随误差阈值1	-6	-6	-6	-16	16	2^																																																																																																																																																																																																																																																																																																																																																																																																																													
78	保护功能参数	following_error_threshold2	跟随误差阈值2	-2	-2	-2	-16	16	2^																																																																																																																																																																																																																																																																																																																																																																																																																													
80	保护功能参数	following_error_time	跟随误差过大驻留时间	200	200	200	1	65535	ms																																																																																																																																																																																																																																																																																																																																																																																																																													
82	保护功能参数	stall_protect_enable	堵转保护使能	0=关闭	0=关闭	0	0	1																																																																																																																																																																																																																																																																																																																																																																																																																														
84	保护功能参数	stall_protect_velocity_threshold	堵转保护速度阈值	2	2	2	1	6000	rpr																																																																																																																																																																																																																																																																																																																																																																																																																													
86	保护功能参数	stall_protect_torque_threshold	堵转保护转矩阈值	98	98	98	1	100	%																																																																																																																																																																																																																																																																																																																																																																																																																													
88	保护功能参数	stall_protect_time	堵转保护时间	200	200	200	1	65535	ms																																																																																																																																																																																																																																																																																																																																																																																																																													
90	保护功能参数	limit_protect_enable	硬限位保护使能	0=关闭	0=关闭	1	0	1																																																																																																																																																																																																																																																																																																																																																																																																																														
92	保护功能参数	limit_switch_positive	硬限位信号极性	0=常开型信号	0=常开型信号	1	0	1																																																																																																																																																																																																																																																																																																																																																																																																																														
94	保护功能参数	limit_switch_swap	硬限位信号交换	0=关闭	0=关闭	0	0	1																																																																																																																																																																																																																																																																																																																																																																																																																														
96	保护功能参数	soft_limit_protect_enable	软限位保护使能	0=关闭	0=关闭	0	0	1																																																																																																																																																																																																																																																																																																																																																																																																																														
98	保护功能参数	soft_positive_limit	软正限位	0	0	0	-2147483647	2147483647	lu																																																																																																																																																																																																																																																																																																																																																																																																																													
100	保护功能参数	soft_negative_limit	软负限位	0	0	0	-2147483647	2147483647	lu																																																																																																																																																																																																																																																																																																																																																																																																																													
102	保护功能参数	emergency_stop_enable	急停功能使能	0=关闭	0=关闭	0	0	1																																																																																																																																																																																																																																																																																																																																																																																																																														
104																																																																																																																																																																																																																																																																																																																																																																																																																																						
106	回零参数	homing_method	零点搜索方法	0=扭矩回零	0=扭矩回零	0	0	1																																																																																																																																																																																																																																																																																																																																																																																																																														
108	回零参数	homing_dir	零点搜索方向	0=逆时针方向	0=逆时针方向	0	0	1																																																																																																																																																																																																																																																																																																																																																																																																																														
110	回零参数	homing_use_z_signal	z信号辅助回零	0=关闭	0=关闭	1	0	1																																																																																																																																																																																																																																																																																																																																																																																																																														
112	回零参数	homing_velocity1	零点搜索速度1	60	60	60	1	6000	rpr																																																																																																																																																																																																																																																																																																																																																																																																																													
114	回零参数	homing_velocity2	零点搜索速度2	10	10	10	1	6000	rpr																																																																																																																																																																																																																																																																																																																																																																																																																													
116	回零参数	homing_torque_threshold	扭矩回零阈值	98	98	98	1	100	%																																																																																																																																																																																																																																																																																																																																																																																																																													
118	回零参数	homing_torque_time	扭矩回零到达驻留时间	10	10	10	1	65535	ms																																																																																																																																																																																																																																																																																																																																																																																																																													
120	回零参数	home_offset	零点搜索完成后偏移距离	0	0	0	-2147483647	2147483647	lu																																																																																																																																																																																																																																																																																																																																																																																																																													
122																																																																																																																																																																																																																																																																																																																																																																																																																																						
124																																																																																																																																																																																																																																																																																																																																																																																																																																						
126																																																																																																																																																																																																																																																																																																																																																																																																																																						
128																																																																																																																																																																																																																																																																																																																																																																																																																																						
130	点动参数	jog_velocity	JOG点动速度	60	60	60	1	6000	rpr																																																																																																																																																																																																																																																																																																																																																																																																																													
132	点动参数	jog_increase_distance	JOG寸动距离	-2	-2	-2	-16	16	2^																																																																																																																																																																																																																																																																																																																																																																																																																													
134	程序块参数	program_block_operation_mode	程序块运行模式	1=循环运行模式	1=循环运行模式	0	0	1																																																																																																																																																																																																																																																																																																																																																																																																																														
136	程序块参数	program_block_start_step	程序块起始步	1	1	1	1	16																																																																																																																																																																																																																																																																																																																																																																																																																														
138	程序块参数	program_block_end_step	程序块结束步	2	2	1	1	16																																																																																																																																																																																																																																																																																																																																																																																																																														
140	程序块	program_block_step[1].Xtarget	程序步[1]目标位置	0	0	0	-2147483647	2147483647	lu																																																																																																																																																																																																																																																																																																																																																																																																																													
142	程序块	program_block_step[1].Vtarget	程序步[1]目标速度	5000	5000	1	1	2147483647	lu/																																																																																																																																																																																																																																																																																																																																																																																																																													
2、参数 homing_metho d = 0	使用扭矩回零。																																																																																																																																																																																																																																																																																																																																																																																																																																					
3、参数 homing_use_z_ signal = 0	关闭 z 信号辅助回零。																																																																																																																																																																																																																																																																																																																																																																																																																																					
4、参数 homing_torque _threshold = 98	扭矩回零阈值设置为 98%。																																																																																																																																																																																																																																																																																																																																																																																																																																					
5、切换运动模式 至主动回零模 式。	将设备运动模式切换到主动回零模式并使能。	<p>运动模式 主动回零模式</p>																																																																																																																																																																																																																																																																																																																																																																																																																																				
6、暂停任务按钮 设置为绿灯状 态。	让设备不暂停任务。	<p>暂停任务</p>																																																																																																																																																																																																																																																																																																																																																																																																																																				
7、取消任务设按 钮设置为绿灯状 态。	让设备不取消任务。	<p>取消任务</p>																																																																																																																																																																																																																																																																																																																																																																																																																																				
8、启动任务按 钮。	设备按照参数表设定的回零参数进行主动回零运动。	<p>启动任务</p>																																																																																																																																																																																																																																																																																																																																																																																																																																				

5.3.4.4.2 扭矩回零+编码器 z 信号

主动回零模式-扭矩回零+编码器 z 信号																																																																																																																																																																																																																																																																																																																																																																																																																																						
步骤	作用	图示																																																																																																																																																																																																																																																																																																																																																																																																																																				
1、参数 limit_protect_enable = 0	关闭硬限位功能。	<table border="1"> <thead> <tr> <th>参数号</th> <th>参数组</th> <th>参数名</th> <th>描述</th> <th>设置值</th> <th>当前值</th> <th>出厂值</th> <th>最小值</th> <th>最大值</th> <th>单位</th> </tr> </thead> <tbody> <tr><td>62</td><td>信号参数</td><td>target_reached_threshold</td><td>位置到达阈值</td><td>-10</td><td>-10</td><td>-10</td><td>-16</td><td>16</td><td>2*π</td></tr> <tr><td>64</td><td>信号参数</td><td>target_reached_time</td><td>位置到达驻留时间</td><td>10</td><td>10</td><td>10</td><td>1</td><td>65535</td><td>ms</td></tr> <tr><td>66</td><td>信号参数</td><td>velocity_reached_threshold</td><td>速度到达阈值</td><td>10</td><td>10</td><td>10</td><td>1</td><td>6000</td><td>rpm</td></tr> <tr><td>68</td><td>信号参数</td><td>velocity_reached_time</td><td>速度到达驻留时间</td><td>10</td><td>10</td><td>10</td><td>1</td><td>65535</td><td>ms</td></tr> <tr><td>70</td><td>信号参数</td><td>standstill_threshold</td><td>零速阈值</td><td>2</td><td>2</td><td>2</td><td>1</td><td>6000</td><td>rpm</td></tr> <tr><td>72</td><td>信号参数</td><td>standstill_time</td><td>零速驻留时间</td><td>10</td><td>10</td><td>10</td><td>1</td><td>65535</td><td>ms</td></tr> <tr><td>74</td><td>保护功能参数</td><td>following_error_monitoring_enable</td><td>跟随误差监视使能</td><td>0=关闭</td><td>0=关闭</td><td>1</td><td>0</td><td>1</td><td></td></tr> <tr><td>76</td><td>保护功能参数</td><td>following_error_threshold1</td><td>跟随误差阈值1</td><td>-6</td><td>-6</td><td>-6</td><td>-16</td><td>16</td><td>2*π</td></tr> <tr><td>78</td><td>保护功能参数</td><td>following_error_threshold2</td><td>跟随误差阈值2</td><td>-2</td><td>-2</td><td>-2</td><td>-16</td><td>16</td><td>2*π</td></tr> <tr><td>80</td><td>保护功能参数</td><td>following_error_time</td><td>跟随误差过大驻留时间</td><td>200</td><td>200</td><td>200</td><td>1</td><td>65535</td><td>ms</td></tr> <tr><td>82</td><td>保护功能参数</td><td>stall_protect_enable</td><td>堵转保护使能</td><td>0=关闭</td><td>0=关闭</td><td>0</td><td>0</td><td>1</td><td></td></tr> <tr><td>84</td><td>保护功能参数</td><td>stall_protect_velocity_threshold</td><td>堵转保护速度阈值</td><td>2</td><td>2</td><td>2</td><td>1</td><td>6000</td><td>rpm</td></tr> <tr><td>86</td><td>保护功能参数</td><td>stall_protect_torque_threshold</td><td>堵转保护转矩阈值</td><td>98</td><td>98</td><td>98</td><td>1</td><td>100</td><td>%</td></tr> <tr><td>88</td><td>保护功能参数</td><td>stall_protect_time</td><td>堵转保护时间</td><td>200</td><td>200</td><td>200</td><td>1</td><td>65535</td><td>ms</td></tr> <tr><td>90</td><td>保护功能参数</td><td>limit_protect_enable</td><td>硬限位保护使能</td><td>0=关闭</td><td>0=关闭</td><td>0</td><td>0</td><td>1</td><td></td></tr> <tr><td>92</td><td>保护功能参数</td><td>limit_switch_priority</td><td>硬限位信号优先级</td><td>0=高开型信号</td><td>0=高开型信号</td><td>1</td><td>0</td><td>1</td><td></td></tr> <tr><td>94</td><td>保护功能参数</td><td>limit_switch_swap</td><td>硬限位交换</td><td>0=关闭</td><td>0=关闭</td><td>0</td><td>0</td><td>1</td><td></td></tr> <tr><td>96</td><td>保护功能参数</td><td>soft_limit_protect_enable</td><td>软限位保护使能</td><td>0=关闭</td><td>0=关闭</td><td>0</td><td>0</td><td>1</td><td></td></tr> <tr><td>98</td><td>保护功能参数</td><td>soft_positive_limit</td><td>软正限位</td><td>0</td><td>0</td><td>0</td><td>-2147483647</td><td>2147483647</td><td>lu</td></tr> <tr><td>100</td><td>保护功能参数</td><td>soft_negative_limit</td><td>软负限位</td><td>0</td><td>0</td><td>0</td><td>-2147483647</td><td>2147483647</td><td>lu</td></tr> <tr><td>102</td><td>保护功能参数</td><td>emergency_stop_enable</td><td>急停功能使能</td><td>0=关闭</td><td>0=关闭</td><td>0</td><td>0</td><td>1</td><td></td></tr> <tr><td>104</td><td></td><td></td><td></td><td></td><td></td><td></td><td></td><td></td><td></td></tr> <tr><td>106</td><td>回零参数</td><td>homing_method</td><td>零点搜索方法</td><td>0=扭矩回零</td><td>0=扭矩回零</td><td>0</td><td>0</td><td>1</td><td></td></tr> <tr><td>108</td><td>回零参数</td><td>homing_dir</td><td>零点搜索方向</td><td>0=逆时针方向</td><td>0=逆时针方向</td><td>0</td><td>0</td><td>1</td><td></td></tr> <tr><td>110</td><td>回零参数</td><td>homing_use_z_signal</td><td>z信号辅助回零</td><td>1=开启</td><td>1=开启</td><td>1</td><td>0</td><td>1</td><td></td></tr> <tr><td>112</td><td>回零参数</td><td>homing_velocity1</td><td>零点搜索速度1</td><td>60</td><td>60</td><td>60</td><td>1</td><td>6000</td><td>rpm</td></tr> <tr><td>114</td><td>回零参数</td><td>homing_velocity2</td><td>零点搜索速度2</td><td>10</td><td>10</td><td>10</td><td>1</td><td>6000</td><td>rpm</td></tr> <tr><td>116</td><td>回零参数</td><td>homing_torque_threshold</td><td>扭矩回零阈值</td><td>98</td><td>98</td><td>98</td><td>1</td><td>100</td><td>%</td></tr> <tr><td>118</td><td>回零参数</td><td>homing_torque_time</td><td>扭矩阈值到达驻留时间</td><td>10</td><td>10</td><td>10</td><td>1</td><td>65535</td><td>ms</td></tr> <tr><td>120</td><td>回零参数</td><td>home_offset</td><td>零点搜索完成后偏移距离</td><td>0</td><td>0</td><td>0</td><td>-2147483647</td><td>2147483647</td><td>lu</td></tr> <tr><td>122</td><td></td><td></td><td></td><td></td><td></td><td></td><td></td><td></td><td></td></tr> <tr><td>124</td><td></td><td></td><td></td><td></td><td></td><td></td><td></td><td></td><td></td></tr> <tr><td>126</td><td></td><td></td><td></td><td></td><td></td><td></td><td></td><td></td><td></td></tr> <tr><td>128</td><td></td><td></td><td></td><td></td><td></td><td></td><td></td><td></td><td></td></tr> <tr><td>130</td><td>点动参数</td><td>jog_velocity</td><td>JOG点动速度</td><td>60</td><td>60</td><td>60</td><td>1</td><td>6000</td><td>rpm</td></tr> <tr><td>132</td><td>点动参数</td><td>jog_increase_distance</td><td>JOG点动距离</td><td>-2</td><td>-2</td><td>-2</td><td>-16</td><td>16</td><td>2*π</td></tr> <tr><td>134</td><td>程序块参数</td><td>program_block_operation_mode</td><td>程序块运行模式</td><td>1=循环运行模式</td><td>1=循环运行模式</td><td>0</td><td>0</td><td>1</td><td></td></tr> <tr><td>136</td><td>程序块参数</td><td>program_block_start_step</td><td>程序块起始步</td><td>1</td><td>1</td><td>1</td><td>1</td><td>16</td><td></td></tr> <tr><td>138</td><td>程序块参数</td><td>program_block_end_step</td><td>程序块结束步</td><td>2</td><td>2</td><td>1</td><td>1</td><td>16</td><td></td></tr> <tr><td>140</td><td>程序块</td><td>program_block_step[1].Xtarget</td><td>程序步[1]目标位置</td><td>0</td><td>0</td><td>0</td><td>-2147483647</td><td>2147483647</td><td>lu</td></tr> <tr><td>142</td><td>程序块</td><td>program_block_step[1].Vtarget</td><td>程序步[1]目标速度</td><td>5000</td><td>5000</td><td>1</td><td>1</td><td>2147483647</td><td>lu/s</td></tr> </tbody> </table> <p>上传 读取 保存 上传并保存 参数恢复出厂 重启 参数导入</p>	参数号	参数组	参数名	描述	设置值	当前值	出厂值	最小值	最大值	单位	62	信号参数	target_reached_threshold	位置到达阈值	-10	-10	-10	-16	16	2*π	64	信号参数	target_reached_time	位置到达驻留时间	10	10	10	1	65535	ms	66	信号参数	velocity_reached_threshold	速度到达阈值	10	10	10	1	6000	rpm	68	信号参数	velocity_reached_time	速度到达驻留时间	10	10	10	1	65535	ms	70	信号参数	standstill_threshold	零速阈值	2	2	2	1	6000	rpm	72	信号参数	standstill_time	零速驻留时间	10	10	10	1	65535	ms	74	保护功能参数	following_error_monitoring_enable	跟随误差监视使能	0=关闭	0=关闭	1	0	1		76	保护功能参数	following_error_threshold1	跟随误差阈值1	-6	-6	-6	-16	16	2*π	78	保护功能参数	following_error_threshold2	跟随误差阈值2	-2	-2	-2	-16	16	2*π	80	保护功能参数	following_error_time	跟随误差过大驻留时间	200	200	200	1	65535	ms	82	保护功能参数	stall_protect_enable	堵转保护使能	0=关闭	0=关闭	0	0	1		84	保护功能参数	stall_protect_velocity_threshold	堵转保护速度阈值	2	2	2	1	6000	rpm	86	保护功能参数	stall_protect_torque_threshold	堵转保护转矩阈值	98	98	98	1	100	%	88	保护功能参数	stall_protect_time	堵转保护时间	200	200	200	1	65535	ms	90	保护功能参数	limit_protect_enable	硬限位保护使能	0=关闭	0=关闭	0	0	1		92	保护功能参数	limit_switch_priority	硬限位信号优先级	0=高开型信号	0=高开型信号	1	0	1		94	保护功能参数	limit_switch_swap	硬限位交换	0=关闭	0=关闭	0	0	1		96	保护功能参数	soft_limit_protect_enable	软限位保护使能	0=关闭	0=关闭	0	0	1		98	保护功能参数	soft_positive_limit	软正限位	0	0	0	-2147483647	2147483647	lu	100	保护功能参数	soft_negative_limit	软负限位	0	0	0	-2147483647	2147483647	lu	102	保护功能参数	emergency_stop_enable	急停功能使能	0=关闭	0=关闭	0	0	1		104										106	回零参数	homing_method	零点搜索方法	0=扭矩回零	0=扭矩回零	0	0	1		108	回零参数	homing_dir	零点搜索方向	0=逆时针方向	0=逆时针方向	0	0	1		110	回零参数	homing_use_z_signal	z信号辅助回零	1=开启	1=开启	1	0	1		112	回零参数	homing_velocity1	零点搜索速度1	60	60	60	1	6000	rpm	114	回零参数	homing_velocity2	零点搜索速度2	10	10	10	1	6000	rpm	116	回零参数	homing_torque_threshold	扭矩回零阈值	98	98	98	1	100	%	118	回零参数	homing_torque_time	扭矩阈值到达驻留时间	10	10	10	1	65535	ms	120	回零参数	home_offset	零点搜索完成后偏移距离	0	0	0	-2147483647	2147483647	lu	122										124										126										128										130	点动参数	jog_velocity	JOG点动速度	60	60	60	1	6000	rpm	132	点动参数	jog_increase_distance	JOG点动距离	-2	-2	-2	-16	16	2*π	134	程序块参数	program_block_operation_mode	程序块运行模式	1=循环运行模式	1=循环运行模式	0	0	1		136	程序块参数	program_block_start_step	程序块起始步	1	1	1	1	16		138	程序块参数	program_block_end_step	程序块结束步	2	2	1	1	16		140	程序块	program_block_step[1].Xtarget	程序步[1]目标位置	0	0	0	-2147483647	2147483647	lu	142	程序块	program_block_step[1].Vtarget	程序步[1]目标速度	5000	5000	1	1	2147483647	lu/s
参数号	参数组		参数名	描述	设置值	当前值	出厂值	最小值	最大值	单位																																																																																																																																																																																																																																																																																																																																																																																																																												
62	信号参数		target_reached_threshold	位置到达阈值	-10	-10	-10	-16	16	2*π																																																																																																																																																																																																																																																																																																																																																																																																																												
64	信号参数		target_reached_time	位置到达驻留时间	10	10	10	1	65535	ms																																																																																																																																																																																																																																																																																																																																																																																																																												
66	信号参数		velocity_reached_threshold	速度到达阈值	10	10	10	1	6000	rpm																																																																																																																																																																																																																																																																																																																																																																																																																												
68	信号参数		velocity_reached_time	速度到达驻留时间	10	10	10	1	65535	ms																																																																																																																																																																																																																																																																																																																																																																																																																												
70	信号参数		standstill_threshold	零速阈值	2	2	2	1	6000	rpm																																																																																																																																																																																																																																																																																																																																																																																																																												
72	信号参数		standstill_time	零速驻留时间	10	10	10	1	65535	ms																																																																																																																																																																																																																																																																																																																																																																																																																												
74	保护功能参数	following_error_monitoring_enable	跟随误差监视使能	0=关闭	0=关闭	1	0	1																																																																																																																																																																																																																																																																																																																																																																																																																														
76	保护功能参数	following_error_threshold1	跟随误差阈值1	-6	-6	-6	-16	16	2*π																																																																																																																																																																																																																																																																																																																																																																																																																													
78	保护功能参数	following_error_threshold2	跟随误差阈值2	-2	-2	-2	-16	16	2*π																																																																																																																																																																																																																																																																																																																																																																																																																													
80	保护功能参数	following_error_time	跟随误差过大驻留时间	200	200	200	1	65535	ms																																																																																																																																																																																																																																																																																																																																																																																																																													
82	保护功能参数	stall_protect_enable	堵转保护使能	0=关闭	0=关闭	0	0	1																																																																																																																																																																																																																																																																																																																																																																																																																														
84	保护功能参数	stall_protect_velocity_threshold	堵转保护速度阈值	2	2	2	1	6000	rpm																																																																																																																																																																																																																																																																																																																																																																																																																													
86	保护功能参数	stall_protect_torque_threshold	堵转保护转矩阈值	98	98	98	1	100	%																																																																																																																																																																																																																																																																																																																																																																																																																													
88	保护功能参数	stall_protect_time	堵转保护时间	200	200	200	1	65535	ms																																																																																																																																																																																																																																																																																																																																																																																																																													
90	保护功能参数	limit_protect_enable	硬限位保护使能	0=关闭	0=关闭	0	0	1																																																																																																																																																																																																																																																																																																																																																																																																																														
92	保护功能参数	limit_switch_priority	硬限位信号优先级	0=高开型信号	0=高开型信号	1	0	1																																																																																																																																																																																																																																																																																																																																																																																																																														
94	保护功能参数	limit_switch_swap	硬限位交换	0=关闭	0=关闭	0	0	1																																																																																																																																																																																																																																																																																																																																																																																																																														
96	保护功能参数	soft_limit_protect_enable	软限位保护使能	0=关闭	0=关闭	0	0	1																																																																																																																																																																																																																																																																																																																																																																																																																														
98	保护功能参数	soft_positive_limit	软正限位	0	0	0	-2147483647	2147483647	lu																																																																																																																																																																																																																																																																																																																																																																																																																													
100	保护功能参数	soft_negative_limit	软负限位	0	0	0	-2147483647	2147483647	lu																																																																																																																																																																																																																																																																																																																																																																																																																													
102	保护功能参数	emergency_stop_enable	急停功能使能	0=关闭	0=关闭	0	0	1																																																																																																																																																																																																																																																																																																																																																																																																																														
104																																																																																																																																																																																																																																																																																																																																																																																																																																						
106	回零参数	homing_method	零点搜索方法	0=扭矩回零	0=扭矩回零	0	0	1																																																																																																																																																																																																																																																																																																																																																																																																																														
108	回零参数	homing_dir	零点搜索方向	0=逆时针方向	0=逆时针方向	0	0	1																																																																																																																																																																																																																																																																																																																																																																																																																														
110	回零参数	homing_use_z_signal	z信号辅助回零	1=开启	1=开启	1	0	1																																																																																																																																																																																																																																																																																																																																																																																																																														
112	回零参数	homing_velocity1	零点搜索速度1	60	60	60	1	6000	rpm																																																																																																																																																																																																																																																																																																																																																																																																																													
114	回零参数	homing_velocity2	零点搜索速度2	10	10	10	1	6000	rpm																																																																																																																																																																																																																																																																																																																																																																																																																													
116	回零参数	homing_torque_threshold	扭矩回零阈值	98	98	98	1	100	%																																																																																																																																																																																																																																																																																																																																																																																																																													
118	回零参数	homing_torque_time	扭矩阈值到达驻留时间	10	10	10	1	65535	ms																																																																																																																																																																																																																																																																																																																																																																																																																													
120	回零参数	home_offset	零点搜索完成后偏移距离	0	0	0	-2147483647	2147483647	lu																																																																																																																																																																																																																																																																																																																																																																																																																													
122																																																																																																																																																																																																																																																																																																																																																																																																																																						
124																																																																																																																																																																																																																																																																																																																																																																																																																																						
126																																																																																																																																																																																																																																																																																																																																																																																																																																						
128																																																																																																																																																																																																																																																																																																																																																																																																																																						
130	点动参数	jog_velocity	JOG点动速度	60	60	60	1	6000	rpm																																																																																																																																																																																																																																																																																																																																																																																																																													
132	点动参数	jog_increase_distance	JOG点动距离	-2	-2	-2	-16	16	2*π																																																																																																																																																																																																																																																																																																																																																																																																																													
134	程序块参数	program_block_operation_mode	程序块运行模式	1=循环运行模式	1=循环运行模式	0	0	1																																																																																																																																																																																																																																																																																																																																																																																																																														
136	程序块参数	program_block_start_step	程序块起始步	1	1	1	1	16																																																																																																																																																																																																																																																																																																																																																																																																																														
138	程序块参数	program_block_end_step	程序块结束步	2	2	1	1	16																																																																																																																																																																																																																																																																																																																																																																																																																														
140	程序块	program_block_step[1].Xtarget	程序步[1]目标位置	0	0	0	-2147483647	2147483647	lu																																																																																																																																																																																																																																																																																																																																																																																																																													
142	程序块	program_block_step[1].Vtarget	程序步[1]目标速度	5000	5000	1	1	2147483647	lu/s																																																																																																																																																																																																																																																																																																																																																																																																																													
2、参数 homing_method = 0	使用扭矩回零。																																																																																																																																																																																																																																																																																																																																																																																																																																					
3、参数 homing_use_z_signal = 1	开启 z 信号辅助回零。																																																																																																																																																																																																																																																																																																																																																																																																																																					
4、参数 homing_torque_threshold = 98	扭矩回零阈值设置为 98%。																																																																																																																																																																																																																																																																																																																																																																																																																																					
5、切换运动模式至主动回零模式。	将设备运动模式切换到主动回零模式并使其能。																																																																																																																																																																																																																																																																																																																																																																																																																																					
6、暂停任务按钮设置为绿灯状态。	让设备不暂停任务。																																																																																																																																																																																																																																																																																																																																																																																																																																					
7、取消任务按钮设置为绿灯状态。	让设备不取消任务。																																																																																																																																																																																																																																																																																																																																																																																																																																					
8、启动任务按钮。	设备按照参数表设定的回零参数进行主动回零运动。																																																																																																																																																																																																																																																																																																																																																																																																																																					

5.3.4.4.3 硬限位回零

主动回零模式-硬限位回零		
步骤	作用	图示
1、参数 limit_protect_enable = 1	使能硬限位功能。	
2、参数 limit_switch_polarity = 0(常开型) 或 = 1(常闭型)	根据硬件开关输出极性设置常开型或常闭型。	
3、参数 homing_method = 1	使用限位回零。	
4、参数 homing_use_z_signal = 0	关闭 z 信号辅助回零。	
5、切换运动模式至主动回零模式。	将设备运动模式切换到主动回零模式并使能。	
6、暂停任务按钮设置为绿灯状态。	让设备不暂停任务。	
7、取消任务按钮设置为绿灯状态。	让设备不取消任务。	
8、启动任务按钮。	设备按照参数表设定的回零参数进行主动回零运动。	

5.3.4.4.4 硬限位+编码器 z 信号

主动回零模式-硬限位回零+编码器 z 信号																																																																																																																																																																																																																																																																																																																																																																																																																																						
步骤	作用	图示																																																																																																																																																																																																																																																																																																																																																																																																																																				
1、参数 limit_protect_enable = 1	使能硬限位功能。	<table border="1"> <thead> <tr> <th>参数号</th> <th>参数组</th> <th>参数名</th> <th>描述</th> <th>设置值</th> <th>当前值</th> <th>出厂值</th> <th>最小值</th> <th>最大值</th> <th>单</th> </tr> </thead> <tbody> <tr><td>62</td><td>信号参数</td><td>target_reached_threshold</td><td>位置到达阈值</td><td>-10</td><td>-10</td><td>-10</td><td>-16</td><td>16</td><td>2^</td></tr> <tr><td>64</td><td>信号参数</td><td>target_reached_time</td><td>位置到达驻留时间</td><td>10</td><td>10</td><td>10</td><td>1</td><td>65535</td><td>ms</td></tr> <tr><td>66</td><td>信号参数</td><td>velocity_reached_threshold</td><td>速度到达阈值</td><td>10</td><td>10</td><td>10</td><td>1</td><td>6000</td><td>rpr</td></tr> <tr><td>68</td><td>信号参数</td><td>velocity_reached_time</td><td>速度到达驻留时间</td><td>10</td><td>10</td><td>10</td><td>1</td><td>65535</td><td>ms</td></tr> <tr><td>70</td><td>信号参数</td><td>standstill_threshold</td><td>零速阈值</td><td>2</td><td>2</td><td>2</td><td>1</td><td>6000</td><td>rpr</td></tr> <tr><td>72</td><td>信号参数</td><td>standstill_time</td><td>零速驻留时间</td><td>10</td><td>10</td><td>10</td><td>1</td><td>65535</td><td>ms</td></tr> <tr><td>74</td><td>保护功能参数</td><td>following_error_monitoring_enable</td><td>跟随误差监视使能</td><td>0=关闭</td><td>0=关闭</td><td>1</td><td>0</td><td>1</td><td></td></tr> <tr><td>76</td><td>保护功能参数</td><td>following_error_threshold1</td><td>跟随误差阈值1</td><td>-6</td><td>-6</td><td>-6</td><td>-16</td><td>16</td><td>2^</td></tr> <tr><td>78</td><td>保护功能参数</td><td>following_error_threshold2</td><td>跟随误差阈值2</td><td>-2</td><td>-2</td><td>-2</td><td>-16</td><td>16</td><td>2^</td></tr> <tr><td>80</td><td>保护功能参数</td><td>following_error_time</td><td>跟随误差过大驻留时间</td><td>200</td><td>200</td><td>200</td><td>1</td><td>65535</td><td>ms</td></tr> <tr><td>82</td><td>保护功能参数</td><td>stall_protect_enable</td><td>堵转保护使能</td><td>0=关闭</td><td>0=关闭</td><td>0</td><td>0</td><td>1</td><td></td></tr> <tr><td>84</td><td>保护功能参数</td><td>stall_protect_velocity_threshold</td><td>堵转保护速度阈值</td><td>2</td><td>2</td><td>2</td><td>1</td><td>6000</td><td>rpr</td></tr> <tr><td>86</td><td>保护功能参数</td><td>stall_protect_torque_threshold</td><td>堵转保护转矩阈值</td><td>98</td><td>98</td><td>98</td><td>1</td><td>100</td><td>%</td></tr> <tr><td>88</td><td>保护功能参数</td><td>stall_protect_time</td><td>堵转保护时间</td><td>200</td><td>200</td><td>200</td><td>1</td><td>65535</td><td>ms</td></tr> <tr><td>90</td><td>保护功能参数</td><td>limp_protect_enable</td><td>硬限位保护使能</td><td>1=开启</td><td>1=开启</td><td>0</td><td>0</td><td>1</td><td></td></tr> <tr><td>92</td><td>保护功能参数</td><td>limp_protect_polarity</td><td>硬限位信号极性</td><td>0=常开型信号</td><td>0=常开型信号</td><td>0</td><td>0</td><td>1</td><td></td></tr> <tr><td>94</td><td>保护功能参数</td><td>limp_switch_time</td><td>硬限位时间</td><td>0=关闭</td><td>0=关闭</td><td>0</td><td>0</td><td>1</td><td></td></tr> <tr><td>96</td><td>保护功能参数</td><td>soft_limit_protect_enable</td><td>软限位保护使能</td><td>0=关闭</td><td>0=关闭</td><td>0</td><td>0</td><td>1</td><td></td></tr> <tr><td>98</td><td>保护功能参数</td><td>soft_positive_limit</td><td>软正限位</td><td>0</td><td>0</td><td>0</td><td>-2147483647</td><td>2147483647</td><td>ku</td></tr> <tr><td>100</td><td>保护功能参数</td><td>soft_negative_limit</td><td>软负限位</td><td>0</td><td>0</td><td>0</td><td>-2147483647</td><td>2147483647</td><td>ku</td></tr> <tr><td>102</td><td>保护功能参数</td><td>emergency_stop_enable</td><td>急停功能使能</td><td>0=关闭</td><td>0=关闭</td><td>0</td><td>0</td><td>1</td><td></td></tr> <tr><td>104</td><td></td><td></td><td></td><td></td><td></td><td></td><td></td><td></td><td></td></tr> <tr><td>106</td><td>回零参数</td><td>homing_method</td><td>零点搜索方法</td><td>1=限位回零</td><td>1=限位回零</td><td>0</td><td>0</td><td>1</td><td></td></tr> <tr><td>108</td><td>回零参数</td><td>homing_dir</td><td>零点搜索方向</td><td>0=正向回零</td><td>0=正向回零</td><td>0</td><td>0</td><td>1</td><td></td></tr> <tr><td>110</td><td>回零参数</td><td>homing_use_z_signal</td><td>z信号辅助回零</td><td>1=开启</td><td>1=开启</td><td>0</td><td>0</td><td>1</td><td></td></tr> <tr><td>112</td><td>回零参数</td><td>homing_velocity1</td><td>零点搜索速度1</td><td>60</td><td>60</td><td>60</td><td>1</td><td>6000</td><td>rpr</td></tr> <tr><td>114</td><td>回零参数</td><td>homing_velocity2</td><td>零点搜索速度2</td><td>10</td><td>10</td><td>10</td><td>1</td><td>6000</td><td>rpr</td></tr> <tr><td>116</td><td>回零参数</td><td>homing_torque_threshold</td><td>扭矩回零阈值</td><td>98</td><td>98</td><td>98</td><td>1</td><td>100</td><td>%</td></tr> <tr><td>118</td><td>回零参数</td><td>homing_torque_time</td><td>扭矩回零到达驻留时间</td><td>10</td><td>10</td><td>10</td><td>1</td><td>65535</td><td>ms</td></tr> <tr><td>120</td><td>回零参数</td><td>home_offset</td><td>零点搜索完成后偏移距离</td><td>0</td><td>0</td><td>0</td><td>-2147483647</td><td>2147483647</td><td>ku</td></tr> <tr><td>122</td><td></td><td></td><td></td><td></td><td></td><td></td><td></td><td></td><td></td></tr> <tr><td>124</td><td></td><td></td><td></td><td></td><td></td><td></td><td></td><td></td><td></td></tr> <tr><td>126</td><td></td><td></td><td></td><td></td><td></td><td></td><td></td><td></td><td></td></tr> <tr><td>128</td><td></td><td></td><td></td><td></td><td></td><td></td><td></td><td></td><td></td></tr> <tr><td>130</td><td>点动参数</td><td>jog_velocity</td><td>JOG点动速度</td><td>60</td><td>60</td><td>60</td><td>1</td><td>6000</td><td>rpr</td></tr> <tr><td>132</td><td>点动参数</td><td>jog_increase_distance</td><td>JOG点动距离</td><td>-2</td><td>-2</td><td>-2</td><td>-16</td><td>16</td><td>2^</td></tr> <tr><td>134</td><td>程序块参数</td><td>program_block_operation_mode</td><td>程序块运行模式</td><td>1=循环运行模式</td><td>1=循环运行模式</td><td>0</td><td>0</td><td>1</td><td></td></tr> <tr><td>136</td><td>程序块参数</td><td>program_block_start_step</td><td>程序块起始步</td><td>1</td><td>1</td><td>1</td><td>1</td><td>16</td><td></td></tr> <tr><td>138</td><td>程序块参数</td><td>program_block_end_step</td><td>程序块结束步</td><td>2</td><td>2</td><td>1</td><td>1</td><td>16</td><td></td></tr> <tr><td>140</td><td>程序块</td><td>program_block_step[1].target</td><td>程序步[1]目标位置</td><td>0</td><td>0</td><td>0</td><td>-2147483647</td><td>2147483647</td><td>ku</td></tr> <tr><td>142</td><td>程序块</td><td>program_block_step[1].vtarget</td><td>程序步[1]目标速度</td><td>5000</td><td>5000</td><td>1</td><td>1</td><td>2147483647</td><td>ku/</td></tr> </tbody> </table>	参数号	参数组	参数名	描述	设置值	当前值	出厂值	最小值	最大值	单	62	信号参数	target_reached_threshold	位置到达阈值	-10	-10	-10	-16	16	2^	64	信号参数	target_reached_time	位置到达驻留时间	10	10	10	1	65535	ms	66	信号参数	velocity_reached_threshold	速度到达阈值	10	10	10	1	6000	rpr	68	信号参数	velocity_reached_time	速度到达驻留时间	10	10	10	1	65535	ms	70	信号参数	standstill_threshold	零速阈值	2	2	2	1	6000	rpr	72	信号参数	standstill_time	零速驻留时间	10	10	10	1	65535	ms	74	保护功能参数	following_error_monitoring_enable	跟随误差监视使能	0=关闭	0=关闭	1	0	1		76	保护功能参数	following_error_threshold1	跟随误差阈值1	-6	-6	-6	-16	16	2^	78	保护功能参数	following_error_threshold2	跟随误差阈值2	-2	-2	-2	-16	16	2^	80	保护功能参数	following_error_time	跟随误差过大驻留时间	200	200	200	1	65535	ms	82	保护功能参数	stall_protect_enable	堵转保护使能	0=关闭	0=关闭	0	0	1		84	保护功能参数	stall_protect_velocity_threshold	堵转保护速度阈值	2	2	2	1	6000	rpr	86	保护功能参数	stall_protect_torque_threshold	堵转保护转矩阈值	98	98	98	1	100	%	88	保护功能参数	stall_protect_time	堵转保护时间	200	200	200	1	65535	ms	90	保护功能参数	limp_protect_enable	硬限位保护使能	1=开启	1=开启	0	0	1		92	保护功能参数	limp_protect_polarity	硬限位信号极性	0=常开型信号	0=常开型信号	0	0	1		94	保护功能参数	limp_switch_time	硬限位时间	0=关闭	0=关闭	0	0	1		96	保护功能参数	soft_limit_protect_enable	软限位保护使能	0=关闭	0=关闭	0	0	1		98	保护功能参数	soft_positive_limit	软正限位	0	0	0	-2147483647	2147483647	ku	100	保护功能参数	soft_negative_limit	软负限位	0	0	0	-2147483647	2147483647	ku	102	保护功能参数	emergency_stop_enable	急停功能使能	0=关闭	0=关闭	0	0	1		104										106	回零参数	homing_method	零点搜索方法	1=限位回零	1=限位回零	0	0	1		108	回零参数	homing_dir	零点搜索方向	0=正向回零	0=正向回零	0	0	1		110	回零参数	homing_use_z_signal	z信号辅助回零	1=开启	1=开启	0	0	1		112	回零参数	homing_velocity1	零点搜索速度1	60	60	60	1	6000	rpr	114	回零参数	homing_velocity2	零点搜索速度2	10	10	10	1	6000	rpr	116	回零参数	homing_torque_threshold	扭矩回零阈值	98	98	98	1	100	%	118	回零参数	homing_torque_time	扭矩回零到达驻留时间	10	10	10	1	65535	ms	120	回零参数	home_offset	零点搜索完成后偏移距离	0	0	0	-2147483647	2147483647	ku	122										124										126										128										130	点动参数	jog_velocity	JOG点动速度	60	60	60	1	6000	rpr	132	点动参数	jog_increase_distance	JOG点动距离	-2	-2	-2	-16	16	2^	134	程序块参数	program_block_operation_mode	程序块运行模式	1=循环运行模式	1=循环运行模式	0	0	1		136	程序块参数	program_block_start_step	程序块起始步	1	1	1	1	16		138	程序块参数	program_block_end_step	程序块结束步	2	2	1	1	16		140	程序块	program_block_step[1].target	程序步[1]目标位置	0	0	0	-2147483647	2147483647	ku	142	程序块	program_block_step[1].vtarget	程序步[1]目标速度	5000	5000	1	1	2147483647	ku/
参数号	参数组		参数名	描述	设置值	当前值	出厂值	最小值	最大值	单																																																																																																																																																																																																																																																																																																																																																																																																																												
62	信号参数		target_reached_threshold	位置到达阈值	-10	-10	-10	-16	16	2^																																																																																																																																																																																																																																																																																																																																																																																																																												
64	信号参数		target_reached_time	位置到达驻留时间	10	10	10	1	65535	ms																																																																																																																																																																																																																																																																																																																																																																																																																												
66	信号参数	velocity_reached_threshold	速度到达阈值	10	10	10	1	6000	rpr																																																																																																																																																																																																																																																																																																																																																																																																																													
68	信号参数	velocity_reached_time	速度到达驻留时间	10	10	10	1	65535	ms																																																																																																																																																																																																																																																																																																																																																																																																																													
70	信号参数	standstill_threshold	零速阈值	2	2	2	1	6000	rpr																																																																																																																																																																																																																																																																																																																																																																																																																													
72	信号参数	standstill_time	零速驻留时间	10	10	10	1	65535	ms																																																																																																																																																																																																																																																																																																																																																																																																																													
74	保护功能参数	following_error_monitoring_enable	跟随误差监视使能	0=关闭	0=关闭	1	0	1																																																																																																																																																																																																																																																																																																																																																																																																																														
76	保护功能参数	following_error_threshold1	跟随误差阈值1	-6	-6	-6	-16	16	2^																																																																																																																																																																																																																																																																																																																																																																																																																													
78	保护功能参数	following_error_threshold2	跟随误差阈值2	-2	-2	-2	-16	16	2^																																																																																																																																																																																																																																																																																																																																																																																																																													
80	保护功能参数	following_error_time	跟随误差过大驻留时间	200	200	200	1	65535	ms																																																																																																																																																																																																																																																																																																																																																																																																																													
82	保护功能参数	stall_protect_enable	堵转保护使能	0=关闭	0=关闭	0	0	1																																																																																																																																																																																																																																																																																																																																																																																																																														
84	保护功能参数	stall_protect_velocity_threshold	堵转保护速度阈值	2	2	2	1	6000	rpr																																																																																																																																																																																																																																																																																																																																																																																																																													
86	保护功能参数	stall_protect_torque_threshold	堵转保护转矩阈值	98	98	98	1	100	%																																																																																																																																																																																																																																																																																																																																																																																																																													
88	保护功能参数	stall_protect_time	堵转保护时间	200	200	200	1	65535	ms																																																																																																																																																																																																																																																																																																																																																																																																																													
90	保护功能参数	limp_protect_enable	硬限位保护使能	1=开启	1=开启	0	0	1																																																																																																																																																																																																																																																																																																																																																																																																																														
92	保护功能参数	limp_protect_polarity	硬限位信号极性	0=常开型信号	0=常开型信号	0	0	1																																																																																																																																																																																																																																																																																																																																																																																																																														
94	保护功能参数	limp_switch_time	硬限位时间	0=关闭	0=关闭	0	0	1																																																																																																																																																																																																																																																																																																																																																																																																																														
96	保护功能参数	soft_limit_protect_enable	软限位保护使能	0=关闭	0=关闭	0	0	1																																																																																																																																																																																																																																																																																																																																																																																																																														
98	保护功能参数	soft_positive_limit	软正限位	0	0	0	-2147483647	2147483647	ku																																																																																																																																																																																																																																																																																																																																																																																																																													
100	保护功能参数	soft_negative_limit	软负限位	0	0	0	-2147483647	2147483647	ku																																																																																																																																																																																																																																																																																																																																																																																																																													
102	保护功能参数	emergency_stop_enable	急停功能使能	0=关闭	0=关闭	0	0	1																																																																																																																																																																																																																																																																																																																																																																																																																														
104																																																																																																																																																																																																																																																																																																																																																																																																																																						
106	回零参数	homing_method	零点搜索方法	1=限位回零	1=限位回零	0	0	1																																																																																																																																																																																																																																																																																																																																																																																																																														
108	回零参数	homing_dir	零点搜索方向	0=正向回零	0=正向回零	0	0	1																																																																																																																																																																																																																																																																																																																																																																																																																														
110	回零参数	homing_use_z_signal	z信号辅助回零	1=开启	1=开启	0	0	1																																																																																																																																																																																																																																																																																																																																																																																																																														
112	回零参数	homing_velocity1	零点搜索速度1	60	60	60	1	6000	rpr																																																																																																																																																																																																																																																																																																																																																																																																																													
114	回零参数	homing_velocity2	零点搜索速度2	10	10	10	1	6000	rpr																																																																																																																																																																																																																																																																																																																																																																																																																													
116	回零参数	homing_torque_threshold	扭矩回零阈值	98	98	98	1	100	%																																																																																																																																																																																																																																																																																																																																																																																																																													
118	回零参数	homing_torque_time	扭矩回零到达驻留时间	10	10	10	1	65535	ms																																																																																																																																																																																																																																																																																																																																																																																																																													
120	回零参数	home_offset	零点搜索完成后偏移距离	0	0	0	-2147483647	2147483647	ku																																																																																																																																																																																																																																																																																																																																																																																																																													
122																																																																																																																																																																																																																																																																																																																																																																																																																																						
124																																																																																																																																																																																																																																																																																																																																																																																																																																						
126																																																																																																																																																																																																																																																																																																																																																																																																																																						
128																																																																																																																																																																																																																																																																																																																																																																																																																																						
130	点动参数	jog_velocity	JOG点动速度	60	60	60	1	6000	rpr																																																																																																																																																																																																																																																																																																																																																																																																																													
132	点动参数	jog_increase_distance	JOG点动距离	-2	-2	-2	-16	16	2^																																																																																																																																																																																																																																																																																																																																																																																																																													
134	程序块参数	program_block_operation_mode	程序块运行模式	1=循环运行模式	1=循环运行模式	0	0	1																																																																																																																																																																																																																																																																																																																																																																																																																														
136	程序块参数	program_block_start_step	程序块起始步	1	1	1	1	16																																																																																																																																																																																																																																																																																																																																																																																																																														
138	程序块参数	program_block_end_step	程序块结束步	2	2	1	1	16																																																																																																																																																																																																																																																																																																																																																																																																																														
140	程序块	program_block_step[1].target	程序步[1]目标位置	0	0	0	-2147483647	2147483647	ku																																																																																																																																																																																																																																																																																																																																																																																																																													
142	程序块	program_block_step[1].vtarget	程序步[1]目标速度	5000	5000	1	1	2147483647	ku/																																																																																																																																																																																																																																																																																																																																																																																																																													
2、参数 limit_switch_polarity = 0(常开型) 或 = 1(常闭型)	根据硬件开关输出极性设置常开型或常闭型。																																																																																																																																																																																																																																																																																																																																																																																																																																					
3、参数 homing_method = 1	使用限位回零。																																																																																																																																																																																																																																																																																																																																																																																																																																					
4、参数 homing_use_z_signal = 1	开启 z 信号辅助回零。																																																																																																																																																																																																																																																																																																																																																																																																																																					
5、切换运动模式至主动回零模式。	将设备运动模式切换到主动回零模式并使能。																																																																																																																																																																																																																																																																																																																																																																																																																																					
6、暂停任务按钮设置为绿灯状态。	让设备不暂停任务。																																																																																																																																																																																																																																																																																																																																																																																																																																					
7、取消任务按钮设置为绿灯状态。	让设备不取消任务。																																																																																																																																																																																																																																																																																																																																																																																																																																					
8、启动任务按钮。	设备按照参数表设定的回零参数进行主动回零运动。																																																																																																																																																																																																																																																																																																																																																																																																																																					

5.3.4.5 零点设置模式

零点设置模式		
步骤	作用	图示
1、切换运动模式至零点设置模式。	将设备运动模式切换到零点设置模式并使能。	
2、启动任务按钮。	设备将当前位置设定为零点。	

5.3.4.6程序块模式

5.3.4.6.1 单次运行模式

程序块模式-单次运行模式																																																																																																																																																																																																																																																																																																																																																																										
步骤	作用	图示																																																																																																																																																																																																																																																																																																																																																																								
1、参数 program_block_operation_mode = 0	程序块运行模式设置为单次运行模式。	<p>参数表 波形录制</p> <table border="1"> <thead> <tr> <th>参数号P</th> <th>参数组</th> <th>参数名</th> <th>描述</th> <th>设置值</th> <th>当前值</th> <th>出厂值</th> <th>最小值</th> <th>最大值</th> </tr> </thead> <tbody> <tr> <td>110</td> <td>回零参数</td> <td>homing_use_z_signal</td> <td>z信号辅助回零</td> <td>1=开启</td> <td>1=开启</td> <td>1</td> <td>0</td> <td>1</td> </tr> <tr> <td>112</td> <td>回零参数</td> <td>homing_velocity1</td> <td>零点搜索速度1</td> <td>60</td> <td>60</td> <td>60</td> <td>1</td> <td>6000</td> </tr> <tr> <td>114</td> <td>回零参数</td> <td>homing_velocity2</td> <td>零点搜索速度2</td> <td>10</td> <td>10</td> <td>10</td> <td>1</td> <td>6000</td> </tr> <tr> <td>116</td> <td>回零参数</td> <td>homing_torque_threshold</td> <td>扭矩回零阈值</td> <td>98</td> <td>98</td> <td>98</td> <td>1</td> <td>100</td> </tr> <tr> <td>118</td> <td>回零参数</td> <td>homing_torque_time</td> <td>扭矩阈值到达驻留时间</td> <td>10</td> <td>10</td> <td>10</td> <td>1</td> <td>65535</td> </tr> <tr> <td>120</td> <td>回零参数</td> <td>home_offset</td> <td>零点搜索完成后偏移距离</td> <td>0</td> <td>0</td> <td>0</td> <td>-2147483647</td> <td>2147483647</td> </tr> <tr> <td>122</td> <td></td> <td></td> <td></td> <td></td> <td></td> <td></td> <td></td> <td></td> </tr> <tr> <td>124</td> <td></td> <td></td> <td></td> <td></td> <td></td> <td></td> <td></td> <td></td> </tr> <tr> <td>126</td> <td></td> <td></td> <td></td> <td></td> <td></td> <td></td> <td></td> <td></td> </tr> <tr> <td>128</td> <td></td> <td></td> <td></td> <td></td> <td></td> <td></td> <td></td> <td></td> </tr> <tr> <td>130</td> <td>点动参数</td> <td>jog_velocity</td> <td>JOG点动速度</td> <td>60</td> <td>60</td> <td>60</td> <td>1</td> <td>6000</td> </tr> <tr> <td>132</td> <td>点动参数</td> <td>jog_increase_distance</td> <td>JOG寸动距离</td> <td>-2</td> <td>-2</td> <td>-2</td> <td>-16</td> <td>16</td> </tr> <tr> <td>134</td> <td>程序块参数</td> <td>program_block_operation_mode</td> <td>程序块运行模式</td> <td>0=单次运行模式</td> <td>0=单次运行模式</td> <td>0</td> <td>0</td> <td>1</td> </tr> <tr> <td>136</td> <td>程序块参数</td> <td>program_block_start_step</td> <td>程序块起始步</td> <td>1</td> <td>1</td> <td>1</td> <td>1</td> <td>16</td> </tr> <tr> <td>138</td> <td>程序块参数</td> <td>program_block_end_step</td> <td>程序块结束步</td> <td>2</td> <td>2</td> <td>1</td> <td>1</td> <td>16</td> </tr> <tr> <td>140</td> <td>程序块</td> <td>program_block_step[1].Xtarget</td> <td>程序步[1]目标位置</td> <td>0</td> <td>0</td> <td>0</td> <td>-2147483647</td> <td>2147483647</td> </tr> <tr> <td>142</td> <td>程序块</td> <td>program_block_step[1].Vtarget</td> <td>程序步[1]目标速度</td> <td>5000</td> <td>5000</td> <td>1</td> <td>1</td> <td>2147483647</td> </tr> <tr> <td>144</td> <td>程序块</td> <td>program_block_step[1].delay</td> <td>程序步[1]延时</td> <td>500</td> <td>500</td> <td>0</td> <td>0</td> <td>65535</td> </tr> <tr> <td>146</td> <td>程序块</td> <td>program_block_step[2].Xtarget</td> <td>程序步[2]目标位置</td> <td>10000</td> <td>10000</td> <td>0</td> <td>-2147483647</td> <td>2147483647</td> </tr> <tr> <td>148</td> <td>程序块</td> <td>program_block_step[2].Vtarget</td> <td>程序步[2]目标速度</td> <td>5000</td> <td>5000</td> <td>1</td> <td>1</td> <td>2147483647</td> </tr> <tr> <td>150</td> <td>程序块</td> <td>program_block_step[2].delay</td> <td>程序步[2]延时</td> <td>500</td> <td>500</td> <td>0</td> <td>0</td> <td>65535</td> </tr> <tr> <td>152</td> <td>程序块</td> <td>program_block_step[3].Xtarget</td> <td>程序步[3]目标位置</td> <td>0</td> <td>0</td> <td>0</td> <td>-2147483647</td> <td>2147483647</td> </tr> <tr> <td>154</td> <td>程序块</td> <td>program_block_step[3].Vtarget</td> <td>程序步[3]目标速度</td> <td>1</td> <td>1</td> <td>1</td> <td>1</td> <td>2147483647</td> </tr> <tr> <td>156</td> <td>程序块</td> <td>program_block_step[3].delay</td> <td>程序步[3]延时</td> <td>0</td> <td>0</td> <td>0</td> <td>0</td> <td>65535</td> </tr> <tr> <td>158</td> <td>程序块</td> <td>program_block_step[4].Xtarget</td> <td>程序步[4]目标位置</td> <td>0</td> <td>0</td> <td>0</td> <td>-2147483647</td> <td>2147483647</td> </tr> <tr> <td>160</td> <td>程序块</td> <td>program_block_step[4].Vtarget</td> <td>程序步[4]目标速度</td> <td>1</td> <td>1</td> <td>1</td> <td>1</td> <td>2147483647</td> </tr> <tr> <td>162</td> <td>程序块</td> <td>program_block_step[4].delay</td> <td>程序步[4]延时</td> <td>0</td> <td>0</td> <td>0</td> <td>0</td> <td>65535</td> </tr> <tr> <td>164</td> <td>程序块</td> <td>program_block_step[5].Xtarget</td> <td>程序步[5]目标位置</td> <td>0</td> <td>0</td> <td>0</td> <td>-2147483647</td> <td>2147483647</td> </tr> <tr> <td>166</td> <td>程序块</td> <td>program_block_step[5].Vtarget</td> <td>程序步[5]目标速度</td> <td>1</td> <td>1</td> <td>1</td> <td>1</td> <td>2147483647</td> </tr> <tr> <td>168</td> <td>程序块</td> <td>program_block_step[5].delay</td> <td>程序步[5]延时</td> <td>0</td> <td>0</td> <td>0</td> <td>0</td> <td>65535</td> </tr> <tr> <td>170</td> <td>程序块</td> <td>program_block_step[6].Xtarget</td> <td>程序步[6]目标位置</td> <td>0</td> <td>0</td> <td>0</td> <td>-2147483647</td> <td>2147483647</td> </tr> <tr> <td>172</td> <td>程序块</td> <td>program_block_step[6].Vtarget</td> <td>程序步[6]目标速度</td> <td>1</td> <td>1</td> <td>1</td> <td>1</td> <td>2147483647</td> </tr> <tr> <td>174</td> <td>程序块</td> <td>program_block_step[6].delay</td> <td>程序步[6]延时</td> <td>0</td> <td>0</td> <td>0</td> <td>0</td> <td>65535</td> </tr> <tr> <td>176</td> <td>程序块</td> <td>program_block_step[7].Xtarget</td> <td>程序步[7]目标位置</td> <td>0</td> <td>0</td> <td>0</td> <td>-2147483647</td> <td>2147483647</td> </tr> <tr> <td>178</td> <td>程序块</td> <td>program_block_step[7].Vtarget</td> <td>程序步[7]目标速度</td> <td>1</td> <td>1</td> <td>1</td> <td>1</td> <td>2147483647</td> </tr> <tr> <td>180</td> <td>程序块</td> <td>program_block_step[7].delay</td> <td>程序步[7]延时</td> <td>0</td> <td>0</td> <td>0</td> <td>0</td> <td>65535</td> </tr> <tr> <td>182</td> <td>程序块</td> <td>program_block_step[8].Xtarget</td> <td>程序步[8]目标位置</td> <td>0</td> <td>0</td> <td>0</td> <td>-2147483647</td> <td>2147483647</td> </tr> <tr> <td>184</td> <td>程序块</td> <td>program_block_step[8].Vtarget</td> <td>程序步[8]目标速度</td> <td>1</td> <td>1</td> <td>1</td> <td>1</td> <td>2147483647</td> </tr> <tr> <td>186</td> <td>程序块</td> <td>program_block_step[8].delay</td> <td>程序步[8]延时</td> <td>0</td> <td>0</td> <td>0</td> <td>0</td> <td>65535</td> </tr> </tbody> </table>	参数号P	参数组	参数名	描述	设置值	当前值	出厂值	最小值	最大值	110	回零参数	homing_use_z_signal	z信号辅助回零	1=开启	1=开启	1	0	1	112	回零参数	homing_velocity1	零点搜索速度1	60	60	60	1	6000	114	回零参数	homing_velocity2	零点搜索速度2	10	10	10	1	6000	116	回零参数	homing_torque_threshold	扭矩回零阈值	98	98	98	1	100	118	回零参数	homing_torque_time	扭矩阈值到达驻留时间	10	10	10	1	65535	120	回零参数	home_offset	零点搜索完成后偏移距离	0	0	0	-2147483647	2147483647	122									124									126									128									130	点动参数	jog_velocity	JOG点动速度	60	60	60	1	6000	132	点动参数	jog_increase_distance	JOG寸动距离	-2	-2	-2	-16	16	134	程序块参数	program_block_operation_mode	程序块运行模式	0=单次运行模式	0=单次运行模式	0	0	1	136	程序块参数	program_block_start_step	程序块起始步	1	1	1	1	16	138	程序块参数	program_block_end_step	程序块结束步	2	2	1	1	16	140	程序块	program_block_step[1].Xtarget	程序步[1]目标位置	0	0	0	-2147483647	2147483647	142	程序块	program_block_step[1].Vtarget	程序步[1]目标速度	5000	5000	1	1	2147483647	144	程序块	program_block_step[1].delay	程序步[1]延时	500	500	0	0	65535	146	程序块	program_block_step[2].Xtarget	程序步[2]目标位置	10000	10000	0	-2147483647	2147483647	148	程序块	program_block_step[2].Vtarget	程序步[2]目标速度	5000	5000	1	1	2147483647	150	程序块	program_block_step[2].delay	程序步[2]延时	500	500	0	0	65535	152	程序块	program_block_step[3].Xtarget	程序步[3]目标位置	0	0	0	-2147483647	2147483647	154	程序块	program_block_step[3].Vtarget	程序步[3]目标速度	1	1	1	1	2147483647	156	程序块	program_block_step[3].delay	程序步[3]延时	0	0	0	0	65535	158	程序块	program_block_step[4].Xtarget	程序步[4]目标位置	0	0	0	-2147483647	2147483647	160	程序块	program_block_step[4].Vtarget	程序步[4]目标速度	1	1	1	1	2147483647	162	程序块	program_block_step[4].delay	程序步[4]延时	0	0	0	0	65535	164	程序块	program_block_step[5].Xtarget	程序步[5]目标位置	0	0	0	-2147483647	2147483647	166	程序块	program_block_step[5].Vtarget	程序步[5]目标速度	1	1	1	1	2147483647	168	程序块	program_block_step[5].delay	程序步[5]延时	0	0	0	0	65535	170	程序块	program_block_step[6].Xtarget	程序步[6]目标位置	0	0	0	-2147483647	2147483647	172	程序块	program_block_step[6].Vtarget	程序步[6]目标速度	1	1	1	1	2147483647	174	程序块	program_block_step[6].delay	程序步[6]延时	0	0	0	0	65535	176	程序块	program_block_step[7].Xtarget	程序步[7]目标位置	0	0	0	-2147483647	2147483647	178	程序块	program_block_step[7].Vtarget	程序步[7]目标速度	1	1	1	1	2147483647	180	程序块	program_block_step[7].delay	程序步[7]延时	0	0	0	0	65535	182	程序块	program_block_step[8].Xtarget	程序步[8]目标位置	0	0	0	-2147483647	2147483647	184	程序块	program_block_step[8].Vtarget	程序步[8]目标速度	1	1	1	1	2147483647	186	程序块	program_block_step[8].delay	程序步[8]延时	0	0	0	0	65535
参数号P	参数组		参数名	描述	设置值	当前值	出厂值	最小值	最大值																																																																																																																																																																																																																																																																																																																																																																	
110	回零参数		homing_use_z_signal	z信号辅助回零	1=开启	1=开启	1	0	1																																																																																																																																																																																																																																																																																																																																																																	
112	回零参数		homing_velocity1	零点搜索速度1	60	60	60	1	6000																																																																																																																																																																																																																																																																																																																																																																	
114	回零参数		homing_velocity2	零点搜索速度2	10	10	10	1	6000																																																																																																																																																																																																																																																																																																																																																																	
116	回零参数		homing_torque_threshold	扭矩回零阈值	98	98	98	1	100																																																																																																																																																																																																																																																																																																																																																																	
118	回零参数		homing_torque_time	扭矩阈值到达驻留时间	10	10	10	1	65535																																																																																																																																																																																																																																																																																																																																																																	
120	回零参数		home_offset	零点搜索完成后偏移距离	0	0	0	-2147483647	2147483647																																																																																																																																																																																																																																																																																																																																																																	
122																																																																																																																																																																																																																																																																																																																																																																										
124																																																																																																																																																																																																																																																																																																																																																																										
126																																																																																																																																																																																																																																																																																																																																																																										
128																																																																																																																																																																																																																																																																																																																																																																										
130	点动参数	jog_velocity	JOG点动速度	60	60	60	1	6000																																																																																																																																																																																																																																																																																																																																																																		
132	点动参数	jog_increase_distance	JOG寸动距离	-2	-2	-2	-16	16																																																																																																																																																																																																																																																																																																																																																																		
134	程序块参数	program_block_operation_mode	程序块运行模式	0=单次运行模式	0=单次运行模式	0	0	1																																																																																																																																																																																																																																																																																																																																																																		
136	程序块参数	program_block_start_step	程序块起始步	1	1	1	1	16																																																																																																																																																																																																																																																																																																																																																																		
138	程序块参数	program_block_end_step	程序块结束步	2	2	1	1	16																																																																																																																																																																																																																																																																																																																																																																		
140	程序块	program_block_step[1].Xtarget	程序步[1]目标位置	0	0	0	-2147483647	2147483647																																																																																																																																																																																																																																																																																																																																																																		
142	程序块	program_block_step[1].Vtarget	程序步[1]目标速度	5000	5000	1	1	2147483647																																																																																																																																																																																																																																																																																																																																																																		
144	程序块	program_block_step[1].delay	程序步[1]延时	500	500	0	0	65535																																																																																																																																																																																																																																																																																																																																																																		
146	程序块	program_block_step[2].Xtarget	程序步[2]目标位置	10000	10000	0	-2147483647	2147483647																																																																																																																																																																																																																																																																																																																																																																		
148	程序块	program_block_step[2].Vtarget	程序步[2]目标速度	5000	5000	1	1	2147483647																																																																																																																																																																																																																																																																																																																																																																		
150	程序块	program_block_step[2].delay	程序步[2]延时	500	500	0	0	65535																																																																																																																																																																																																																																																																																																																																																																		
152	程序块	program_block_step[3].Xtarget	程序步[3]目标位置	0	0	0	-2147483647	2147483647																																																																																																																																																																																																																																																																																																																																																																		
154	程序块	program_block_step[3].Vtarget	程序步[3]目标速度	1	1	1	1	2147483647																																																																																																																																																																																																																																																																																																																																																																		
156	程序块	program_block_step[3].delay	程序步[3]延时	0	0	0	0	65535																																																																																																																																																																																																																																																																																																																																																																		
158	程序块	program_block_step[4].Xtarget	程序步[4]目标位置	0	0	0	-2147483647	2147483647																																																																																																																																																																																																																																																																																																																																																																		
160	程序块	program_block_step[4].Vtarget	程序步[4]目标速度	1	1	1	1	2147483647																																																																																																																																																																																																																																																																																																																																																																		
162	程序块	program_block_step[4].delay	程序步[4]延时	0	0	0	0	65535																																																																																																																																																																																																																																																																																																																																																																		
164	程序块	program_block_step[5].Xtarget	程序步[5]目标位置	0	0	0	-2147483647	2147483647																																																																																																																																																																																																																																																																																																																																																																		
166	程序块	program_block_step[5].Vtarget	程序步[5]目标速度	1	1	1	1	2147483647																																																																																																																																																																																																																																																																																																																																																																		
168	程序块	program_block_step[5].delay	程序步[5]延时	0	0	0	0	65535																																																																																																																																																																																																																																																																																																																																																																		
170	程序块	program_block_step[6].Xtarget	程序步[6]目标位置	0	0	0	-2147483647	2147483647																																																																																																																																																																																																																																																																																																																																																																		
172	程序块	program_block_step[6].Vtarget	程序步[6]目标速度	1	1	1	1	2147483647																																																																																																																																																																																																																																																																																																																																																																		
174	程序块	program_block_step[6].delay	程序步[6]延时	0	0	0	0	65535																																																																																																																																																																																																																																																																																																																																																																		
176	程序块	program_block_step[7].Xtarget	程序步[7]目标位置	0	0	0	-2147483647	2147483647																																																																																																																																																																																																																																																																																																																																																																		
178	程序块	program_block_step[7].Vtarget	程序步[7]目标速度	1	1	1	1	2147483647																																																																																																																																																																																																																																																																																																																																																																		
180	程序块	program_block_step[7].delay	程序步[7]延时	0	0	0	0	65535																																																																																																																																																																																																																																																																																																																																																																		
182	程序块	program_block_step[8].Xtarget	程序步[8]目标位置	0	0	0	-2147483647	2147483647																																																																																																																																																																																																																																																																																																																																																																		
184	程序块	program_block_step[8].Vtarget	程序步[8]目标速度	1	1	1	1	2147483647																																																																																																																																																																																																																																																																																																																																																																		
186	程序块	program_block_step[8].delay	程序步[8]延时	0	0	0	0	65535																																																																																																																																																																																																																																																																																																																																																																		
2、参数 program_block_start_step = 1	程序块起始步设置为1。																																																																																																																																																																																																																																																																																																																																																																									
3、参数 program_block_end_step = 2	程序块结束步设置为2。																																																																																																																																																																																																																																																																																																																																																																									
4、参数 program_block_step[1].Xtarget = 0	程序步1 目标位置设置为 0 lu。																																																																																																																																																																																																																																																																																																																																																																									
5、参数 program_block_step[1].Vtarget = 5000	程序步1 目标速度设置为 5000 lu/s。																																																																																																																																																																																																																																																																																																																																																																									
6、参数 program_block_step[1].delay = 500	程序步1 延时设置为 500 ms。																																																																																																																																																																																																																																																																																																																																																																									
7、参数 program_block_step[2].Xtarget = 10000	程序步2 目标位置设置为 10000 lu。																																																																																																																																																																																																																																																																																																																																																																									
8、参数 program_block_step[2].Vtarget = 5000	程序步2 目标速度设置为 5000 lu/s。																																																																																																																																																																																																																																																																																																																																																																									
9、参数 program_block_step[2].delay = 500	程序步2 延时设置为 500 ms。																																																																																																																																																																																																																																																																																																																																																																									

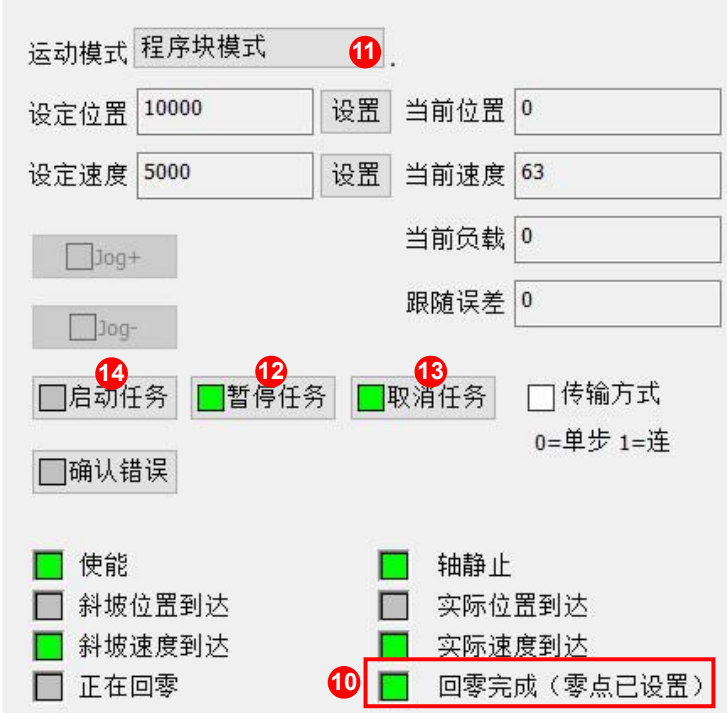
10、确认轴已回零	程序块模式需要零点作为的参考点。	 <p>运动模式 程序块模式 11</p> <p>设定位置 10000 设置 当前位置 0</p> <p>设定速度 5000 设置 当前速度 63</p> <p><input type="checkbox"/> Jog+ 当前负载 0</p> <p><input type="checkbox"/> Jog- 跟随误差 0</p> <p><input type="checkbox"/> 启动任务 14 <input checked="" type="checkbox"/> 暂停任务 12 <input checked="" type="checkbox"/> 取消任务 13 <input type="checkbox"/> 传输方式</p> <p><input type="checkbox"/> 确认错误 0=单步 1=连</p> <p><input checked="" type="checkbox"/> 使能 <input checked="" type="checkbox"/> 轴静止</p> <p><input type="checkbox"/> 斜坡位置到达 <input type="checkbox"/> 实际位置到达</p> <p><input checked="" type="checkbox"/> 斜坡速度到达 <input checked="" type="checkbox"/> 实际速度到达</p> <p><input type="checkbox"/> 正在回零 10 <input checked="" type="checkbox"/> 回零完成 (零点已设置)</p>
11、切换运动模式至程序块模式。	将设备运动模式切换到程序块模式并使其能。	
12、暂停任务按钮设置为绿灯状态。	让设备不暂停任务。	
13、取消任务按钮设置为绿灯状态。	让设备不取消任务。	
14、启动任务按钮。	设备按照参数表设定的程序块参数进行运动。	

5.3.4.6.2 循环运行模式

程序块模式-循环运行模式		
步骤	作用	图示
1、参数 program_block_operation_mode = 1	程序块运行模式设置为循环运行模式。	
2、参数 program_block_start_step = 1	程序块起始步设置为1。	
3、参数 program_block_end_step = 2	程序块结束步设置为2。	
4、参数 program_block_step[1].Xtarget = 0	程序步1 目标位置设置为0。	
5、参数 program_block_step[1].Vtarget = 5000	程序步1 目标速度设置为5000。	
6、参数 program_block_step[1].delay = 500	程序步1 延时设置为500。	
7、参数 program_block_step[2].Xtarget = 10000	程序步2 目标位置设置为10000。	
8、参数 program_block_step[2].Vtarget = 5000	程序步2 目标速度设置为5000。	
9、参数 program_block_step[2].delay = 500	程序步2 延时设置为500。	
10、确认轴已回零	设备程序块模式需要零点作为的参考点。	

参数表 波形录制

参数号P	参数组	参数名	描述	设置值	当前值	出厂值	最小值	最大值
110	回零参数	homing_use_z_signal	z信号辅助回零	1=开启	1=开启	1	0	1
112	回零参数	homing_velocity1	零点搜索速度1	60	60	60	1	6000
114	回零参数	homing_velocity2	零点搜索速度2	10	10	10	1	6000
116	回零参数	homing_torque_threshold	扭矩回零阈值	98	98	98	1	100
118	回零参数	homing_torque_time	扭矩回零时间	10	10	10	1	65535
120	回零参数	home_offset	零点搜索完成后偏移距离	0	0	0	-2147483647	2147483647
122								
124								
126								
128								
130	点动参数	jog_velocity	JOG点动速度	60	60	60	1	6000
132	点动参数	jog_increase_distance	JOG寸动距离	-2	-2	-2	-16	16
134	程序块参数	program_block_operation_mode	程序块运行模式	1=循环运行模式	1=循环运行模式	0	0	1
136	程序块参数	program_block_start_step	程序块起始步	1	1	1	1	16
138	程序块参数	program_block_end_step	程序块结束步	2	2	1	1	16
140	程序块	program_block_step[1].Xtarget	程序步[1].目标位置	0	0	0	-2147483647	2147483647
142	程序块	program_block_step[1].Vtarget	程序步[1].目标速度	5000	5000	1	1	2147483647
144	程序块	program_block_step[1].delay	程序步[1].延时	500	500	0	0	65535
146	程序块	program_block_step[2].Xtarget	程序步[2].目标位置	10000	10000	0	-2147483647	2147483647
148	程序块	program_block_step[2].Vtarget	程序步[2].目标速度	5000	5000	1	1	2147483647
150	程序块	program_block_step[2].delay	程序步[2].延时	500	500	0	0	65535
152	程序块	program_block_step[3].Xtarget	程序步[3].目标位置	0	0	0	-2147483647	2147483647
154	程序块	program_block_step[3].Vtarget	程序步[3].目标速度	1	1	1	1	2147483647
156	程序块	program_block_step[3].delay	程序步[3].延时	0	0	0	0	65535
158	程序块	program_block_step[4].Xtarget	程序步[4].目标位置	0	0	0	-2147483647	2147483647
160	程序块	program_block_step[4].Vtarget	程序步[4].目标速度	1	1	1	1	2147483647
162	程序块	program_block_step[4].delay	程序步[4].延时	0	0	0	0	65535
164	程序块	program_block_step[5].Xtarget	程序步[5].目标位置	0	0	0	-2147483647	2147483647
166	程序块	program_block_step[5].Vtarget	程序步[5].目标速度	1	1	1	1	2147483647
168	程序块	program_block_step[5].delay	程序步[5].延时	0	0	0	0	65535
170	程序块	program_block_step[6].Xtarget	程序步[6].目标位置	0	0	0	-2147483647	2147483647
172	程序块	program_block_step[6].Vtarget	程序步[6].目标速度	1	1	1	1	2147483647
174	程序块	program_block_step[6].delay	程序步[6].延时	0	0	0	0	65535
176	程序块	program_block_step[7].Xtarget	程序步[7].目标位置	0	0	0	-2147483647	2147483647
178	程序块	program_block_step[7].Vtarget	程序步[7].目标速度	1	1	1	1	2147483647
180	程序块	program_block_step[7].delay	程序步[7].延时	0	0	0	0	65535
182	程序块	program_block_step[8].Xtarget	程序步[8].目标位置	0	0	0	-2147483647	2147483647
184	程序块	program_block_step[8].Vtarget	程序步[8].目标速度	1	1	1	1	2147483647
186	程序块	program_block_step[8].delay	程序步[8].延时	0	0	0	0	65535

11、切换运动模式至程序块模式。	将设备运动模式切换到程序块模式并启用。	
12、暂停任务按钮设置为绿灯状态。	让设备不暂停任务。	
13、取消任务按钮设置为绿灯状态。	让设备不取消任务。	
14、启动任务按钮。	设备按照参数表设定的程序块参数进行运动。	

5.3.4.7 点动模式

点动模式																																																																																																																																																																																																																																																																																																																																																																										
步骤	作用	图示																																																																																																																																																																																																																																																																																																																																																																								
1、参数 jog_velocity = 60	设置点动速度为 60rpm。	<p>参数表 波形录制</p> <table border="1"> <thead> <tr> <th>参数号P</th> <th>参数组</th> <th>参数名</th> <th>描述</th> <th>设置值</th> <th>当前值</th> <th>出厂值</th> <th>最小值</th> <th>最大值</th> </tr> </thead> <tbody> <tr><td>110</td><td>回零参数</td><td>homing_use_z_signal</td><td>z轴号辅助回零</td><td>1=开启</td><td>1=开启</td><td>1</td><td>0</td><td>1</td></tr> <tr><td>112</td><td>回零参数</td><td>homing_velocity1</td><td>零点搜索速度1</td><td>60</td><td>60</td><td>60</td><td>1</td><td>6000</td></tr> <tr><td>114</td><td>回零参数</td><td>homing_velocity2</td><td>零点搜索速度2</td><td>10</td><td>10</td><td>10</td><td>1</td><td>6000</td></tr> <tr><td>116</td><td>回零参数</td><td>homing_torque_threshold</td><td>扭矩回零阈值</td><td>98</td><td>98</td><td>98</td><td>1</td><td>100</td></tr> <tr><td>118</td><td>回零参数</td><td>homing_torque_time</td><td>扭矩阈值到达后延迟时间</td><td>10</td><td>10</td><td>10</td><td>1</td><td>65535</td></tr> <tr><td>120</td><td>回零参数</td><td>home_offset</td><td>零点搜索完成后偏移距离</td><td>0</td><td>0</td><td>0</td><td>-2147483647</td><td>2147483647</td></tr> <tr><td>122</td><td></td><td></td><td></td><td></td><td></td><td></td><td></td><td></td></tr> <tr><td>124</td><td></td><td></td><td></td><td></td><td></td><td></td><td></td><td></td></tr> <tr><td>126</td><td></td><td></td><td></td><td></td><td></td><td></td><td></td><td></td></tr> <tr><td>128</td><td></td><td></td><td></td><td></td><td></td><td></td><td></td><td></td></tr> <tr><td>130</td><td>点动参数</td><td>jog_velocity</td><td>JOG点动速度</td><td>60</td><td>60</td><td>60</td><td>1</td><td>80</td></tr> <tr><td>132</td><td>点动参数</td><td>jog_increase_distance</td><td>JOG寸动距离</td><td>-2</td><td>-2</td><td>-2</td><td>-16</td><td>16</td></tr> <tr><td>134</td><td>程序块参数</td><td>program_block_operation_mode</td><td>程序块运行模式</td><td>1=循环运行模式</td><td>1=循环运行模式</td><td>0</td><td>0</td><td>1</td></tr> <tr><td>136</td><td>程序块参数</td><td>program_block_start_step</td><td>程序块起始步</td><td>1</td><td>1</td><td>1</td><td>1</td><td>16</td></tr> <tr><td>138</td><td>程序块参数</td><td>program_block_end_step</td><td>程序块结束步</td><td>2</td><td>2</td><td>1</td><td>1</td><td>16</td></tr> <tr><td>140</td><td>程序块</td><td>program_block_step[1].Xtarget</td><td>程序步[1].目标位置</td><td>0</td><td>0</td><td>0</td><td>-2147483647</td><td>2147483647</td></tr> <tr><td>142</td><td>程序块</td><td>program_block_step[1].Vtarget</td><td>程序步[1].目标速度</td><td>5000</td><td>5000</td><td>1</td><td>1</td><td>2147483647</td></tr> <tr><td>144</td><td>程序块</td><td>program_block_step[1].delay</td><td>程序步[1].延时</td><td>500</td><td>500</td><td>0</td><td>0</td><td>65535</td></tr> <tr><td>146</td><td>程序块</td><td>program_block_step[2].Xtarget</td><td>程序步[2].目标位置</td><td>10000</td><td>10000</td><td>0</td><td>-2147483647</td><td>2147483647</td></tr> <tr><td>148</td><td>程序块</td><td>program_block_step[2].Vtarget</td><td>程序步[2].目标速度</td><td>5000</td><td>5000</td><td>1</td><td>1</td><td>2147483647</td></tr> <tr><td>150</td><td>程序块</td><td>program_block_step[2].delay</td><td>程序步[2].延时</td><td>500</td><td>500</td><td>0</td><td>0</td><td>65535</td></tr> <tr><td>152</td><td>程序块</td><td>program_block_step[3].Xtarget</td><td>程序步[3].目标位置</td><td>0</td><td>0</td><td>0</td><td>-2147483647</td><td>2147483647</td></tr> <tr><td>154</td><td>程序块</td><td>program_block_step[3].Vtarget</td><td>程序步[3].目标速度</td><td>1</td><td>1</td><td>1</td><td>1</td><td>2147483647</td></tr> <tr><td>156</td><td>程序块</td><td>program_block_step[3].delay</td><td>程序步[3].延时</td><td>0</td><td>0</td><td>0</td><td>0</td><td>65535</td></tr> <tr><td>158</td><td>程序块</td><td>program_block_step[4].Xtarget</td><td>程序步[4].目标位置</td><td>0</td><td>0</td><td>0</td><td>-2147483647</td><td>2147483647</td></tr> <tr><td>160</td><td>程序块</td><td>program_block_step[4].Vtarget</td><td>程序步[4].目标速度</td><td>1</td><td>1</td><td>1</td><td>1</td><td>2147483647</td></tr> <tr><td>162</td><td>程序块</td><td>program_block_step[4].delay</td><td>程序步[4].延时</td><td>0</td><td>0</td><td>0</td><td>0</td><td>65535</td></tr> <tr><td>164</td><td>程序块</td><td>program_block_step[5].Xtarget</td><td>程序步[5].目标位置</td><td>0</td><td>0</td><td>0</td><td>-2147483647</td><td>2147483647</td></tr> <tr><td>166</td><td>程序块</td><td>program_block_step[5].Vtarget</td><td>程序步[5].目标速度</td><td>1</td><td>1</td><td>1</td><td>1</td><td>2147483647</td></tr> <tr><td>168</td><td>程序块</td><td>program_block_step[5].delay</td><td>程序步[5].延时</td><td>0</td><td>0</td><td>0</td><td>0</td><td>65535</td></tr> <tr><td>170</td><td>程序块</td><td>program_block_step[6].Xtarget</td><td>程序步[6].目标位置</td><td>0</td><td>0</td><td>0</td><td>-2147483647</td><td>2147483647</td></tr> <tr><td>172</td><td>程序块</td><td>program_block_step[6].Vtarget</td><td>程序步[6].目标速度</td><td>1</td><td>1</td><td>1</td><td>1</td><td>2147483647</td></tr> <tr><td>174</td><td>程序块</td><td>program_block_step[6].delay</td><td>程序步[6].延时</td><td>0</td><td>0</td><td>0</td><td>0</td><td>65535</td></tr> <tr><td>176</td><td>程序块</td><td>program_block_step[7].Xtarget</td><td>程序步[7].目标位置</td><td>0</td><td>0</td><td>0</td><td>-2147483647</td><td>2147483647</td></tr> <tr><td>178</td><td>程序块</td><td>program_block_step[7].Vtarget</td><td>程序步[7].目标速度</td><td>1</td><td>1</td><td>1</td><td>1</td><td>2147483647</td></tr> <tr><td>180</td><td>程序块</td><td>program_block_step[7].delay</td><td>程序步[7].延时</td><td>0</td><td>0</td><td>0</td><td>0</td><td>65535</td></tr> <tr><td>182</td><td>程序块</td><td>program_block_step[8].Xtarget</td><td>程序步[8].目标位置</td><td>0</td><td>0</td><td>0</td><td>-2147483647</td><td>2147483647</td></tr> <tr><td>184</td><td>程序块</td><td>program_block_step[8].Vtarget</td><td>程序步[8].目标速度</td><td>1</td><td>1</td><td>1</td><td>1</td><td>2147483647</td></tr> <tr><td>186</td><td>程序块</td><td>program_block_step[8].delay</td><td>程序步[8].延时</td><td>0</td><td>0</td><td>0</td><td>0</td><td>65535</td></tr> </tbody> </table>	参数号P	参数组	参数名	描述	设置值	当前值	出厂值	最小值	最大值	110	回零参数	homing_use_z_signal	z轴号辅助回零	1=开启	1=开启	1	0	1	112	回零参数	homing_velocity1	零点搜索速度1	60	60	60	1	6000	114	回零参数	homing_velocity2	零点搜索速度2	10	10	10	1	6000	116	回零参数	homing_torque_threshold	扭矩回零阈值	98	98	98	1	100	118	回零参数	homing_torque_time	扭矩阈值到达后延迟时间	10	10	10	1	65535	120	回零参数	home_offset	零点搜索完成后偏移距离	0	0	0	-2147483647	2147483647	122									124									126									128									130	点动参数	jog_velocity	JOG点动速度	60	60	60	1	80	132	点动参数	jog_increase_distance	JOG寸动距离	-2	-2	-2	-16	16	134	程序块参数	program_block_operation_mode	程序块运行模式	1=循环运行模式	1=循环运行模式	0	0	1	136	程序块参数	program_block_start_step	程序块起始步	1	1	1	1	16	138	程序块参数	program_block_end_step	程序块结束步	2	2	1	1	16	140	程序块	program_block_step[1].Xtarget	程序步[1].目标位置	0	0	0	-2147483647	2147483647	142	程序块	program_block_step[1].Vtarget	程序步[1].目标速度	5000	5000	1	1	2147483647	144	程序块	program_block_step[1].delay	程序步[1].延时	500	500	0	0	65535	146	程序块	program_block_step[2].Xtarget	程序步[2].目标位置	10000	10000	0	-2147483647	2147483647	148	程序块	program_block_step[2].Vtarget	程序步[2].目标速度	5000	5000	1	1	2147483647	150	程序块	program_block_step[2].delay	程序步[2].延时	500	500	0	0	65535	152	程序块	program_block_step[3].Xtarget	程序步[3].目标位置	0	0	0	-2147483647	2147483647	154	程序块	program_block_step[3].Vtarget	程序步[3].目标速度	1	1	1	1	2147483647	156	程序块	program_block_step[3].delay	程序步[3].延时	0	0	0	0	65535	158	程序块	program_block_step[4].Xtarget	程序步[4].目标位置	0	0	0	-2147483647	2147483647	160	程序块	program_block_step[4].Vtarget	程序步[4].目标速度	1	1	1	1	2147483647	162	程序块	program_block_step[4].delay	程序步[4].延时	0	0	0	0	65535	164	程序块	program_block_step[5].Xtarget	程序步[5].目标位置	0	0	0	-2147483647	2147483647	166	程序块	program_block_step[5].Vtarget	程序步[5].目标速度	1	1	1	1	2147483647	168	程序块	program_block_step[5].delay	程序步[5].延时	0	0	0	0	65535	170	程序块	program_block_step[6].Xtarget	程序步[6].目标位置	0	0	0	-2147483647	2147483647	172	程序块	program_block_step[6].Vtarget	程序步[6].目标速度	1	1	1	1	2147483647	174	程序块	program_block_step[6].delay	程序步[6].延时	0	0	0	0	65535	176	程序块	program_block_step[7].Xtarget	程序步[7].目标位置	0	0	0	-2147483647	2147483647	178	程序块	program_block_step[7].Vtarget	程序步[7].目标速度	1	1	1	1	2147483647	180	程序块	program_block_step[7].delay	程序步[7].延时	0	0	0	0	65535	182	程序块	program_block_step[8].Xtarget	程序步[8].目标位置	0	0	0	-2147483647	2147483647	184	程序块	program_block_step[8].Vtarget	程序步[8].目标速度	1	1	1	1	2147483647	186	程序块	program_block_step[8].delay	程序步[8].延时	0	0	0	0	65535
参数号P	参数组	参数名	描述	设置值	当前值	出厂值	最小值	最大值																																																																																																																																																																																																																																																																																																																																																																		
110	回零参数	homing_use_z_signal	z轴号辅助回零	1=开启	1=开启	1	0	1																																																																																																																																																																																																																																																																																																																																																																		
112	回零参数	homing_velocity1	零点搜索速度1	60	60	60	1	6000																																																																																																																																																																																																																																																																																																																																																																		
114	回零参数	homing_velocity2	零点搜索速度2	10	10	10	1	6000																																																																																																																																																																																																																																																																																																																																																																		
116	回零参数	homing_torque_threshold	扭矩回零阈值	98	98	98	1	100																																																																																																																																																																																																																																																																																																																																																																		
118	回零参数	homing_torque_time	扭矩阈值到达后延迟时间	10	10	10	1	65535																																																																																																																																																																																																																																																																																																																																																																		
120	回零参数	home_offset	零点搜索完成后偏移距离	0	0	0	-2147483647	2147483647																																																																																																																																																																																																																																																																																																																																																																		
122																																																																																																																																																																																																																																																																																																																																																																										
124																																																																																																																																																																																																																																																																																																																																																																										
126																																																																																																																																																																																																																																																																																																																																																																										
128																																																																																																																																																																																																																																																																																																																																																																										
130	点动参数	jog_velocity	JOG点动速度	60	60	60	1	80																																																																																																																																																																																																																																																																																																																																																																		
132	点动参数	jog_increase_distance	JOG寸动距离	-2	-2	-2	-16	16																																																																																																																																																																																																																																																																																																																																																																		
134	程序块参数	program_block_operation_mode	程序块运行模式	1=循环运行模式	1=循环运行模式	0	0	1																																																																																																																																																																																																																																																																																																																																																																		
136	程序块参数	program_block_start_step	程序块起始步	1	1	1	1	16																																																																																																																																																																																																																																																																																																																																																																		
138	程序块参数	program_block_end_step	程序块结束步	2	2	1	1	16																																																																																																																																																																																																																																																																																																																																																																		
140	程序块	program_block_step[1].Xtarget	程序步[1].目标位置	0	0	0	-2147483647	2147483647																																																																																																																																																																																																																																																																																																																																																																		
142	程序块	program_block_step[1].Vtarget	程序步[1].目标速度	5000	5000	1	1	2147483647																																																																																																																																																																																																																																																																																																																																																																		
144	程序块	program_block_step[1].delay	程序步[1].延时	500	500	0	0	65535																																																																																																																																																																																																																																																																																																																																																																		
146	程序块	program_block_step[2].Xtarget	程序步[2].目标位置	10000	10000	0	-2147483647	2147483647																																																																																																																																																																																																																																																																																																																																																																		
148	程序块	program_block_step[2].Vtarget	程序步[2].目标速度	5000	5000	1	1	2147483647																																																																																																																																																																																																																																																																																																																																																																		
150	程序块	program_block_step[2].delay	程序步[2].延时	500	500	0	0	65535																																																																																																																																																																																																																																																																																																																																																																		
152	程序块	program_block_step[3].Xtarget	程序步[3].目标位置	0	0	0	-2147483647	2147483647																																																																																																																																																																																																																																																																																																																																																																		
154	程序块	program_block_step[3].Vtarget	程序步[3].目标速度	1	1	1	1	2147483647																																																																																																																																																																																																																																																																																																																																																																		
156	程序块	program_block_step[3].delay	程序步[3].延时	0	0	0	0	65535																																																																																																																																																																																																																																																																																																																																																																		
158	程序块	program_block_step[4].Xtarget	程序步[4].目标位置	0	0	0	-2147483647	2147483647																																																																																																																																																																																																																																																																																																																																																																		
160	程序块	program_block_step[4].Vtarget	程序步[4].目标速度	1	1	1	1	2147483647																																																																																																																																																																																																																																																																																																																																																																		
162	程序块	program_block_step[4].delay	程序步[4].延时	0	0	0	0	65535																																																																																																																																																																																																																																																																																																																																																																		
164	程序块	program_block_step[5].Xtarget	程序步[5].目标位置	0	0	0	-2147483647	2147483647																																																																																																																																																																																																																																																																																																																																																																		
166	程序块	program_block_step[5].Vtarget	程序步[5].目标速度	1	1	1	1	2147483647																																																																																																																																																																																																																																																																																																																																																																		
168	程序块	program_block_step[5].delay	程序步[5].延时	0	0	0	0	65535																																																																																																																																																																																																																																																																																																																																																																		
170	程序块	program_block_step[6].Xtarget	程序步[6].目标位置	0	0	0	-2147483647	2147483647																																																																																																																																																																																																																																																																																																																																																																		
172	程序块	program_block_step[6].Vtarget	程序步[6].目标速度	1	1	1	1	2147483647																																																																																																																																																																																																																																																																																																																																																																		
174	程序块	program_block_step[6].delay	程序步[6].延时	0	0	0	0	65535																																																																																																																																																																																																																																																																																																																																																																		
176	程序块	program_block_step[7].Xtarget	程序步[7].目标位置	0	0	0	-2147483647	2147483647																																																																																																																																																																																																																																																																																																																																																																		
178	程序块	program_block_step[7].Vtarget	程序步[7].目标速度	1	1	1	1	2147483647																																																																																																																																																																																																																																																																																																																																																																		
180	程序块	program_block_step[7].delay	程序步[7].延时	0	0	0	0	65535																																																																																																																																																																																																																																																																																																																																																																		
182	程序块	program_block_step[8].Xtarget	程序步[8].目标位置	0	0	0	-2147483647	2147483647																																																																																																																																																																																																																																																																																																																																																																		
184	程序块	program_block_step[8].Vtarget	程序步[8].目标速度	1	1	1	1	2147483647																																																																																																																																																																																																																																																																																																																																																																		
186	程序块	program_block_step[8].delay	程序步[8].延时	0	0	0	0	65535																																																																																																																																																																																																																																																																																																																																																																		
2、切换运动模式至程序块模式。	将设备运动模式切换到点动模式并启用。	<p>运动模式 点动模式</p>																																																																																																																																																																																																																																																																																																																																																																								
3、Jog+按钮。	设备按照参数表设定的点动参数进行正方向运动。	<p>设定位置 10000 设置 当前位置 1</p> <p>设定速度 5000 设置 当前速度 -47</p> <p><input checked="" type="checkbox"/> Jog+ 当前负载 1</p> <p><input type="checkbox"/> Jog- 跟随误差 0</p> <p><input type="checkbox"/> 启动任务 <input checked="" type="checkbox"/> 暂停任务 <input checked="" type="checkbox"/> 取消任务 <input type="checkbox"/> 传输方式</p> <p><input type="checkbox"/> 确认错误 0=单步 1=连</p>																																																																																																																																																																																																																																																																																																																																																																								
4、Jog-按钮。	设备按照参数表设定的点动参数进行负方向运动。	<p><input checked="" type="checkbox"/> 使能 <input checked="" type="checkbox"/> 轴静止</p> <p><input type="checkbox"/> 斜坡位置到达 <input type="checkbox"/> 实际位置到达</p> <p><input checked="" type="checkbox"/> 斜坡速度到达 <input checked="" type="checkbox"/> 实际速度到达</p> <p><input type="checkbox"/> 正在回零 <input checked="" type="checkbox"/> 回零完成（零点已设置）</p>																																																																																																																																																																																																																																																																																																																																																																								

5.3.4.8 寸动模式

寸动模式																																																																																																																																																																																																																																																																																																																																																																										
步骤	作用	图示																																																																																																																																																																																																																																																																																																																																																																								
1、参数 jog_velocity = 60	设置点动速度为60rpm。(寸动速度=点动速度)	<p>参数表 波形录制</p> <table border="1"> <thead> <tr> <th>参数号P</th> <th>参数组</th> <th>参数名</th> <th>描述</th> <th>设置值</th> <th>当前值</th> <th>出厂值</th> <th>最小值</th> <th>最大值</th> </tr> </thead> <tbody> <tr><td>110</td><td>回零参数</td><td>homing_use_z_signal</td><td>Z信号辅助回零</td><td>1=开启</td><td>1=开启</td><td>1</td><td>0</td><td>1</td></tr> <tr><td>112</td><td>回零参数</td><td>homing_velocity1</td><td>零点搜索速度1</td><td>60</td><td>60</td><td>60</td><td>1</td><td>6000</td></tr> <tr><td>114</td><td>回零参数</td><td>homing_velocity2</td><td>零点搜索速度2</td><td>10</td><td>10</td><td>10</td><td>1</td><td>6000</td></tr> <tr><td>116</td><td>回零参数</td><td>homing_torque_threshold</td><td>扭矩回零阈值</td><td>98</td><td>98</td><td>98</td><td>1</td><td>100</td></tr> <tr><td>118</td><td>回零参数</td><td>homing_torque_time</td><td>扭矩回零到达延迟时间</td><td>10</td><td>10</td><td>10</td><td>1</td><td>65535</td></tr> <tr><td>120</td><td>回零参数</td><td>home_offset</td><td>零点搜索完成后偏移距离</td><td>0</td><td>0</td><td>0</td><td>-2147483647</td><td>2147483647</td></tr> <tr><td>122</td><td></td><td></td><td></td><td></td><td></td><td></td><td></td><td></td></tr> <tr><td>124</td><td></td><td></td><td></td><td></td><td></td><td></td><td></td><td></td></tr> <tr><td>126</td><td></td><td></td><td></td><td></td><td></td><td></td><td></td><td></td></tr> <tr><td>128</td><td></td><td></td><td></td><td></td><td></td><td></td><td></td><td></td></tr> <tr><td>130</td><td>点动参数</td><td>jog_velocity</td><td>JOG点动速度</td><td>60</td><td>60</td><td>60</td><td>1</td><td>6000</td></tr> <tr><td>132</td><td>点动参数</td><td>jog_increase_distance</td><td>JOG寸动距离</td><td>-2</td><td>-2</td><td>2</td><td>16</td><td>1</td></tr> <tr><td>134</td><td>程序块参数</td><td>program_block_operation_mode</td><td>程序块运行模式</td><td>1=循环运行模式</td><td>1=循环运行模式</td><td>0</td><td>0</td><td>1</td></tr> <tr><td>136</td><td>程序块参数</td><td>program_block_start_step</td><td>程序块起始步</td><td>1</td><td>1</td><td>1</td><td>1</td><td>16</td></tr> <tr><td>138</td><td>程序块参数</td><td>program_block_end_step</td><td>程序块结束步</td><td>2</td><td>2</td><td>1</td><td>1</td><td>16</td></tr> <tr><td>140</td><td>程序块</td><td>program_block_step[1].Xtarget</td><td>程序步[1] 目标位置</td><td>0</td><td>0</td><td>0</td><td>-2147483647</td><td>2147483647</td></tr> <tr><td>142</td><td>程序块</td><td>program_block_step[1].Vtarget</td><td>程序步[1] 目标速度</td><td>5000</td><td>5000</td><td>1</td><td>1</td><td>2147483647</td></tr> <tr><td>144</td><td>程序块</td><td>program_block_step[1].delay</td><td>程序步[1] 延时</td><td>500</td><td>500</td><td>0</td><td>0</td><td>65535</td></tr> <tr><td>146</td><td>程序块</td><td>program_block_step[2].Xtarget</td><td>程序步[2] 目标位置</td><td>10000</td><td>10000</td><td>0</td><td>-2147483647</td><td>2147483647</td></tr> <tr><td>148</td><td>程序块</td><td>program_block_step[2].Vtarget</td><td>程序步[2] 目标速度</td><td>5000</td><td>5000</td><td>1</td><td>1</td><td>2147483647</td></tr> <tr><td>150</td><td>程序块</td><td>program_block_step[2].delay</td><td>程序步[2] 延时</td><td>500</td><td>500</td><td>0</td><td>0</td><td>65535</td></tr> <tr><td>152</td><td>程序块</td><td>program_block_step[3].Xtarget</td><td>程序步[3] 目标位置</td><td>0</td><td>0</td><td>0</td><td>-2147483647</td><td>2147483647</td></tr> <tr><td>154</td><td>程序块</td><td>program_block_step[3].Vtarget</td><td>程序步[3] 目标速度</td><td>1</td><td>1</td><td>1</td><td>1</td><td>2147483647</td></tr> <tr><td>156</td><td>程序块</td><td>program_block_step[3].delay</td><td>程序步[3] 延时</td><td>0</td><td>0</td><td>0</td><td>0</td><td>65535</td></tr> <tr><td>158</td><td>程序块</td><td>program_block_step[4].Xtarget</td><td>程序步[4] 目标位置</td><td>0</td><td>0</td><td>0</td><td>-2147483647</td><td>2147483647</td></tr> <tr><td>160</td><td>程序块</td><td>program_block_step[4].Vtarget</td><td>程序步[4] 目标速度</td><td>1</td><td>1</td><td>1</td><td>1</td><td>2147483647</td></tr> <tr><td>162</td><td>程序块</td><td>program_block_step[4].delay</td><td>程序步[4] 延时</td><td>0</td><td>0</td><td>0</td><td>0</td><td>65535</td></tr> <tr><td>164</td><td>程序块</td><td>program_block_step[5].Xtarget</td><td>程序步[5] 目标位置</td><td>0</td><td>0</td><td>0</td><td>-2147483647</td><td>2147483647</td></tr> <tr><td>166</td><td>程序块</td><td>program_block_step[5].Vtarget</td><td>程序步[5] 目标速度</td><td>1</td><td>1</td><td>1</td><td>1</td><td>2147483647</td></tr> <tr><td>168</td><td>程序块</td><td>program_block_step[5].delay</td><td>程序步[5] 延时</td><td>0</td><td>0</td><td>0</td><td>0</td><td>65535</td></tr> <tr><td>170</td><td>程序块</td><td>program_block_step[6].Xtarget</td><td>程序步[6] 目标位置</td><td>0</td><td>0</td><td>0</td><td>-2147483647</td><td>2147483647</td></tr> <tr><td>172</td><td>程序块</td><td>program_block_step[6].Vtarget</td><td>程序步[6] 目标速度</td><td>1</td><td>1</td><td>1</td><td>1</td><td>2147483647</td></tr> <tr><td>174</td><td>程序块</td><td>program_block_step[6].delay</td><td>程序步[6] 延时</td><td>0</td><td>0</td><td>0</td><td>0</td><td>65535</td></tr> <tr><td>176</td><td>程序块</td><td>program_block_step[7].Xtarget</td><td>程序步[7] 目标位置</td><td>0</td><td>0</td><td>0</td><td>-2147483647</td><td>2147483647</td></tr> <tr><td>178</td><td>程序块</td><td>program_block_step[7].Vtarget</td><td>程序步[7] 目标速度</td><td>1</td><td>1</td><td>1</td><td>1</td><td>2147483647</td></tr> <tr><td>180</td><td>程序块</td><td>program_block_step[7].delay</td><td>程序步[7] 延时</td><td>0</td><td>0</td><td>0</td><td>0</td><td>65535</td></tr> <tr><td>182</td><td>程序块</td><td>program_block_step[8].Xtarget</td><td>程序步[8] 目标位置</td><td>0</td><td>0</td><td>0</td><td>-2147483647</td><td>2147483647</td></tr> <tr><td>184</td><td>程序块</td><td>program_block_step[8].Vtarget</td><td>程序步[8] 目标速度</td><td>1</td><td>1</td><td>1</td><td>1</td><td>2147483647</td></tr> <tr><td>186</td><td>程序块</td><td>program_block_step[8].delay</td><td>程序步[8] 延时</td><td>0</td><td>0</td><td>0</td><td>0</td><td>65535</td></tr> </tbody> </table>	参数号P	参数组	参数名	描述	设置值	当前值	出厂值	最小值	最大值	110	回零参数	homing_use_z_signal	Z信号辅助回零	1=开启	1=开启	1	0	1	112	回零参数	homing_velocity1	零点搜索速度1	60	60	60	1	6000	114	回零参数	homing_velocity2	零点搜索速度2	10	10	10	1	6000	116	回零参数	homing_torque_threshold	扭矩回零阈值	98	98	98	1	100	118	回零参数	homing_torque_time	扭矩回零到达延迟时间	10	10	10	1	65535	120	回零参数	home_offset	零点搜索完成后偏移距离	0	0	0	-2147483647	2147483647	122									124									126									128									130	点动参数	jog_velocity	JOG点动速度	60	60	60	1	6000	132	点动参数	jog_increase_distance	JOG寸动距离	-2	-2	2	16	1	134	程序块参数	program_block_operation_mode	程序块运行模式	1=循环运行模式	1=循环运行模式	0	0	1	136	程序块参数	program_block_start_step	程序块起始步	1	1	1	1	16	138	程序块参数	program_block_end_step	程序块结束步	2	2	1	1	16	140	程序块	program_block_step[1].Xtarget	程序步[1] 目标位置	0	0	0	-2147483647	2147483647	142	程序块	program_block_step[1].Vtarget	程序步[1] 目标速度	5000	5000	1	1	2147483647	144	程序块	program_block_step[1].delay	程序步[1] 延时	500	500	0	0	65535	146	程序块	program_block_step[2].Xtarget	程序步[2] 目标位置	10000	10000	0	-2147483647	2147483647	148	程序块	program_block_step[2].Vtarget	程序步[2] 目标速度	5000	5000	1	1	2147483647	150	程序块	program_block_step[2].delay	程序步[2] 延时	500	500	0	0	65535	152	程序块	program_block_step[3].Xtarget	程序步[3] 目标位置	0	0	0	-2147483647	2147483647	154	程序块	program_block_step[3].Vtarget	程序步[3] 目标速度	1	1	1	1	2147483647	156	程序块	program_block_step[3].delay	程序步[3] 延时	0	0	0	0	65535	158	程序块	program_block_step[4].Xtarget	程序步[4] 目标位置	0	0	0	-2147483647	2147483647	160	程序块	program_block_step[4].Vtarget	程序步[4] 目标速度	1	1	1	1	2147483647	162	程序块	program_block_step[4].delay	程序步[4] 延时	0	0	0	0	65535	164	程序块	program_block_step[5].Xtarget	程序步[5] 目标位置	0	0	0	-2147483647	2147483647	166	程序块	program_block_step[5].Vtarget	程序步[5] 目标速度	1	1	1	1	2147483647	168	程序块	program_block_step[5].delay	程序步[5] 延时	0	0	0	0	65535	170	程序块	program_block_step[6].Xtarget	程序步[6] 目标位置	0	0	0	-2147483647	2147483647	172	程序块	program_block_step[6].Vtarget	程序步[6] 目标速度	1	1	1	1	2147483647	174	程序块	program_block_step[6].delay	程序步[6] 延时	0	0	0	0	65535	176	程序块	program_block_step[7].Xtarget	程序步[7] 目标位置	0	0	0	-2147483647	2147483647	178	程序块	program_block_step[7].Vtarget	程序步[7] 目标速度	1	1	1	1	2147483647	180	程序块	program_block_step[7].delay	程序步[7] 延时	0	0	0	0	65535	182	程序块	program_block_step[8].Xtarget	程序步[8] 目标位置	0	0	0	-2147483647	2147483647	184	程序块	program_block_step[8].Vtarget	程序步[8] 目标速度	1	1	1	1	2147483647	186	程序块	program_block_step[8].delay	程序步[8] 延时	0	0	0	0	65535
参数号P	参数组	参数名	描述	设置值	当前值	出厂值	最小值	最大值																																																																																																																																																																																																																																																																																																																																																																		
110	回零参数	homing_use_z_signal	Z信号辅助回零	1=开启	1=开启	1	0	1																																																																																																																																																																																																																																																																																																																																																																		
112	回零参数	homing_velocity1	零点搜索速度1	60	60	60	1	6000																																																																																																																																																																																																																																																																																																																																																																		
114	回零参数	homing_velocity2	零点搜索速度2	10	10	10	1	6000																																																																																																																																																																																																																																																																																																																																																																		
116	回零参数	homing_torque_threshold	扭矩回零阈值	98	98	98	1	100																																																																																																																																																																																																																																																																																																																																																																		
118	回零参数	homing_torque_time	扭矩回零到达延迟时间	10	10	10	1	65535																																																																																																																																																																																																																																																																																																																																																																		
120	回零参数	home_offset	零点搜索完成后偏移距离	0	0	0	-2147483647	2147483647																																																																																																																																																																																																																																																																																																																																																																		
122																																																																																																																																																																																																																																																																																																																																																																										
124																																																																																																																																																																																																																																																																																																																																																																										
126																																																																																																																																																																																																																																																																																																																																																																										
128																																																																																																																																																																																																																																																																																																																																																																										
130	点动参数	jog_velocity	JOG点动速度	60	60	60	1	6000																																																																																																																																																																																																																																																																																																																																																																		
132	点动参数	jog_increase_distance	JOG寸动距离	-2	-2	2	16	1																																																																																																																																																																																																																																																																																																																																																																		
134	程序块参数	program_block_operation_mode	程序块运行模式	1=循环运行模式	1=循环运行模式	0	0	1																																																																																																																																																																																																																																																																																																																																																																		
136	程序块参数	program_block_start_step	程序块起始步	1	1	1	1	16																																																																																																																																																																																																																																																																																																																																																																		
138	程序块参数	program_block_end_step	程序块结束步	2	2	1	1	16																																																																																																																																																																																																																																																																																																																																																																		
140	程序块	program_block_step[1].Xtarget	程序步[1] 目标位置	0	0	0	-2147483647	2147483647																																																																																																																																																																																																																																																																																																																																																																		
142	程序块	program_block_step[1].Vtarget	程序步[1] 目标速度	5000	5000	1	1	2147483647																																																																																																																																																																																																																																																																																																																																																																		
144	程序块	program_block_step[1].delay	程序步[1] 延时	500	500	0	0	65535																																																																																																																																																																																																																																																																																																																																																																		
146	程序块	program_block_step[2].Xtarget	程序步[2] 目标位置	10000	10000	0	-2147483647	2147483647																																																																																																																																																																																																																																																																																																																																																																		
148	程序块	program_block_step[2].Vtarget	程序步[2] 目标速度	5000	5000	1	1	2147483647																																																																																																																																																																																																																																																																																																																																																																		
150	程序块	program_block_step[2].delay	程序步[2] 延时	500	500	0	0	65535																																																																																																																																																																																																																																																																																																																																																																		
152	程序块	program_block_step[3].Xtarget	程序步[3] 目标位置	0	0	0	-2147483647	2147483647																																																																																																																																																																																																																																																																																																																																																																		
154	程序块	program_block_step[3].Vtarget	程序步[3] 目标速度	1	1	1	1	2147483647																																																																																																																																																																																																																																																																																																																																																																		
156	程序块	program_block_step[3].delay	程序步[3] 延时	0	0	0	0	65535																																																																																																																																																																																																																																																																																																																																																																		
158	程序块	program_block_step[4].Xtarget	程序步[4] 目标位置	0	0	0	-2147483647	2147483647																																																																																																																																																																																																																																																																																																																																																																		
160	程序块	program_block_step[4].Vtarget	程序步[4] 目标速度	1	1	1	1	2147483647																																																																																																																																																																																																																																																																																																																																																																		
162	程序块	program_block_step[4].delay	程序步[4] 延时	0	0	0	0	65535																																																																																																																																																																																																																																																																																																																																																																		
164	程序块	program_block_step[5].Xtarget	程序步[5] 目标位置	0	0	0	-2147483647	2147483647																																																																																																																																																																																																																																																																																																																																																																		
166	程序块	program_block_step[5].Vtarget	程序步[5] 目标速度	1	1	1	1	2147483647																																																																																																																																																																																																																																																																																																																																																																		
168	程序块	program_block_step[5].delay	程序步[5] 延时	0	0	0	0	65535																																																																																																																																																																																																																																																																																																																																																																		
170	程序块	program_block_step[6].Xtarget	程序步[6] 目标位置	0	0	0	-2147483647	2147483647																																																																																																																																																																																																																																																																																																																																																																		
172	程序块	program_block_step[6].Vtarget	程序步[6] 目标速度	1	1	1	1	2147483647																																																																																																																																																																																																																																																																																																																																																																		
174	程序块	program_block_step[6].delay	程序步[6] 延时	0	0	0	0	65535																																																																																																																																																																																																																																																																																																																																																																		
176	程序块	program_block_step[7].Xtarget	程序步[7] 目标位置	0	0	0	-2147483647	2147483647																																																																																																																																																																																																																																																																																																																																																																		
178	程序块	program_block_step[7].Vtarget	程序步[7] 目标速度	1	1	1	1	2147483647																																																																																																																																																																																																																																																																																																																																																																		
180	程序块	program_block_step[7].delay	程序步[7] 延时	0	0	0	0	65535																																																																																																																																																																																																																																																																																																																																																																		
182	程序块	program_block_step[8].Xtarget	程序步[8] 目标位置	0	0	0	-2147483647	2147483647																																																																																																																																																																																																																																																																																																																																																																		
184	程序块	program_block_step[8].Vtarget	程序步[8] 目标速度	1	1	1	1	2147483647																																																																																																																																																																																																																																																																																																																																																																		
186	程序块	program_block_step[8].delay	程序步[8] 延时	0	0	0	0	65535																																																																																																																																																																																																																																																																																																																																																																		
3、切换运动模式至程序块模式。	将设备运动模式切换到寸动模式并使其能。	<p>运动模式 寸动模式 3</p>																																																																																																																																																																																																																																																																																																																																																																								
4、Jog+按钮。	设备按照参数表设定的寸动参数进行正方向运动。	<p>设定位置 10000 设置 当前位置 0</p> <p>设定速度 5000 设置 当前速度 -73</p> <p>当前负载 2</p> <p><input checked="" type="checkbox"/> Jog+ 4</p> <p>跟随误差 0</p>																																																																																																																																																																																																																																																																																																																																																																								
5、Jog-按钮。	设备按照参数表设定的寸动参数进行负方向运动。	<p><input type="checkbox"/> Jog- 5</p> <p><input type="checkbox"/> 启动任务 <input checked="" type="checkbox"/> 暂停任务 <input checked="" type="checkbox"/> 取消任务 <input type="checkbox"/> 传输方式</p> <p><input type="checkbox"/> 确认错误</p> <p>0=单步 1=连</p> <p><input checked="" type="checkbox"/> 使能 <input checked="" type="checkbox"/> 轴静止</p> <p><input type="checkbox"/> 斜坡位置到达 <input type="checkbox"/> 实际位置到达</p> <p><input checked="" type="checkbox"/> 斜坡速度到达 <input checked="" type="checkbox"/> 实际速度到达</p> <p><input type="checkbox"/> 正在回零 <input checked="" type="checkbox"/> 回零完成(零点已设置)</p>																																																																																																																																																																																																																																																																																																																																																																								

5.3.5 波形录制

波形录制		
步骤	作用	图示
1、切换波形录制	打开波形录制操作界面	
2、切换运动模式至程序块模式。	将设备运动模式切换到点动模式并使能。	
3、点击录制按钮	确定相对位置移动的距离和速度。	
4、按下 JOG+	设备按照参数表设定的点动参数进行正方向运动。	
5、查看波形	查看录制的波形。	

说明：长按鼠标左键并拖动可调整显示区 X 轴显示范围，鼠标滚轮可将波形图像放大或者缩小。
 软件界面功能可查看[调试窗口](#)章节

6 功能

6.1 转矩限制

P10 [calibration_mode_torque_limit] [校准模式转矩限制]

用于限制校准模式下控制器的最大允许输出转矩。通过设置校准转矩，可以避免在校准过程中电机出现抖动或其他不稳定现象，确保电机在校准模式下的安全运行。（仅厂家使用此参数）

P12 [normal_mode_torque_limit] [常规模式转矩限制]

用于限制常规模式下控制器的最大允许输出转矩，以确保电机在各种运动模式下的安全运行。

常规模式包括：增量位置模式、绝对位置模式、速度模式、主动回零模式、零点设置模式、程序块模式、点动模式和寸动模式。

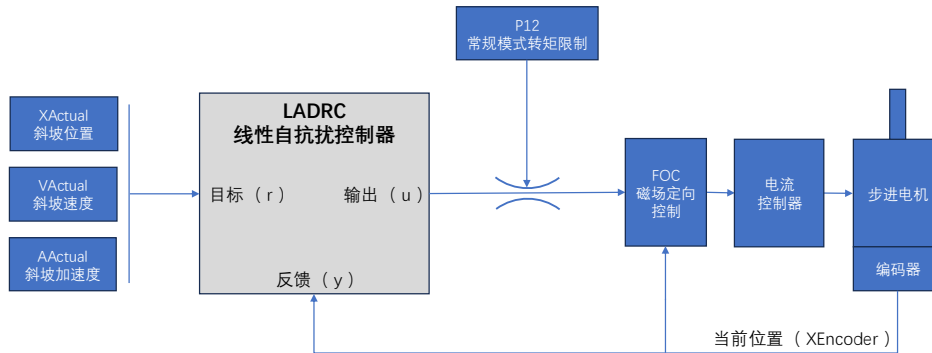

示例配置

假设我们设置了以下参数：

- P12 [normal_mode_torque_limit] [常规模式转矩限制]: 设置为 70%。

这意味着：

- 闭环控制器输出的控制量，被限制在 -70% 至 +70% 的范围内。

6.2 斜坡函数发生器

斜坡函数发生器用于生成平滑的运动轨迹，以避免启停时产生机械冲击和过载。

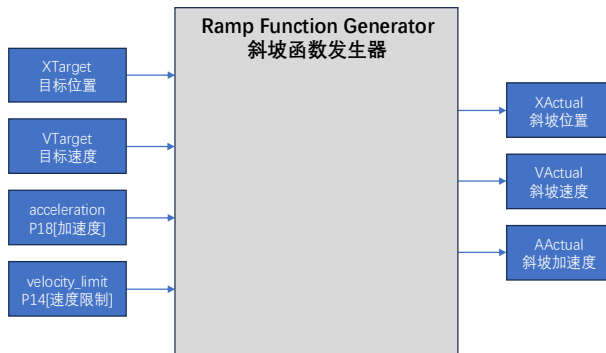

斜坡函数发生器的特性如图所示：

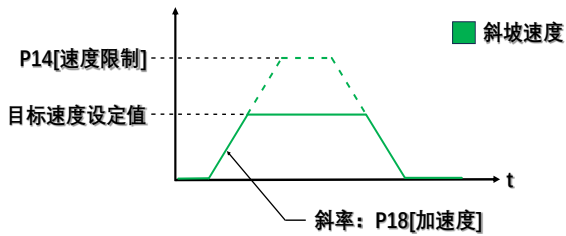

P14 [velocity_limit] [速度限制]

用于限制目标速度设定值的最大范围，以防止过大的速度设定值导致机械结构损坏。

P16 [acceleration_limit] [加速度限制]

限制加速度设定值的最大允许值，以防止过大的加速度设定值导致机械结构损坏。

P18 [acceleraton] [加速度]

用于设置加速度。在运动的过程当中允许实时修改加速度，合理的加速度可以改善系统的稳定性和机械寿命。

6.3 设置机械系统

通过设置机械参数，可以建立电机轴和机械运动部件之间的联系，确保电机控制符合实际机械系统的特性。这包括设置负载每圈的单位数（LU 数）和齿轮比。

P20 [lu] [负载每圈 LU 数]

LU 是 Length Unit 的缩写，用于设置负载轴每转一圈，机械运动部件移动的单位数。相当于“负载每圈脉冲数”。

P22 [gear_ratio_n1] [齿轮比 n1]

减速机电机侧转数

P24 [gear_ratio_n2] [齿轮比 n2]

减速机负载侧转数。

减速比的定义为 $n1 : n2$ 。

当减速比带有小数时，可以将减速比同比放大后再进行设置，以确保数值便于处理。

配置示例

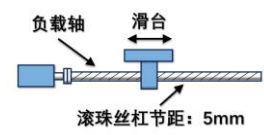
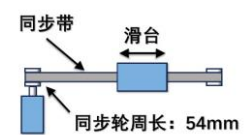
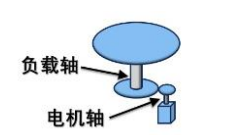
步骤	描述	机构类型		
		滚珠丝杠	同步带	转台
				
1	识别机械系统	<ul style="list-style-type: none"> 滚珠丝杠节距：5mm 减速齿轮比：1: 1 	<ul style="list-style-type: none"> 同步轮周长：54mm 减速齿轮比：1: 1 	<ul style="list-style-type: none"> 旋转角度：360 减速齿轮比：3.175: 1
2	定义LU	1 LU = 1 μm	1 LU = 1 μm	1 LU = 0.01 °
3	计算负载轴每转的LU	5/0.001 = 5000 LU	54/0.001 = 54000 LU	360/0.01 = 36000 LU
4	设置参数	<ul style="list-style-type: none"> 负载每圈LU数：5000 齿轮比n1：1 齿轮比n2：1 	<ul style="list-style-type: none"> 负载每圈LU数：54000 齿轮比n1：1 齿轮比n2：1 	<ul style="list-style-type: none"> 负载每圈LU数：36000 齿轮比n1：3175 齿轮比n2：1000

6.4 速度滤波器

P26 [velocity_lpf_exp] [速度滤波指数]

速度滤波指数是用于控制速度反馈信号平滑程度的一个关键参数。通过设置速度滤波指数，可以调整速度反馈信号的平滑程度，从而影响速度到达标志和电机静止标志的判断。

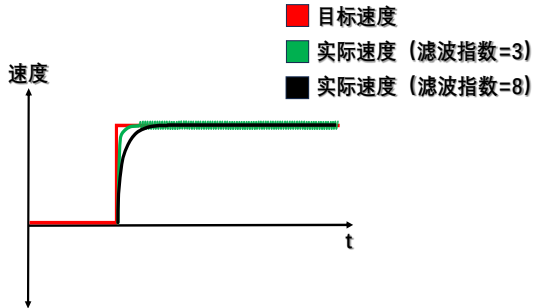

参数说明

- **设定值:** 定义了速度反馈信号的平滑程度。
- **设定值越大:** 速度反馈越平滑，但响应速度会变慢。
- **设定值越小:** 速度反馈波动较大，但响应速度较快。

注意事项

- 如果速度反馈过于平滑，可能会延迟速度到达标志或电机静止标志的判断。
- 如果速度反馈波动较大，可能会导致速度到达标志或电机静止标志的误判。

示例配置

假设我们设置了以下参数：

- **P26 [velocity_lpf_exp]:** 设置为 8。

这意味着：

- 数值 8 表示速度反馈信号较为平滑，响应速度相对较慢。

6.5 电机旋转方向

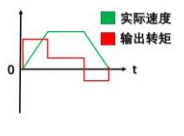
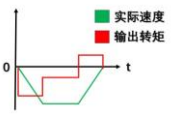
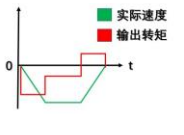
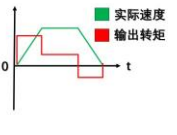
参数	参数值	描述	设定值	
			正转	反转
P28	0	不取反 (正转为顺时针)		
	1	取反 (正转为逆时针)		

P28 [invert_direction] [取反运动方向]

如果电机的实际旋转方向与所需的运动方向相反，可以通过设置此参数来反转方向。

设定值	备注
0	不取反运动方向
1	取反运动方向

注意事项

- 该参数设置后下次使能生效，生效后清除零点，需要重新执行主动回零点操作。

6.6 闭环控制器

设备的闭环控制由 LADRC（线性自抗扰控制器）实现。LADRC 是一种现代控制策略，它特别适用于需要克服模型不确定性和外部扰动的系统。其核心在于能够实时估计和补偿系统中的扰动，从而提高系统的稳定性和响应性能。

LADRC 主要由两个部分组成：LESO（线性扩展状态观测器）和 LSEF（线性状态误差反馈控制器）。

技术原理

LESO（线性扩展状态观测器）：LESO 能够实时估计系统的位置、速度及总扰动，为后续的控制提供准确的信息。

LSEF（线性状态误差反馈控制器）：使用状态误差来生成控制器输出，通过 LESO 提供的总扰动估计值实时抵消扰动的影响，确保系统能够准确跟随设定值。

特点与优势

鲁棒性强：能够有效应对模型不确定性及外部扰动，如在电机应用中的负载扰动，控制器能够实时将其补偿。

易于使用：相较于传统内外环结构的 PID 控制器，使用 LADRC 参数调节更为简单直观，仅需调节两个参数即可满足大部分应用场景。

广泛适用性：适用于多种应用场景，如工业过程控制、机器人控制、电力电子等领域。

LADRC 控制器结构图

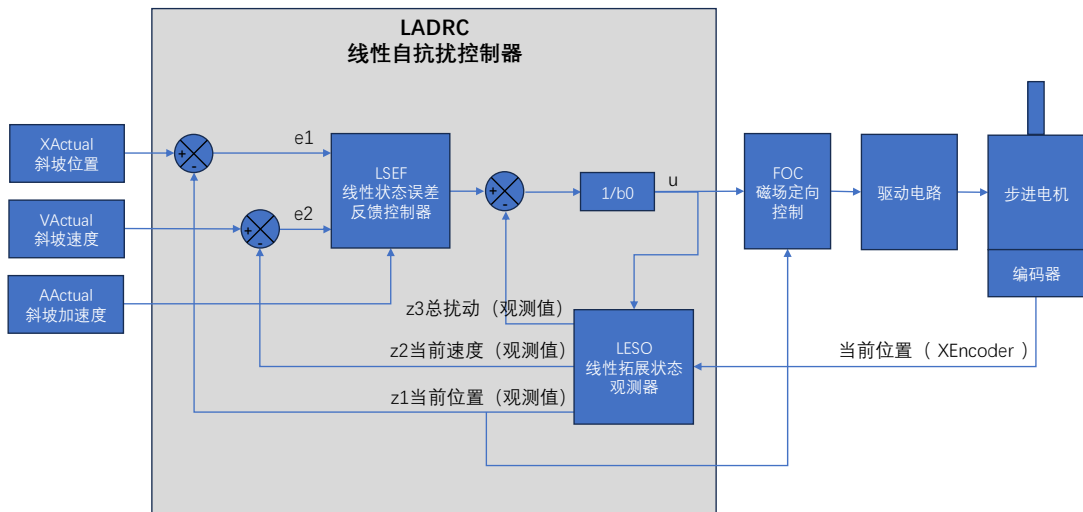

6.6.1 主要参数

P36 [ladrc_bandwidth] [LADRC 带宽]

LADRC 的带宽设置, LSEF 带宽 (ω_c) = 1 * ladrc_bandwidth, LESO 带宽 (ω_o) = 5 * ladrc_bandwidth。

较高的带宽可以使电机动态响应更快, 但可能导致系统振荡; 较小的带宽则会导致电机动态响应较慢, 但系统更稳定。在满足动态性能的情况下应该选择尽可能小的带宽。

P38 [ladrc_b0] [LADRC 被控系统系数]

b0 为被控系统的状态方程 $\dot{x} = Ax + Bu$ 中系数 B 的一个估计值, 系数 B 反映了系统的特性增益, 此系数受惯量和摩擦力影响。b0 需要根据电机带的负载大小来取值。

6.6.2 调优参数

当电机动态性能未达到预期时, 可以通过调节以下参数进行优化。

P34 [controller_preferences] [控制器偏好]

控制器动态性能的偏好设置。

设定值越小, 位置跟随精度越高;

设定值越大, 速度跟随精度越高;

P40 [torque_ffw] [转矩前馈]

转矩前馈 (torque_ffw) 用于改善伺服系统的动态性能, 可提高系统的响应速度和准确性, 过大的设置值会使位置控制系统超调。转矩前馈比例越大, 加速或减速时的前馈补偿量越大。

P42 [dynamic_bandwidth_enable] [LADRC 动态带宽使能]

开启或关闭 LADRC 动态带宽功能。

设定值	备注
0	关闭 LADRC 动态带宽功能
1	开启 LADRC 动态带宽功能

P44 [dynamic_bandwidth] [LADRC 动态带宽]

LADRC 动态带宽功能

动态带宽功能启用后, 允许控制器根据当前的运动状态自动切换带宽, 以达到最佳的控制效果。

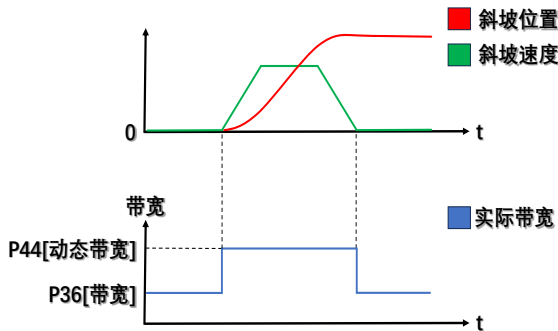

当静止时, 控制器使用 P36 [LADRC 带宽] 所设定的带宽值; 当运动时, 控制器使用 P44 [LADRC 动态带宽] 所设定的带宽值。

配置建议

宽动态应用: 建议 P44 [LADRC 动态带宽] 的设定值比 P36 [LADRC 带宽] 的设定值大 1.5 倍至 2 倍, 当电机处于静止状态下时, 使用较低带宽以保证系统的稳定性; 而电机处于运动状态下时, 则可以采用较高的带宽来提高响应速度。

6.7 弱磁控制

弱磁控制主要用于扩展电机的工作速度范围。通过降低电机的磁通量（即降低励磁电流），可以降低电机的反电动势，从而使电机能够在更高转速下运行。

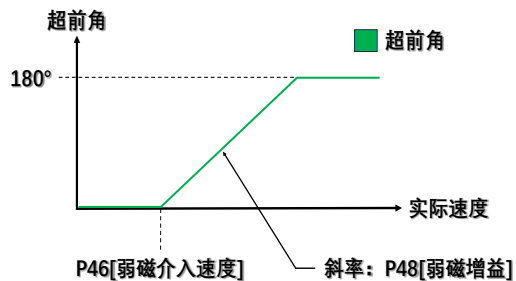

P46 [fw_velocity] [弱磁介入速度]

开始应用弱磁控制的转速阈值，当电机的转速达到或超过此设定值时，弱磁控制开始介入。

一般为 200RPM-400RPM 开始弱磁。

配置建议

- 根据电机的特性和应用需求来设定此参数。

P48 [fw_gain] [弱磁增益]

控制弱磁控制的强度。较大的值意味着较弱的增益，较小的值意味着较强的增益。

配置建议

- 根据电机的特性和应用需求来设定此参数。

6.8 电流控制器

6.8.1 MD42 系列

电流控制器用于实时跟随电流设定值，MD42 系列使用滞环控制器实现电流控制。电流控制器参数需综合考虑系统动态需求、硬件特性及工况变化。

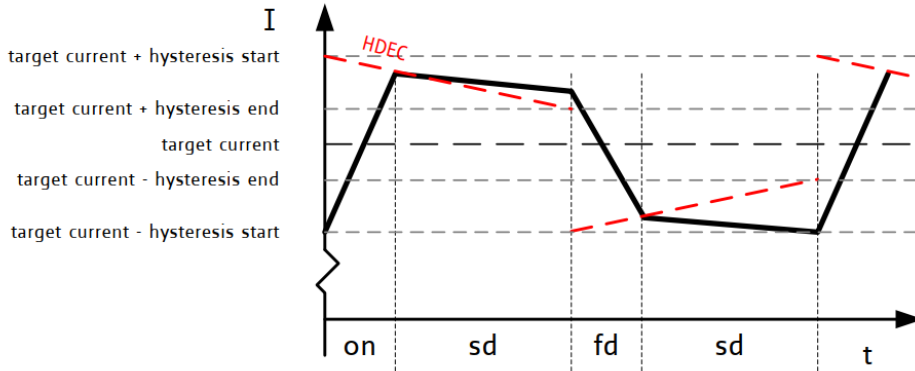

on 为绕组充电段 sd 为慢衰减段 fd 为快衰减段

滞环控制原理

通过快速切换功率开关，实现对电机绕组电流的精确控制。

完整的控制周期分为四个阶段：绕组充电（on）、慢衰减 1（slow decay）、快衰减（fast decay）和慢衰减 2（slow decay）。

- **绕组充电**：在这个阶段，电机绕组中的电流迅速上升，直到电流高于 目标电流+迟滞阈值 后进入下一阶段。
- **慢衰减 1**：在这个阶段，电机绕组中的电流缓慢下降，维持 toff 时间后进入下一阶段。
- **快衰减**：在这个阶段，电机绕组中的电流迅速下降，直到电流低于 目标电流-迟滞阈值 后进入下一阶段。
- **慢衰减 2**：在这个阶段，电机绕组中的电流缓慢下降，维持 toff 时间后完成控制周期，并开始下个控制周期。

迟滞阈值

电流控制器会根据电流的偏差调整驱动信号，以保持电流在一个稳定的范围内。然而，在某些情况下，如绕组电阻较高时，斩波频率可能会变得过低，这可能导致噪音问题。

HDEC（Hysteresis Decrementer）用于自动调节迟滞阈值，以保持开关频率合理，特别是在高电流幅值和低供电电压的情况下，可以避免开关频率进入可听范围，减少噪音。

HDEC 通过以下方式工作：

- **迟滞阈值的开始值和结束值设置：**
 - **HSTRT (Hysteresis Start)**：迟滞阈值的开始值。
 - **HEND (Hysteresis End)**：迟滞阈值的结束值。
- **自动递减**：在每个斩波周期开始时，迟滞阈值初始化为 **HSTRT + HEND** 的和。然后，随着斩波周期的进行，迟滞阈值会逐步递减，直到斩波频率合适的迟滞阈值或 **HEND** 值为止。
- **16 系统时钟的递减**：每隔 16 个系统时钟周期，迟滞阈值就会递减一步。

P50 [chopper_toff] [电流控制器慢衰减时间]

电流控制器的慢衰减(slow decay)时间。慢衰减时间的设置影响着电流控制器如何控制电机绕组中的电流下降速率。

较长的慢衰减时间可以减少电流波动，但可能会降低系统的响应速度。

较短的慢衰减时间可以提高响应速度，但可能会导致电流波动和 EMI 噪声增加。

配置建议

- **低噪声应用**：如果需要减少 EMI 电磁噪声，可以选择较长的慢衰减时间（如设定值 4）。
- **快速响应应用**：如果需要提高系统的响应速度，可以选择较短的慢衰减时间（如设定值 2）。

设定值	备注
-----	----

2	TOFF = 6.67 us
3 (默认值)	TOFF = 9.09 us
4	TOFF = 11.52 us

P52 [chopper_hstrt] [电流控制器迟滞窗口上限]

电流控制器的迟滞阈值上限 (hysteresis start)。

配置建议

- **低噪声应用:** 如果需要减少 EMI 噪声影响, 可以选择较大的迟滞窗口大小 (即较大的 HSTRT 和较大的 HEND 值)。
- **快速响应应用:** 如果需要提高系统的响应速度, 可以选择较小的迟滞窗口大小 (即较小的 HSTRT 和较小的 HEND 值)。

设定值	备注
0	HSTRT = 1
1	HSTRT = 2
2 (默认值)	HSTRT = 3
3	HSTRT = 4
4	HSTRT = 5
5	HSTRT = 6
6	HSTRT = 7
7	HSTRT = 8

P54 [chopper_hend] [电流控制器迟滞窗口下限]

电流控制器的迟滞阈值下限 (hysteresis end)。

配置建议

- **低噪声应用:** 如果需要减少 EMI 噪声影响, 可以选择较大的迟滞窗口大小 (即较大的 HSTRT 和较大的 HEND 值)。
- **快速响应应用:** 如果需要提高系统的响应速度, 可以选择较小的迟滞窗口大小 (即较小的 HSTRT 和较小的 HEND 值)。

设定值	备注
0	HEND = -3
1	HEND = -2
2	HEND = -1
3	HEND = 0
4 (默认值)	HEND = 1
5	HEND = 2
6	HEND = 3
7	HEND = 4
8	HEND = 5
9	HEND = 6

10	HEND = 7
11	HEND = 8

P56 [chopper_tbl] [电流控制器电流采样消隐时间]

电流采样期间的消隐时间。

电流控制器需要定期采样电机绕组中的电流以调整驱动信号，而电流采样消隐时间是指在电流采样过程中，电机驱动器不会更新驱动信号的时间段。这段时间内，驱动信号保持不变，以避免在采样期间引入额外的噪声或不稳定因素。

配置建议

- **低噪声应用**：如果需要减少 EMI 噪声影响，可以选择较长的消隐时间（如设定值 3）。
- **快速响应应用**：如果需要提高系统的响应速度，可以选择较短的消隐时间（如设定值 0）。

设定值	备注
0	TBL = 1.2 us
1	TBL = 1.8 us
2（默认值）	TBL = 2.7 us
3	TBL = 4.1 us

P58 [current_derate] [电流降额]

设备在出厂时已录入电机的额定电流信息，为了避免用户修改电流时误操作导致电机过流损坏，使用电流降额百分比的方式来对电流参数进行设置。

电流降额 参数用于按百分比降低最大输出电流。用于在不同工况下调整电机的最大电流输出，以适应不同的负载需求或者为了保护电机不受过热损害。

此参数在校准模式和常规模式下均有效。

应用场景

- **负载变化**：如果电机在不同的负载条件下运行时出现共振现象，可调整最大电流输出以降低振幅。
- **温度管理**：在高温环境下运行电机时，可以通过降低电流输出来减少发热，从而避免过热。

配置建议

- 如果电机经常运行在满载状态并且没有出现过热问题，可以将此参数设置为 0，以充分利用电机的全部输出能力。
- 如果电机在不同的负载条件下运行时出现共振现象，可以根据实际情况将此参数设置为 1 至 5 中的某个值。
- 如果电机在特定工况下容易过热，可以考虑设置较高的降额值（如 5），以减少电机的发热并延长使用寿命。

设定值	备注
0（默认值）	不降低电流，即最大输出电流可达电机额定电流。
1	降低 10% 的电流输出
2	降低 20% 的电流输出
3	降低 30% 的电流输出
4	降低 40% 的电流输出
5	降低 50% 的电流输出

示例配置

假设我们设置了以下参数：

- **P58 [current_derating] [电流降额]**：设置为 2，降低 20% 的电流输出。

这意味着：

- 最大输出电流 = 额定电流 \times (100% - 20%) = 额定电流 \times 80%
- 闭环控制器输出 100% 的控制量时，对应的线圈电流为 额定电流 \times 80% 。

6.8.2 MD57 系列

电流控制器用于实时跟随电流设定值，MD57 系列使用 PI 控制器实现电流控制。电流控制器参数需综合考虑系统动态需求、硬件特性及工况变化。

PI 控制器原理

PI 控制器是一种经典的线性反馈控制器，通过比例 (P) 和积分 (I) 两种控制作用，实现对电机线圈电流精确地动态调节。

数学表达式

在时域中，PI 控制器的输出 $u(t)$ 可表示为：

$$u(t) = K_p \cdot e(t) + K_i \cdot \int_0^t e(\tau) d\tau$$

其中：

- $e(t)$ ：误差值（即设定值与反馈值的差）。
- K_p ：比例增益，决定比例项的响应强度。
- K_i ：积分增益，决定积分项的修正速度。

电流控制器动态带宽与参数设计

电流控制器使用**动态带宽(BW)**来计算 PI 控制器的 K_p 和 K_i ，BW 通常以频率 (Hz) 表示。

通常情况下，动态带宽(BW)并非一个固定值，而是根据电机当前转速实时变化，以平衡高速运行时的响应需求与低速时的稳定性。

带宽(BW)的实时计算方法如下：

$$BW = \frac{\omega_{rpm} \cdot (\omega_{c1000} - \omega_c)}{1000} + \omega_c$$
$$K_p = BW \cdot 2\pi \cdot \frac{\zeta}{100}$$
$$K_i = BW^2 \cdot 2\pi \cdot \frac{1}{823548}$$

其中， ω_{rpm} 为电机当前转速 (RPM)， ω_{c1000} 为参数 P52[chopper_wc_1000rpm]， ω_c 为参数 P50[chopper_wc]， ζ 为参数 P54[chopper_zeta]。

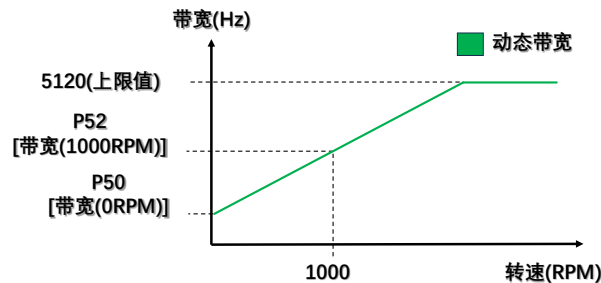

- **chopper_wc**: 零速 (0 RPM) 工况下的基础带宽，通常设置为较低值（如 1500 Hz）。
- **chopper_wc_1000rpm**: 1000 RPM 工况下的目标带宽（如 2000 Hz），用于计算动态带宽。

配置建议

- **较高的带宽**（如 1000~2000 Hz）可应对快速负载波动（如负载突变），但可能会引入高频噪声。
- **较低的带宽**（如 500~1000 Hz）转矩波动小，适用于低速，兼顾稳定性与抗干扰能力。

电流控制器阻尼比

阻尼比 (chopper_zeta, ζ) 描述系统响应的振荡程度 ($0 < \zeta < 100$):

- $\zeta = 70$: 临界阻尼, 平衡响应速度与超调量, 适用于大多数工业场景。
- $\zeta < 70$: 过阻尼, 响应慢但稳定性高。
- $\zeta > 70$: 欠阻尼, 响应快但易超调。

电流采样消隐时间

电流采样期间的消隐时间。

电流控制器需要定期采样电机绕组中的电流以调整驱动信号, 而电流采样消隐时间是指在电流采样过程中, 电机驱动器不会更新驱动信号的时间段。这段时间内, 驱动信号保持不变, 以避免在采样期间引入额外的噪声或不稳定因素。

配置建议

- 低噪声应用: 如果需要减少 EMI 噪声影响, 可以选择较长的消隐时间 (如设定值 3)。
- 快速响应应用: 如果需要提高系统的响应速度, 可以选择较短的消隐时间 (如设定值 0)。

设定值	备注
0	TBL = 1.2 us
1	TBL = 1.8 us
2 (默认值)	TBL = 2.7 us
3	TBL = 4.1 us

死区时间补偿

电流控制器根据设定的补偿值 (chopper_deadtime_comp) 修正控制量, 以补偿死区时间引起的非线性误差。

配置建议

- 该参数出厂前由厂家设定, 无需修改。

设定值	备注
0	COMP = 70 ns
1	COMP = 140 ns
2 (默认值)	COMP = 210 ns
3	COMP = 280 ns

6.9 位置速度到达检测

位置速度到达检测是驱动器的一项重要功能，用于检测电机是否已经到达预定的位置或速度。通过监测电机的实际位置和速度，并与预设的目标值进行比较，可以判断电机是否已成功到达目标位置或速度。

6.9.1 位置到达

位置到达信号是用于指示电机是否到达目标位置的重要信号。位置到达信号分为两类：斜坡位置到达 和 实际位置到达。

斜坡位置到达

斜坡位置到达信号用于指示斜坡发生器所产生的斜坡位置值等于目标位置值。

实际位置到达

实际位置到达信号用于指示实际位置到达目标位置附近，并且这个状态已经持续了一段时间（即驻留时间）。

实际位置到达信号与位置到达阈值和驻留时间相关。

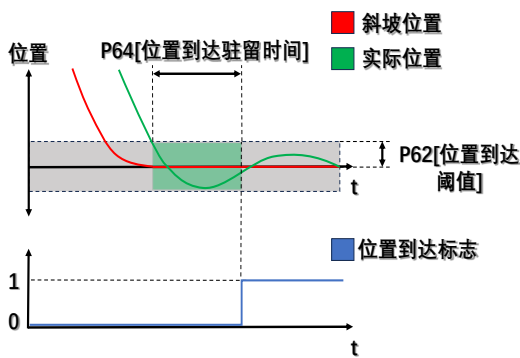

P62 [target_reached_threshold] [位置到达阈值]

设置目标位置到达的阈值。当电机的实际位置与目标位置之间的差值小于这个阈值时，认为电机已经到达目标位置。

设定值	备注	设定值	备注
6	2^6 圈 = 23040°	-2	2^{-2} 圈 = 90°
4	2^4 圈 = 5760°	-4	2^{-4} 圈 = 22.5°
2	2^2 圈 = 1440°	-6	2^{-6} 圈 = 5.625°
1	2^1 圈 = 720°	-8	2^{-8} 圈 = 1.40625°
0	2^0 圈 = 360°	-10	2^{-10} 圈 = 0.3515625°
-1	2^{-1} 圈 = 180°	-12	2^{-12} 圈 = 0.087890625°

P64 [target_reached_time] [位置到达驻留时间]

设置在位置到达阈值内需要持续的时间长度。即使电机的实际位置与目标位置之间的差值小于位置到达阈值，也需要在这个阈值内持续一段时间才能认为电机已经到达目标位置。

示例配置

假设我们设置了以下参数：

P62 [target_reached_threshold]: 设置为-10，目标位置到达的阈值为 2^{-10} 圈 (2^{-10} 圈=0.0009765625 圈=0.3515625°)。

P64 [target_reached_time]: 设置为 10，位置到达驻留时间为 10 毫秒。

这意味着：

当电机的实际位置与目标位置之间的差值小于 0.3515625°，并且这个状态持续 10 毫秒时，认为电机已经到达目标位置。

6.9.2 速度到达

速度到达信号是用于指示电机是否到达目标速度的重要信号。速度到达信号分为两类：斜坡速度到达 和 实际速度到达。

斜坡速度到达

斜坡速度到达信号用于指示斜坡发生器所产生的斜坡速度值等于目标速度值。

实际速度到达

实际速度到达信号用于指示实际速度到达目标速度附近，并且这个状态已经持续了一段时间（即驻留时间）。

实际速度到达信号与速度到达阈值和驻留时间相关。

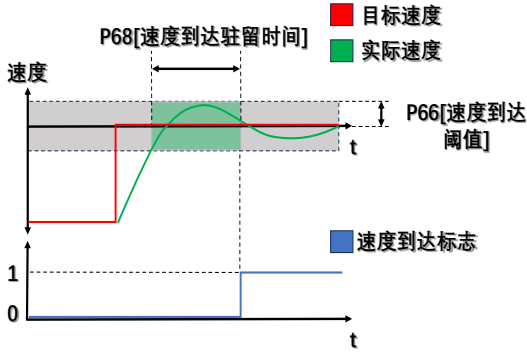

P66 [velocity_reached_threshold] [速度到达阈值]

设置目标速度到达的阈值。当电机的实际速度与目标速度之间的差值小于这个阈值时，认为电机已经到达目标速度。

P68 [velocity_reached_time] [速度到达驻留时间]

设置在速度到达阈值内需要持续的时间长度。即使电机的实际速度与目标速度之间的差值小于速度到达阈值，也需要在这个阈值内持续一段时间才能认为电机已经到达目标速度。

示例配置

假设我们设置了以下参数：

P66 [velocity_reached_threshold]: 设置为 10，目标速度到达的阈值为 10 RPM。

P68 [velocity_reached_time]: 设置为 10，速度到达驻留时间为 10 毫秒。

这意味着：

当电机的实际速度与目标速度之间的差值小于 10 RPM，并且这个状态持续 10 毫秒时，认为电机已经到达目标速度。

6.9.3 零速到达

零速到达

零速到达信号用于指示电机是否处于静止状态。

实际速度到达信号与速度到达阈值和驻留时间相关。

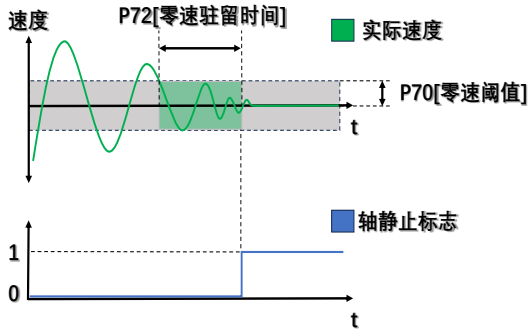

P70 [standstill_threshold] [零速阈值]

设置零速状态的速度阈值。当电机的实际速度低于这个阈值时，认为电机处于静止状态。

P72 [standstill_time] [零速驻留时间]

设置在零速阈值内需要持续的时间长度。即使电机的实际速度低于零速阈值，也需要在这个阈值内持续一段时间才能认为电机已经完全静止。

示例配置

假设我们设置了以下参数：

P70 [standstill_threshold]: 设置为 2，零速阈值为 2 RPM。

P72 [standstill_time]: 设置为 10，零速驻留时间为 10 毫秒。

这意味着：

当电机的实际速度低于 2 RPM，并且这个状态持续 10 毫秒时，认为电机已经完全静止。

6.10 保护功能

6.10.1 跟随误差监视

跟随误差监视是一项重要的保护功能，用于监控电机的实际位置与斜坡位置之间的差异。跟随误差监视确保电机的位置误差保持在安全范围内，以避免电机过载或损坏。

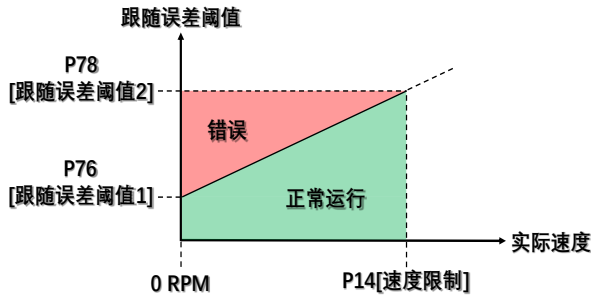

P74 [following_error_monitoring_enable] [跟随误差监视使能]

开启或关闭跟随误差监测。

设定值	备注
0	关闭跟随误差监视功能
1	开启跟随误差监视功能

P76 [following_error_threshold1] [跟随误差阈值 1]

当电机处于静止状态（0 RPM）时，允许的最大跟随误差。如果电机的实际位置与斜坡位置之间的误差超过了这个阈值，则认为电机可能存在位置控制问题。

设定值	备注	设定值	备注
6	2^6 圈 = 23040°	-2	2^{-2} 圈 = 90°
4	2^4 圈 = 5760°	-4	2^{-4} 圈 = 22.5°
2	2^2 圈 = 1440°	-6	2^{-6} 圈 = 5.625°
1	2^1 圈 = 720°	-8	2^{-8} 圈 = 1.40625°
0	2^0 圈 = 360°	-10	2^{-10} 圈 = 0.3515625°
-1	2^{-1} 圈 = 180°	-12	2^{-12} 圈 = 0.087890625°

P78 [following_error_threshold2] [跟随误差阈值 2]

当电机以 P14 最大限制速度运行时，允许的最大跟随误差。如果电机的实际位置与斜坡位置之间的误差超过了这个阈值，则认为电机可能存在位置控制问题。

设定值	备注	设定值	备注
6	2^6 圈 = 23040°	-2	2^{-2} 圈 = 90°
4	2^4 圈 = 5760°	-4	2^{-4} 圈 = 22.5°

2	2^2 圈 = 1440°	-6	2^{-6} 圈 = 5.625°
1	2^1 圈 = 720°	-8	2^{-8} 圈 = 1.40625°
0	2^0 圈 = 360°	-10	2^{-10} 圈 = 0.3515625°
-1	2^{-1} 圈 = 180°	-12	2^{-12} 圈 = 0.087890625°

P80 [following_error_time] [跟随误差过大驻留时间]

定义了检测到超出误差阈值的状态后，需要持续多久才会触发保护动作。

示例配置

假设我们设置了以下参数：

P14 [velocity_limit]: 设置为 3000，电机的最大允许速度为 3000 RPM。

P74 [following_error_monitoring_enable]: 设置为 1，开启跟随误差检测。

P76 [following_error_threshold1]: 设置为-5，跟随误差阈值 1 为 2^{-5} 圈 (2^{-5} 圈=0.03125 圈=11.25°)。

P78 [following_error_threshold2]: 设置为-2，跟随误差阈值 2 为 2^{-2} 圈 (2^{-2} 圈=0.25 圈= 90°)。

P80 [following_error_time]: 设置为 200，如果跟随误差过大状态持续 200 毫秒，则触发保护动作。

这意味着：

当电机静止时，如果实际位置与斜坡位置之间的误差超过 11.25°且持续 200ms 以上，则可能触发跟随误差监视保护。

当电机以 1500 RPM 速度运行时，如果实际位置与斜坡位置之间的误差超过 39.375°且持续 200ms 以上，则可能触发跟随误差监视保护。

当电机以 3000 RPM 速度运行时，如果实际位置与斜坡位置之间的误差超过 90°且持续 200ms 以上，则可能触发跟随误差监视保护。

6.10.2 堵转保护

堵转保护用于检测电机是否因为外部原因（如卡住或负载过大）而无法正常运转。通过监测电机的速度和转矩利用率，堵转保护可以在电机出现堵转情况时及时采取行动，避免电机过热或损坏设备。

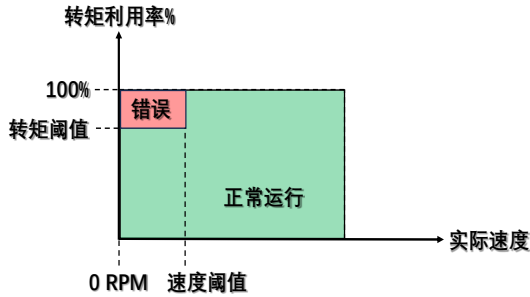

P82 [stall_protect_enable] [堵转保护使能]

开启或关闭堵转保护。

设定值	备注
0	关闭堵转保护功能
1	开启堵转保护功能

P84 [stall_protect_velocity_threshold] [堵转保护速度阈值]

设置堵转保护的速度阈值。当电机的速度低于这个阈值时，电机可能处于堵转状态。

P86 [stall_protect_torque_threshold] [堵转保护转矩阈值]

设置堵转保护的转矩阈值。当电机的转矩利用率超过这个阈值时，电机可能处于堵转状态。

P88 [stall_protect_time] [堵转保护时间]

设置在检测到堵转状态后，需要持续多长时间才会触发保护动作。

示例配置

假设我们设置了以下参数：

P82 [stall_protect_enable]: 设置为 1，开启堵转保护。

P84 [stall_protect_velocity_threshold]: 设置为 10 RPM。

P86 [stall_protect_torque_threshold]: 设置为 80 %。

P88 [stall_protect_time]: 设置为 1000 毫秒。

这意味着：

当电机速度低于 10 RPM 且转矩利用率超过 80% 时，如果这种情况持续 1000 毫秒，将会触发堵转保护。

6.10.3 硬限位保护

硬限位保护是一种用于检测电机是否接触到物理上的极限位置的保护机制，如机械限位开关。这种保护机制可以防止电机超出其物理限制，避免损坏或其他安全问题。当电机运动过程中触发硬限位，会产生一个限位到达报警，并且减速停止。

P90 [limit_protect_enable] [硬限位保护使能]

开启或关闭硬限位保护。

设定值	备注
0	关闭硬限位保护功能
1	开启硬限位保护功能

P92 [limit_switch_polarity] [硬限位信号极性]

设置硬限位信号的极性。

设定值	备注
0	常开型信号
1	常闭型信号

P94 [limit_switch_swap] [硬限位交换]

开启或关闭硬限位交换功能。

设定值	备注
0	关闭硬限位交换功能
1	开启硬限位交换功能

示例配置

假设我们设置了以下参数：

P90 [limit_protect_enable]: 设置为 1，开启硬限位保护。

P92 [limit_switch_polarity]: 设置为 1，设置硬限位信号为常闭型信号。

P94 [limit_switch_swap]: 设置为 0，不交换正负硬限位信号。

这意味着：

当电机接触到硬限位开关时，如果硬限位信号为常闭型信号，则当电机接近极限位置时，信号会断开，触发硬限位保护，电机将减速停止。

6.10.4 软限位保护

软限位保护是一种用于定义电机运动范围边界的保护机制，它通过软件设置来限制电机的运动范围，而不是依赖于物理的硬限位开关。软限位保护有助于防止电机超出其安全运行范围，避免机械碰撞或损坏。

当电机运动过程中触发软限位，会产生一个限位到达报警，并且减速停止。

注意事项

- 软限位保护功能通常在电机进行了回零操作后才会生效。这是因为回零操作确定了机械系统的零点位置后才能保证软限位的位置正确且有效。

P96 [soft_limit_protect_enable] [软限位保护使能]

开启或关闭软限位保护。

设定值	备注
0	关闭软限位保护功能
1	开启软限位保护功能

P98 [soft_positive_limit] [软正限位]

软正限位的位置，这是电机正向运动的边界。

P100 [soft_negative_limit] [软负限位]

软负限位的位置，这是电机负向运动的边界。

示例配置

假设我们设置了以下参数：

P96 [soft_limit_protect_enable]: 设置为 1，开启软限位保护。

P98 [soft_positive_limit]: 设置为 10000，表示软正限位的位置为 10000 LU。

P100 [soft_negative_limit]: 设置为 -1000，表示软负限位的位置为 -1000 LU。

这意味着：

当电机正向运动时，如果位置超过 10000 LU，则会触发软限位保护，电机将减速停止。

当电机负向运动时，如果位置低于 -1000 LU，则会触发软限位保护，电机也将减速停止。

6.10.5 急停

急停功能是一种用于在紧急情况下立即停止电机的安全机制。通过启用急停功能，可以在遇到潜在危险或异常情况时迅速停止电机的运行，以保护人员和设备的安全。

P102 [emergency_stop_enable] [急停功能使能]

开启或关闭急停功能。

设定值	备注
0	关闭急停功能
1	开启急停功能

示例配置

假设我们设置了以下参数：

P102 [emergency_stop_enable]: 设置为 1，开启急停功能。

这意味着：

一旦触发急停信号，电机将立即停止运行。

假设我们设置了以下参数：

P102 [emergency_stop_enable]: 设置为 0，关闭急停功能。

这意味着：

即使触发了急停信号，电机也不会停止。

6.11 零点搜索功能

零点搜索功能用于确定电机机械系统的绝对零点位置的过程。通过零点搜索，可以确保电机每次启动时都从同一位置开始运动，这对于许多自动化应用来说至关重要。

零点搜索分为两种方法：扭矩回零和限位回零。

扭矩回零

- 通过检测电机在移动过程中的扭矩变化来确定零点位置。
- 必须关闭硬限位功能才能进行零点搜索。

限位回零

- 通过触碰硬限位开关来确定零点位置。
- 必须开启硬限位功能才能进行零点搜索。

P106 [homing_method] [零点搜索方法]

选择使用扭矩回零还是限位回零的方法。

设定值	备注
0	扭矩回零
1	限位回零

P108 [homing_dir] [零点搜索方向]

指定零点搜索的方向。

设定值	备注
0	往负方向
1	往正方向

P110 [homing_use_z_signal] [z 信号辅助回零]

使用 Z 信号作为辅助来确定零点。

设定值	备注
0	关闭 z 信号辅助回零功能
1	开启 z 信号辅助回零功能

P112 [homing_velocity1] [零点搜索速度 1]

零点搜索的第一阶段速度。

P114 [homing_velocity2] [零点搜索速度 2]

零点搜索的第二阶段速度。

P116 [homing_torque_threshold] [扭矩回零阈值]

扭矩回零时的扭矩阈值。

P118 [homing_torque_time] [扭矩阈值到达驻留时间]

在扭矩达到阈值时需要保持的时间。

P120 [home_offset] [零点搜索完成后偏移距离]

完成零点搜索后的最终偏移量。

示例配置

假设我们选择了扭矩回零方法，并设置了以下参数：

- P106 [homing_method]: 设置为 0 (扭矩回零)。
- P108 [homing_dir]: 设置为 0, 往负方向搜索零点。
- P112 [homing_velocity1]: 设置为 100 RPM。
- P114 [homing_velocity2]: 设置为 50 RPM。
- P116 [homing_torque_threshold]: 设置为 80%。
- P118 [homing_torque_time]: 设置为 10 毫秒。
- P120 [home_offset]: 设置为 100 LU。

这意味着：

- 启动回零后电机将往负向移动，以 100 RPM 的速度进行第一阶段的零点搜索。
- 当电机检测到转矩利用率达到 80% 且保持超过 10 毫秒后，将减速至 50 RPM 反向离开。
- 在检测到转矩利用率低于 80% 后，立即将当前位置加上 100 LU 的偏移量作为最终的零点位置。
- 电机以 50 RPM 的速度移动至零点位置，回零完成。

6.12 点动功能

点动功能 (JOG) 是一种手动控制电机以低速运行的功能，通常用于对电机进行精确的手动定位。通过点动功能，操作员可以控制电机以恒定的速度移动一段特定的距离，或者通过寸动（微动）来实现更精细的定位。

P130 [jog_velocity] [JOG 点动速度]

设置点动操作的速度。当操作员按下点动按钮时，电机将以此速度运行。

P132 [jog_increase_distance] [JOG 寸动距离]

设置寸动操作时每次移动的距离。当操作员按下寸动按钮时，电机将以点动速度移动这个距离。

设定值	备注	设定值	备注
6	2^6 圈 = 23040°	-2	2^{-2} 圈 = 90°
4	2^4 圈 = 5760°	-4	2^{-4} 圈 = 22.5°
2	2^2 圈 = 1440°	-6	2^{-6} 圈 = 5.625°
1	2^1 圈 = 720°	-8	2^{-8} 圈 = 1.40625°
0	2^0 圈 = 360°	-10	2^{-10} 圈 = 0.3515625°
-1	2^{-1} 圈 = 180°	-12	2^{-12} 圈 = 0.087890625°

示例配置

假设我们设置了以下参数：

P130 [jog_velocity]: 设置为 60，点动操作的速度为 60 RPM。

P132 [jog_increase_distance]: 设置为 -2，寸动操作时每次移动的距离为 2^{-2} 圈 (2^{-2} 圈=0.25 圈= 90°)。

这意味着：

在点动模式下，当操作员按下 JOG+或 JOG-按钮时，电机将以 60 RPM 的速度运行。

在寸动模式下，当操作员按下 JOG+或 JOG-按钮时，电机将以 60RPM 的速度移动 90°。

6.13 程序块功能

程序块功能允许用户定义一系列预设的运动序列，这些序列可以被重复执行以完成复杂的运动任务。通过程序块，可以将多个运动指令组合在一起，形成一个完整的运动程序。

驱动器可保存 16 组不同的程序步，每个程序步可指定目标位置，目标速度和步的延时时间。

P134 [program_block_operation_mode] [程序块运行模式]

单次运行模式或循环运行模式的选择。

- 0: 单次运行模式。程序块将只执行一次。
- 1: 循环运行模式。程序块将无限循环执行，直到被外部命令中断。

P136 [program_block_start_step] [程序块起始步]

程序块开始执行的步骤编号。定义了程序块从哪个步骤开始执行。

P138 [program_block_end_step] [程序块结束步]

程序块结束执行的步骤编号。定义了程序块执行到哪个步骤为止。

program_block_step[n].Xtarget (程序步[n].目标位置)

第 n 个程序步骤的目标位置。

program_block_step[n].Vtarget (程序步[n].目标速度)

第 n 个程序步骤的目标速度。

program_block_step[n].delay (程序步[n].延时)

第 n 个程序步骤的延时时间。

示例配置

假设我们设置了以下参数：

P134 [program_block_operation_mode]: 设置为 1 (循环运行模式)。

P136 [program_block_start_step]: 设置为 1。

P138 [program_block_end_step]: 设置为 4。

这意味着：

程序块启动任务后将无限循环执行步骤 1 至步骤 4。

假设我们定义了以下程序步：

program_block_step[1].Xtarget: 设置为目标位置 10000 LU。

program_block_step[1].Vtarget: 设置为目标速度 6000 LU/S。

program_block_step[1].delay: 设置为 1000 毫秒。

program_block_step[2].Xtarget: 设置为目标位置 20000 LU。

program_block_step[2].Vtarget: 设置为目标速度 2000 LU/S。

program_block_step[2].delay: 设置为 500 毫秒。

program_block_step[3].Xtarget: 设置为目标位置 30000 LU。

program_block_step[3].Vtarget: 设置为目标速度 2000 LU/S。

program_block_step[3].delay: 设置为 500 毫秒。

program_block_step[4].Xtarget: 设置为目标位置 40000 LU。

program_block_step[4].Vtarget: 设置为目标速度 2000 LU/S。

program_block_step[4].delay: 设置为 500 毫秒。

这意味着：

步骤 1: 电机将以 6000 LU/S 的速度移动到 10000 单位的位置, 定位完成后等待 1000 毫秒。

步骤 2: 电机将以 2000 LU/S 的速度移动到 20000 单位的位置, 定位完成后等待 500 毫秒。

步骤 3: 电机将以 2000 LU/S 的速度移动到 30000 单位的位置, 定位完成后等待 500 毫秒。

步骤 4: 电机将以 2000 LU/S 的速度移动到 40000 单位的位置, 定位完成后等待 500 毫秒。

7 通信

7.1 控制端与被控端

在实际使用中，PLC 作为控制端设备，MDXX 系列产品作为被控端设备，它们需要周期性的进行输入输出数据(循环 I/O 数据)交换，以实现自动化控制。

如下图所示(MD42 系列)：对于控制端设备来说，它的输入对应被控端设备的输出，它的输出对应被控端设备的输入。

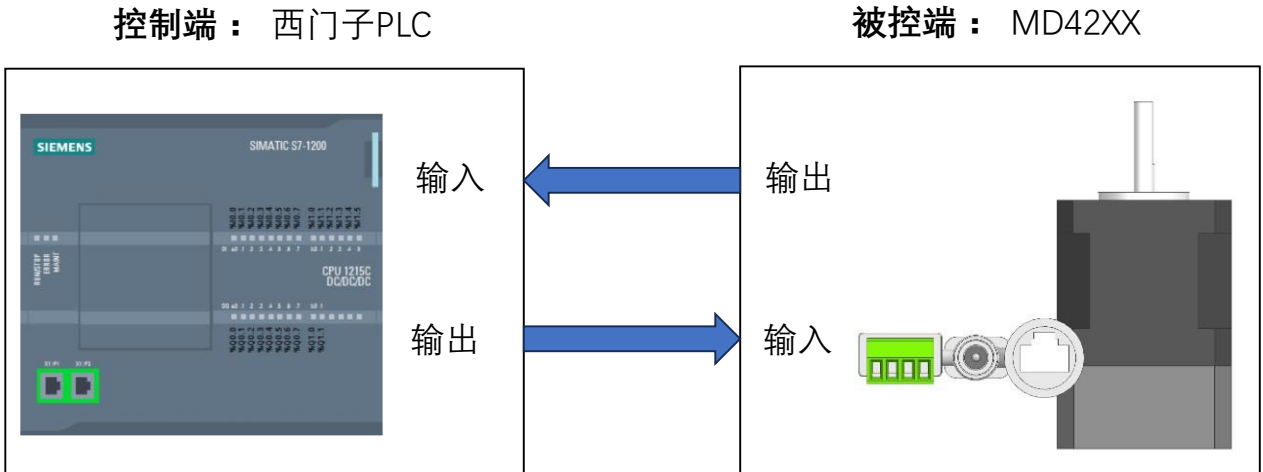

控制端与被控端示意图

后续文档将从控制端（PLC）的角度出发，详细介绍这些输入输出数据的含义。

7.2 PROFINET 通信

7.2.1 厂家报文

7.2.1.1 控制器端-循环 I/O 数据信号定义

输入(60 BYTE)	
长度(bits)	含义
32	当前位置(lu)
32	当前速度(lu/s)
32	转矩利用率
32	跟踪误差
32	状态
32	回零状态代码
32	零点位置
32	目标位置(lu)
32	目标速度(lu/s)
32	斜坡位置(lu)
32	斜坡速度(lu/s)
32	当前位置(观测值) (lu)
32	当前速度(观测值) (lu/s)
32	位置误差(lu)
32	速度误差(lu/s)
输出(20 BYTE)	
长度(bits)	含义
32	目标位置(lu)
32	目标速度(lu/s)
32	运动模式
32	控制 1
32	控制 2

注意： 样例章节中提供了外部源文件，其中定义了一个用于循环 I/O 数据信号的数据结构体，使用该数据结构体可简化使用。

7.2.1.2 控制器端-输入定义表

输入定义	类型	说明	
当前位置(lu)	Int32	当前位置(编码器值, 单位: lu)	
当前速度(lu/s)	Int32	当前速度(经滤波的编码器值, 单位: lu/s)	
转矩利用率	Int32	当前电机的转矩利用率	
跟随误差	Int32	当前位置(观测值)与斜坡位置的偏差	
状态	UInt8	BIT0	轴已使能
		BIT1	斜坡位置到达
		BIT2	斜坡速度到达
		BIT3	实际位置到达
		BIT4	实际速度到达
		BIT5	轴静止
		BIT6	轴加速中
		BIT7	轴减速中
	UInt8	BIT0	IO 信号: 正限位开关信号激活
		BIT1	IO 信号: 负限位开关信号激活
		BIT2	IO 信号: 急停开关信号激活
		BIT3	正在回零
		BIT4	回零完成(零点已设置)
		BIT5	点动/寸动运行中
		BIT6	轴正向移动中
		BIT7	轴反向移动中
	UInt8	BIT0	警告: 未回零点(零点未设置)
		BIT1	警告: 到达正限位
		BIT2	警告: 到达负限位
		BIT3	警告: 到达软正限位
		BIT4	警告: 到达软负限位
		BIT5	警告: 驱动电路高温预警(120°C)
		BIT6	警告: 电机未校准
		BIT7	报警: 到达(软/硬)限位
	UInt8	BIT0	故障: 急停已激活
		BIT1	故障: 跟随误差过大
		BIT2	故障: 电机发生堵转
		BIT3	预留
		BIT4	故障: 电机未校准
		BIT5	故障: 电机过流
		BIT6	故障: 电机开路
		BIT7	故障: 驱动电路过温(150°C)

输入定义	类型	说明	
状态 2	Uint8	回零状态代码： 0=空闲 1=搜索零点阶段 2=接近零点阶段 3=搜索编码器 Z 信号 4=移动到零点位置 5=回零完成 6=回零错误：无效的回零参数 7=回零错误：限位保护功能被使能 8=回零错误：限位保护功能未使能 9=回零错误：限位开关硬件故障（两个限位同时被触发） 10=回零错误：限位开关被触发 11=回零错误：电机堵转 12=回零错误：跟随误差过大 13=回零错误：用户停止回零	
	Uint8	BIT0	预留
		BIT1	
		BIT2	
		BIT3	
		BIT4	
		BIT5	
		BIT6	
	Uint8	BIT0	预留
BIT1			
BIT2			
BIT3			
BIT4			
BIT5			
BIT6			
Uint8	BIT0	预留	
	BIT1		
	BIT2		
	BIT3		
	BIT4		
	BIT5		
	BIT6		
零点位置	int32	当前电机的零点位置	
目标位置(lu)	int32	电机运行时的目标位置	
目标速度(lu/s)	int32	电机运行时的目标速度	
斜坡位置(lu)	int32	斜坡发生器输出的位置	
斜坡速度(lu/s)	int32	斜坡发生器输出的速度	
当前位置(观测值) (lu)	int32	LESO 观测器输出的当前位置	

输入定义	类型	说明
当前速度(观测值) (lu/s)	int32	LESO 观测器输出的当前速度
位置误差(lu)	int32	当前位置(观测值)与斜坡位置的偏差
速度误差(lu/s)	int32	当前速度(观测值)与斜坡速度的偏差

注：类型 int32 为 32 位有符号整数、uint32 为 32 位无符号整数。

7.2.1.3 控制器端-输出定义表

输出定义	类型	说明	
目标位置(lu)	int32	设定位置(lu)	
目标速度(lu/s)	int32	设定速度(lu/s)	
运动模式	int32	运动模式:	
		0=电机失能	
		1=相对位置模式	
		2=绝对位置模式	
		3=速度模式	
		4=主动回零模式	
		5=零点设置模式	
		6=程序步模式	
		7=点动模式	
8=寸动模式			
控制 1	Uint8	BIT0	预留
		BIT1	取消任务 0 = 取消当前的运行任务 1 = 不取消当前的运行任务
		BIT2	暂停任务 0 = 暂停当前运行任务 1 = 不暂停当前运行任务
		BIT3	预留
		BIT4	预留
		BIT5	JOG+(正方向)
		BIT6	JOG-(负方向)
		BIT7	预留
	Uint8	BIT0	确认错误
		BIT1	启动任务
		BIT2	预留
		BIT3	
		BIT4	
		BIT5	
		BIT6	
	BIT7		
	Uint8	BIT0	预留
		BIT1	
		BIT2	
		BIT3	
		BIT4	
		BIT5	
		BIT6	
	Uint8	BIT0	预留
BIT1		被动回零功能 0=关闭 1=开启	

输出定义	类型	说明
	BIT2	激活软限位功能(零点设置后生效)
	BIT3	激活硬限位功能(与调试软件中启用硬限位功能互为“或”逻辑, 两者满足其一即生效)
	BIT4	被动回零模式 - 零点信号
	BIT5	预留
	BIT6	预留
	BIT7	传输方式 0=单步传输 (通过<启动任务>上升沿接收新的设定值) 1=连续传输 (立即接收新的设定值)
控制 2	int8	速度倍率 (输入范围: -100% 到 100%) (速度倍率作用于所有运动模式)
	int8	加速度倍率 (输入范围: -100% 到 0%) (加速度倍率不适用于主动回零、点动及寸动模式)
	Uint8	预留
	Uint8	预留

注: 类型 int32 为 32 位有符号整数、uint32 为 32 位无符号整数。

7.2.2 报文 111

7.2.2.1 控制器端-循环 I/O 数据信号定义

报文 111		
过程数据	输入 (驱动器->PLC)	输出 (PLC->驱动器)
PZD1	ZSW1	STW1
PZD2	POS_ZSW1	POS_STW1
PZD3	POS_ZSW2	POS_STW2
PZD4	ZSW2	STW2
PZD5	MELDW	OVERRIDE
PZD6	XIST_A	MDI_TARPOS
PZD7		
PZD8	NIST_B	MDI_VELOCITY
PZD9		
PZD10	FAULT_CODE	MDI_ACC
PZD11	WARN_CODE	MDI_DEC
PZD12	USER	USER

7.2.2.2 控制器端-输入定义表

输入定义	报文结构		说明
PZD1	ZSW1(uint16)	BIT0	接通就绪
		BIT1	运行准备就绪
		BIT2	运行使能
		BIT3	故障存在
		BIT4	"滑行下降"未激活
		BIT5	"快速停止"未激活
		BIT6	"禁止开关接通"激活
		BIT7	报警存在
		BIT8	预留
		BIT9	控制请求 驱动器已准备好接受数据
		BIT10	到达目标位置
		BIT11	参考点设置
		BIT12	预留
		BIT13	轴已静止
		BIT14	轴正在加速度
BIT15	轴正在减速度		
PZD2	POS_ZSW1(uint16)	BIT0	预留
		BIT1	
		BIT2	
		BIT3	
		BIT4	
		BIT5	
		BIT6	
		BIT7	
		BIT8	反向接近开关激活
		BIT9	正向接近开关激活
		BIT10	点动激活
		BIT11	回零程序激活
		BIT12	预留
		BIT13	
		BIT14	设置激活
BIT15	MDI 激活		
PZD3	POS_ZSW2(uint16)	BIT0	预留
		BIT1	
		BIT2	
		BIT3	
		BIT4	轴正向移动
		BIT5	轴反向移动

		BIT6	反向软限位开关到达
		BIT7	正向软限位开关到达
		BIT8	预留
		BIT9	
		BIT10	
		BIT11	
		BIT12	
		BIT13	
		BIT14	
		BIT15	
PZD4	ZSW2(uint16)	BIT0	预留
		BIT1	
		BIT2	
		BIT3	
		BIT4	
		BIT5	
		BIT6	
		BIT7	
		BIT8	
		BIT9	
		BIT10	脉冲使能
		BIT11	预留
		BIT12	
		BIT13	
BIT14			
BIT15			
PZD5	MELDW(uint16)	BIT0	预留
		BIT1	
		BIT2	
		BIT3	
		BIT4	
		BIT5	
		BIT6	
		BIT7	
		BIT8	
		BIT9	
		BIT10	
		BIT11	
		BIT12	
		BIT13	
BIT14			

		BIT15	
PZD6	XIST_A(int32)		位置实际值
PZD7			
PZD8	NIST_B(int32)		速度实际值
PZD9			
PZD10	FAULT_CODE(uint16)		故障代码
PZD11	WARN_CODE(uint16)		警告代码
PZD12	USER (uint16)	BIT0	急停信号
		BIT1	负限位信号
		BIT2	正限位信号
		BIT3	预留
		BIT4	DI1 端口状态
		BIT5	预留
		BIT6	DO1 端口状态
		BIT7	预留
		BIT8	探针 1 状态
		BIT9	预留
		BIT10	抱闸 1 状态
		BIT11	预留
		BIT12	预留
		BIT13	预留
		BIT14	预留
BIT15	预留		

7.2.2.3 控制器端-输出定义表

输出定义	报文结构	说明	
PZD1	STW1(uint16)	BIT0	轴的运行命令/变频器启动
		BIT1	"无滑行下降"命令
		BIT2	"无快速停止"命令
		BIT3	运行使能（脉冲使能与封锁）
		BIT4	停止任务 1: 不激活 0: 激活
		BIT5	停止命令 1: 不激活 0: 激活
		BIT6	激活程序步任务\启动 MDI
		BIT7	故障确认
		BIT8	点动 1 命令
		BIT9	点动 2 命令
		BIT10	预留
		BIT11	启动回参考点命令
		BIT12	预留
		BIT13	
		BIT14	
BIT15			
PZD2	POS_STW1(uint16)	BIT0	预留
		BIT1	
		BIT2	
		BIT3	
		BIT4	
		BIT5	
		BIT6	
		BIT7	
		BIT8	直接数据输入/MDI_定位模式 1: 绝对位置 0: 相对位置
		BIT9	直接数据输入/MDI_方向选择 正向
		BIT10	直接数据输入/MDI_方向选择 反向
		BIT11	预留
		BIT12	直接数据输入/MDI_数据传输方式 1: 连续 0: 单步
		BIT13	预留
		BIT14	直接数据输入/MDI_设置选择 1: 速度模式 0:位置模式
BIT15	直接数据输入/MDI_选择（激活 MDI 功能）		
PZD3	POS_STW2(uint16)	BIT0	预留
		BIT1	激活轴的“设置参考点”命令，将当前位置设置成零位。
		BIT2	预留
		BIT3	
		BIT4	
		BIT5	设置点动模式 0: 速度模式 1: 位置模式

		BIT6	预留
		BIT7	
		BIT8	选择回参考点方式 0: 主动回零 1: 被动回零
		BIT9	设置寻参考点方向 0: 正向回零 1: 反向回零
		BIT10	预留
		BIT11	
		BIT12	
		BIT13	
		BIT14	激活软限位功能(零点设置后生效)
		BIT15	激活硬限位功能(与调试软件中启用硬限位功能互为“或”逻辑, 两者满足其一即生效)
PZD4	STW2(uint16)		预留
PZD5	Override(uint16)		速率极限值 (4000H 对应 100%)
PZD6	MDI_TARPOS(int32)		双字: MDI 位置值 (单位: LU)
PZD7			
PZD8	MDI_VELOCITY(int32)		双字: MDI 速度给定 (单位: 1000LU/min)
PZD9			
PZD10	MDI_ACC_DEC(uint16)		MDI 加减速度(4000H 对应 100%)
PZD11	RESERVED(uint16)		预留
PZD12	USER (uint16)	BIT0	DO1 控制位
		BIT1	
		BIT2	
		BIT3	
		BIT4	
		BIT5	
		BIT6	
		BIT7	
		BIT8	
		BIT9	
		BIT10	
		BIT11	
		BIT12	
		BIT13	
BIT14			
BIT15			

7.2.2.4 警告代码 & 错误代码

字	结构体	说明	
WARN_CODE	Uint16	BIT0	未回零点 (零点未设置)
		BIT1	到达正限位
		BIT2	到达负限位
		BIT3	到达软正限位
		BIT4	到达软负限位
		BIT5	驱动电路高温预警 (120°C)
		BIT6	电机未校准
		BIT7	预留
		BIT8	
		BIT9	
		BIT10	
		BIT11	
		BIT12	
		BIT13	
		BIT14	
BIT15			
FAULT_CODE	Uint16	BIT0	急停已激活
		BIT1	跟随误差过大
		BIT2	电机堵转
		BIT3	电机未校准
		BIT4	电机 A 相对地短路
		BIT5	电机 B 相对地短路
		BIT6	驱动电路过温保护
		BIT7	预留
		BIT8	
		BIT9	
		BIT10	
		BIT11	
		BIT12	
		BIT13	
		BIT14	
BIT15			

7.3 MODBUS TCP 通信

7.3.1 设备连接参数

参数名称	值	描述
IP 地址	设备 IP	出厂默认 192.168.200.244, 可用配置软件修改
端口号	502	
从站 ID(单元标识符)	1	

7.3.2 功能码

功能码	功能	操作数量
03H	读保持寄存器	单个/多个
04H	读输入寄存器	单个/多个
06H	写单个保持寄存器	单个
10H	写多个保持寄存器	多个

7.3.3 寄存器地址范围

寄存器	PLC 地址	协议地址	数量
输入寄存器	30001 - 30030	0 - 31	32
保持寄存器	40001 - 40010	0 - 15	16

7.3.4 输入寄存器定义

协议地址	字序	名称	类型	说明		
[0]	高	当前位置(lu)	int32	当前位置(编码器值, 单位: lu)		
[1]	低					
[2]	高	当前速度(lu/s)	int32	当前速度(经滤波的编码器值, 单位: lu/s)		
[3]	低					
[4]	高	转矩利用率	int32	当前电机的转矩利用率		
[5]	低					
[6]	高	跟踪误差	int32	当前位置(观测值)与斜坡位置的偏差		
[7]	低					
[8]	高	状态	Uint16	BIT0	警告: 未回零点 (原点未设置)	
				BIT1	警告: 到达正限位	
				BIT2	警告: 到达负限位	
				BIT3	警告: 到达软正限位	
				BIT4	警告: 到达软负限位	
				BIT5	警告: 驱动电路高温预警	
				BIT6	警告: 电机未校准	
				BIT7	报警: 到达 (软/硬) 限位	
				BIT8	故障: 急停已激活	
				BIT9	故障: 跟随误差过大	
				BIT10	故障: 电机发生堵转	
				BIT11	预留	
				BIT12	故障: 电机未校准	
				BIT13	故障: 电机过流	
				BIT14	故障: 电机开路	
BIT15	故障: 驱动电路过温 (150°C)					
[9]	低		状态	Uint16	BIT0	轴已使能
					BIT1	斜坡位置到达
					BIT2	斜坡速度到达
					BIT3	实际位置到达
					BIT4	实际速度到达
					BIT5	轴静止
					BIT6	轴加速中
					BIT7	轴减速中
					BIT8	IO 信号: 正限位开关信号激活
					BIT9	IO 信号: 负限位开关信号激活
					BIT10	IO 信号: 急停开关信号激活
					BIT11	正在回零
					BIT12	回零完成 (原点已设置)
					BIT13	点动/寸动运行中
		BIT14			轴正向移动中	
BIT15	轴反向移动中					
[10]	高	回零状态代码		int32	回零状态代码:	
					0=空闲	
					1=搜索零点阶段	

协议地址	字序	名称	类型	说明																																																					
[11]	低			2=接近零点阶段																																																					
				3=搜索编码器 Z 信号																																																					
				4=移动到零点位置																																																					
				5=回零完成																																																					
				6=回零错误: 无效的回零参数																																																					
				7=回零错误: 限位保护功能被使能																																																					
				8=回零错误: 限位保护功能未使能																																																					
				9=回零错误: 限位开关硬件故障 (两个限位同时被触发)																																																					
				10=回零错误: 限位开关被触发																																																					
				11=回零错误: 电机堵转																																																					
				12=回零错误: 跟随误差过大																																																					
				13=回零错误: 用户停止回零																																																					
				[12]	高	零点位置	int32	当前电机的零点位置																																																	
[13]	低	[14]	高	目标位置(lu)	int32				电机运行时的目标位置	[15]	低	[16]	高	目标速度(lu/s)	int32	电机运行时的目标速度	[17]	低	[18]	高	斜坡位置(lu)	int32	斜坡发生器输出的位置	[19]	低	[20]	高	斜坡速度(lu/s)	int32	斜坡发生器输出的速度	[21]	低	[22]	高	当前位置(观测值) (lu)	int32	LESO 观测器输出的当前位置	[23]	低	[24]	高	当前速度(观测值) (lu/s)	int32	LESO 观测器输出的当前速度	[25]	低	[26]	高	位置误差(lu)	int32	当前位置(观测值)与斜坡位置的偏差	[27]	低	[28]	高	速度误差(lu/s)	int32
[14]	高	目标位置(lu)	int32			电机运行时的目标位置																																																			
[15]	低			[16]	高		目标速度(lu/s)	int32	电机运行时的目标速度	[17]	低	[18]	高	斜坡位置(lu)	int32	斜坡发生器输出的位置	[19]	低	[20]	高	斜坡速度(lu/s)	int32	斜坡发生器输出的速度	[21]	低	[22]	高	当前位置(观测值) (lu)	int32	LESO 观测器输出的当前位置	[23]	低	[24]	高	当前速度(观测值) (lu/s)	int32	LESO 观测器输出的当前速度	[25]	低	[26]	高	位置误差(lu)	int32	当前位置(观测值)与斜坡位置的偏差	[27]	低	[28]	高	速度误差(lu/s)	int32	当前速度(观测值)与斜坡速度的偏差	[29]	低				
[16]	高	目标速度(lu/s)	int32	电机运行时的目标速度																																																					
[17]	低				[18]	高	斜坡位置(lu)	int32	斜坡发生器输出的位置	[19]	低	[20]	高	斜坡速度(lu/s)	int32	斜坡发生器输出的速度	[21]	低	[22]	高	当前位置(观测值) (lu)	int32	LESO 观测器输出的当前位置	[23]	低	[24]	高	当前速度(观测值) (lu/s)	int32	LESO 观测器输出的当前速度	[25]	低	[26]	高	位置误差(lu)	int32	当前位置(观测值)与斜坡位置的偏差	[27]	低	[28]	高	速度误差(lu/s)	int32	当前速度(观测值)与斜坡速度的偏差	[29]	低											
[18]	高	斜坡位置(lu)	int32	斜坡发生器输出的位置																																																					
[19]	低				[20]	高	斜坡速度(lu/s)	int32	斜坡发生器输出的速度	[21]	低	[22]	高	当前位置(观测值) (lu)	int32	LESO 观测器输出的当前位置	[23]	低	[24]	高	当前速度(观测值) (lu/s)	int32	LESO 观测器输出的当前速度	[25]	低	[26]	高	位置误差(lu)	int32	当前位置(观测值)与斜坡位置的偏差	[27]	低	[28]	高	速度误差(lu/s)	int32	当前速度(观测值)与斜坡速度的偏差	[29]	低																		
[20]	高	斜坡速度(lu/s)	int32	斜坡发生器输出的速度																																																					
[21]	低				[22]	高	当前位置(观测值) (lu)	int32	LESO 观测器输出的当前位置	[23]	低	[24]	高	当前速度(观测值) (lu/s)	int32	LESO 观测器输出的当前速度	[25]	低	[26]	高	位置误差(lu)	int32	当前位置(观测值)与斜坡位置的偏差	[27]	低	[28]	高	速度误差(lu/s)	int32	当前速度(观测值)与斜坡速度的偏差	[29]	低																									
[22]	高	当前位置(观测值) (lu)	int32	LESO 观测器输出的当前位置																																																					
[23]	低				[24]	高	当前速度(观测值) (lu/s)	int32	LESO 观测器输出的当前速度	[25]	低	[26]	高	位置误差(lu)	int32	当前位置(观测值)与斜坡位置的偏差	[27]	低	[28]	高	速度误差(lu/s)	int32	当前速度(观测值)与斜坡速度的偏差	[29]	低																																
[24]	高	当前速度(观测值) (lu/s)	int32	LESO 观测器输出的当前速度																																																					
[25]	低				[26]	高	位置误差(lu)	int32	当前位置(观测值)与斜坡位置的偏差	[27]	低	[28]	高	速度误差(lu/s)	int32	当前速度(观测值)与斜坡速度的偏差	[29]	低																																							
[26]	高	位置误差(lu)	int32	当前位置(观测值)与斜坡位置的偏差																																																					
[27]	低				[28]	高	速度误差(lu/s)	int32	当前速度(观测值)与斜坡速度的偏差	[29]	低																																														
[28]	高	速度误差(lu/s)	int32	当前速度(观测值)与斜坡速度的偏差																																																					
[29]	低																																																								

注: 类型 int32 为 32 位有符号整数、uint32 为 32 位无符号整数。

7.3.5 保持寄存器定义

协议地址	字序	名称	类型	说明
[0]	高	目标位置(lu)	int32	设定位置(lu)
[1]	低			
[2]	高	目标速度 (lu/s)	int32	设定速度(lu/s)
[3]	低			
[4]	高	运动模式	int32	运动模式:
				0=电机失能
				1=相对位置模式
				2=绝对位置模式
				3=速度模式
				4=主动回零模式
[5]	低			5=零点设置模式
				6=程序步模式
		7=点动模式		
		8=寸动模式		
[6]	高	控制 1	Uint16	BIT0
				BIT1
				BIT2
				BIT3
				BIT4
				BIT5
				BIT6
				BIT7
				BIT8
				BIT9
				BIT10
				BIT11
				BIT12
				BIT13
		BIT14		
		BIT15		
		BIT0		
		BIT1		
		BIT2		
		BIT3		
		BIT4		

协议地址	字序	名称	类型	说明
			BIT5	JOG+(正方向)
			BIT6	JOG-(负方向)
			BIT7	预留
			BIT8	确认错误
			BIT9	启动任务
			BIT10	预留
			BIT11	
			BIT12	
			BIT13	
			BIT14	
			BIT15	
[8]	低	控制 2	Uint8	预留
	高		Uint8	预留
[9]	低		int8	速度倍率 (输入范围: -100% 到 100%) (速度倍率作用于所有运动模式)
	高		int8	加速度倍率 (输入范围: -100% 到 0%), 不适用于主动回零、 点动及寸动模式

注: 类型 int32 为 32 位有符号整数、uint32 为 32 位无符号整数。

8 样例

8.1 西门子 S7-1200 样例(PROFINET)

8.1.1 涉及软硬件

- 硬件：
- 1、S7-1200 CPU1212C AC/DC/RLY
 - 2、百川 MD 系列 PROFINET 一体式步进伺服
 - 3、计算机
 - 4、网线
 - 5、交换机

软件： 1、TIA Portal V18 2、BCZY DTools

配置文件： GSDML-V2.32-BCZY-MDSERIES-MODULE-20251110.xml

外部源文件： MD_PN.scl 、 MD_PN_CTRL.scl

8.1.2 硬件连接

8.1.2.1 建立连接

本一体式步进伺服采用 DC 24V ($\pm 15\%$) 输入，本样例将使用 AC100-240V 转 DC24V 作为输入电源。

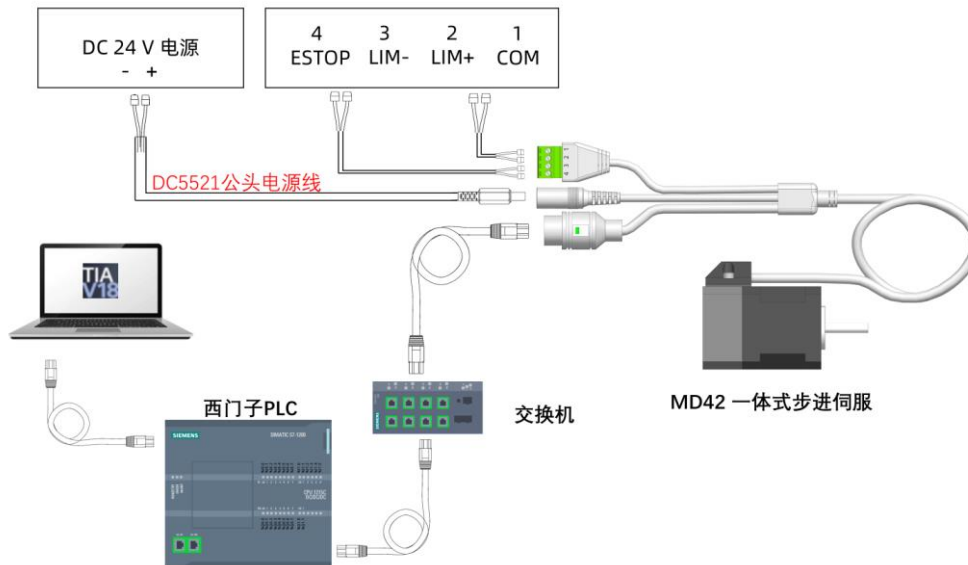

使用 DC5521 公头电源线将 DC24V 接入一体式步进伺服 DC5521 母头。

通过标准 RJ45 网线将调试计算机、PLC、一体式步进伺服连接到交换机组网。

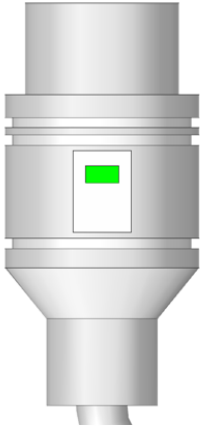

8.1.2.2 检查系统指示灯

电源通电后，未完成组态时，状态如下表 状态 2 间隔短闪。

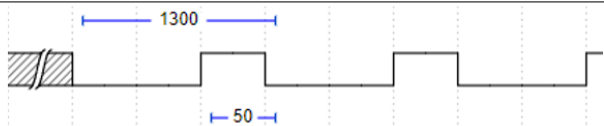
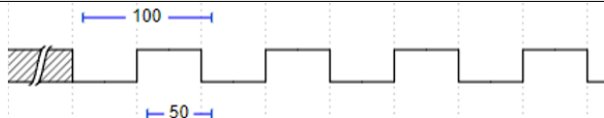
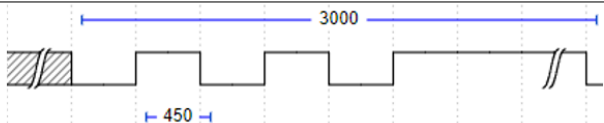
LED灯	状态	LED闪烁波形(单位:ms)
	1、常亮。控制器已连接通信正常	
	2、间隔短闪。无控制器连接	
	3、快闪。设备初始化	
	4、周期闪烁三次后恢复1/2/3状态。查找设备功能	

8.1.3 添加配置文件

8.1.3.1 添加 GSD 文件

选项 -> 管理通用站描述文件(GSD)

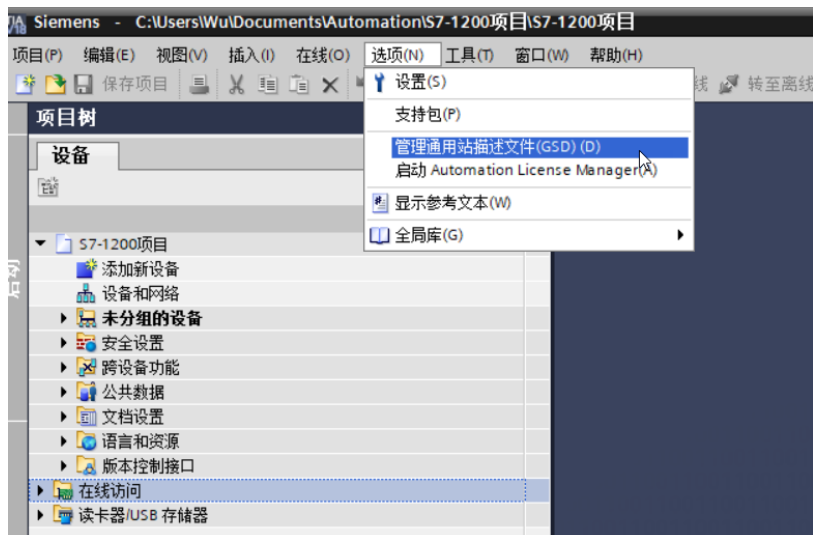

根据 GSD 文件所在目录切换路径，勾选并安装。

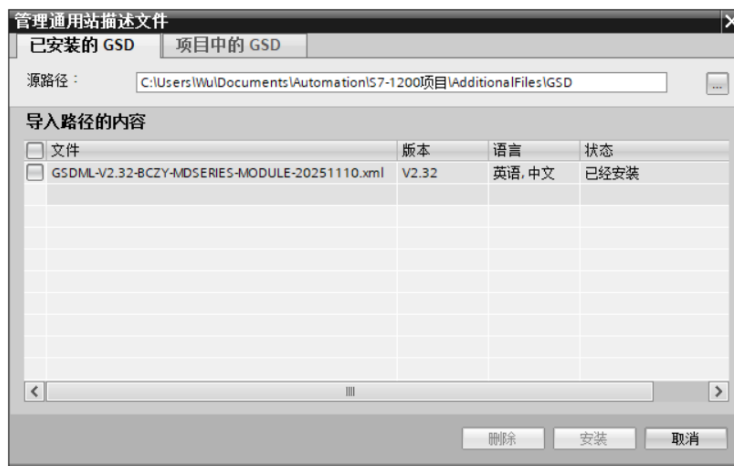

等待安装完成。



8.1.4 组态

8.1.4.1 添加控制器并设置 IP 地址

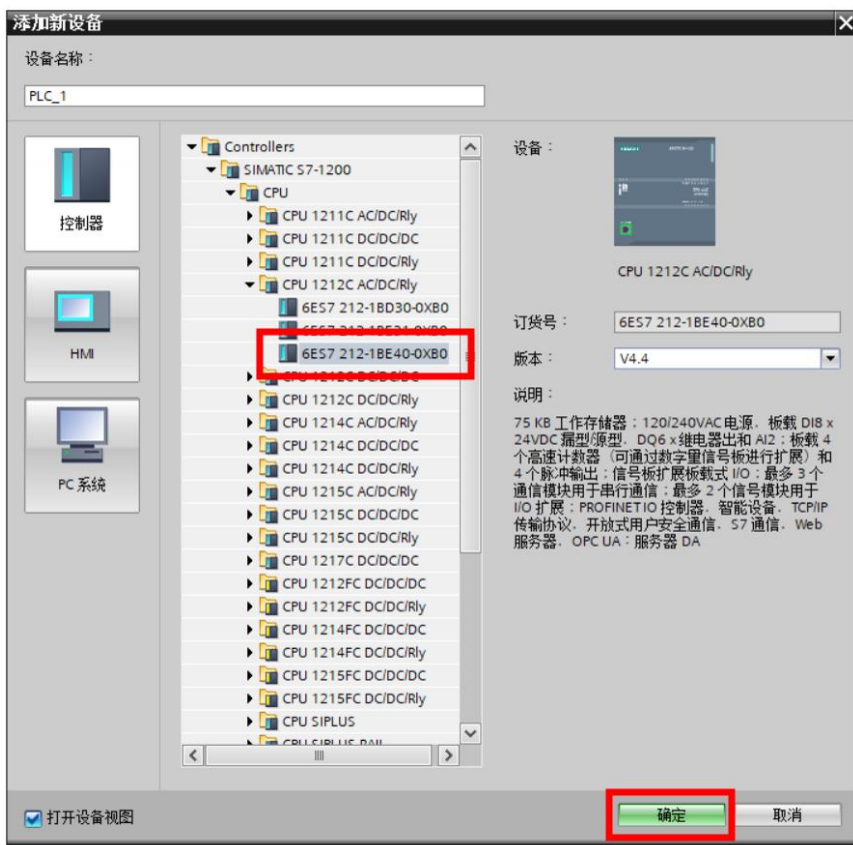
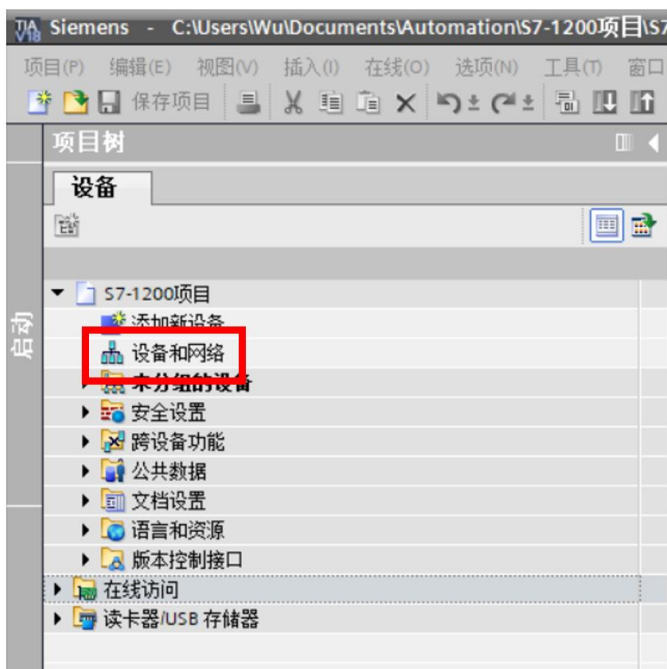

点击: PROFINET 接口[X1] -> 以太网地址 -> 添加新子网 -> 设置控制器 PLC 地址。

此样例 PLC 控制器 IP 地址设置为 192.168.0.16

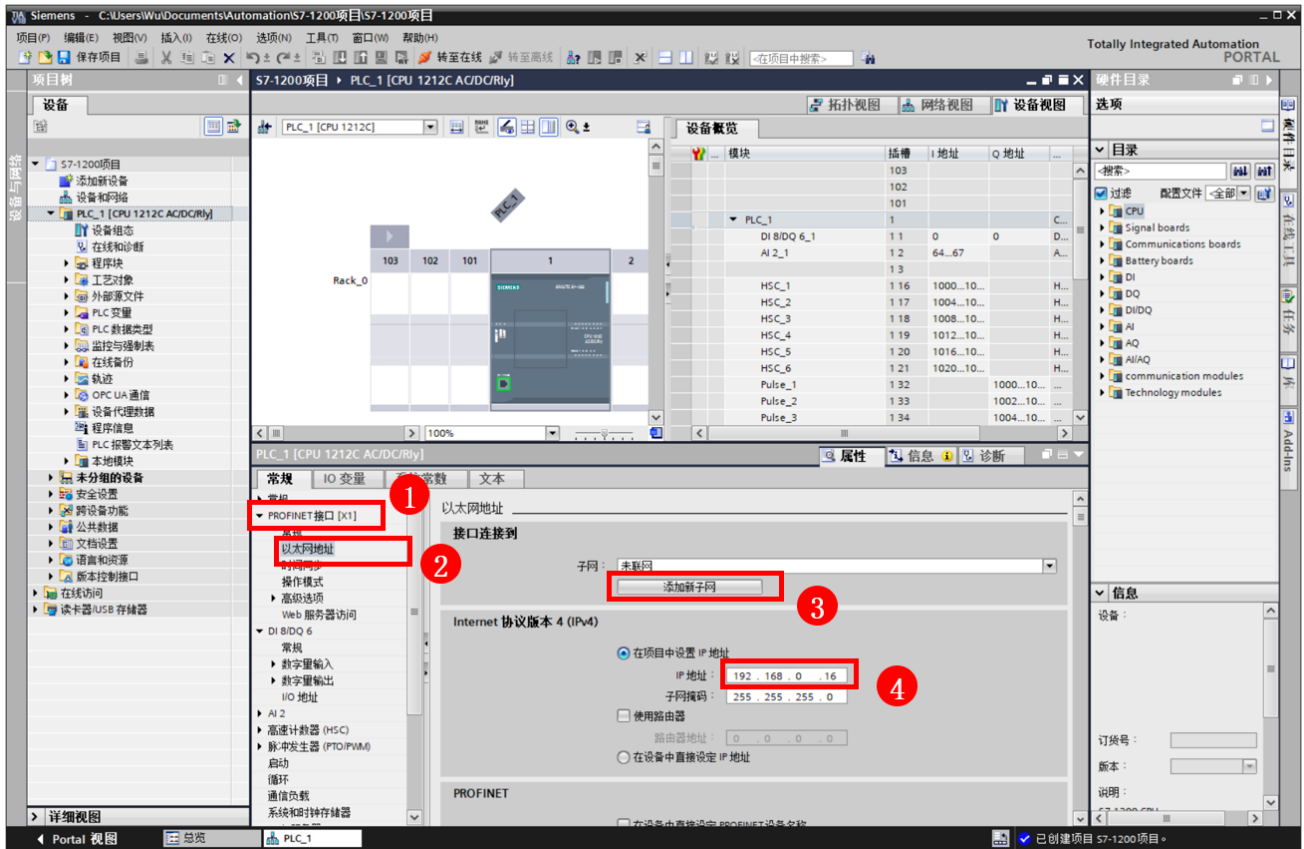

8.1.4.2 添加设备

点击：网络视图 -> 硬件目录 -> 其他现场设备 -> PROFINET IO -> Drives -> BCZY -> BCZY_Drives -> MD_Series

请确认 GSD 版本与先前添加的文件为同一版本

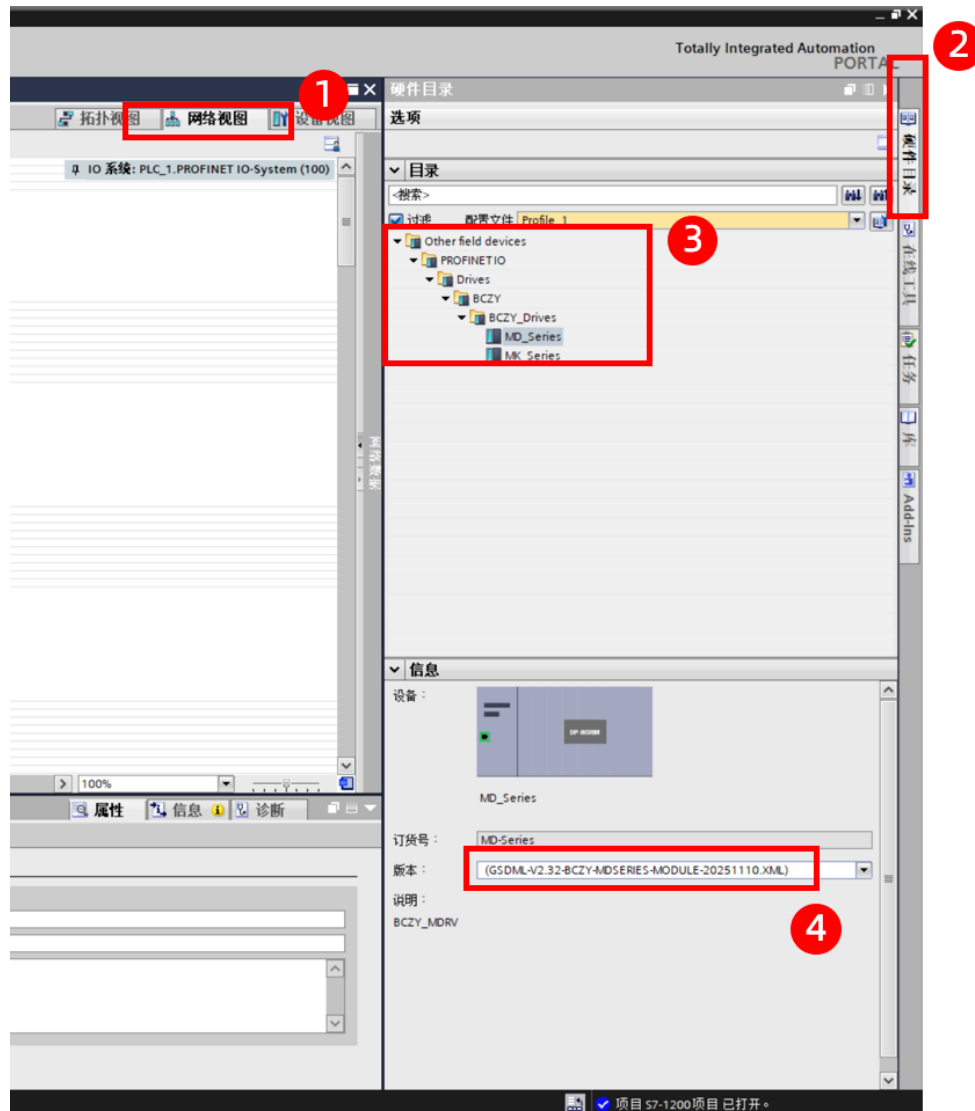

将 MD_Series 拖入网络视图

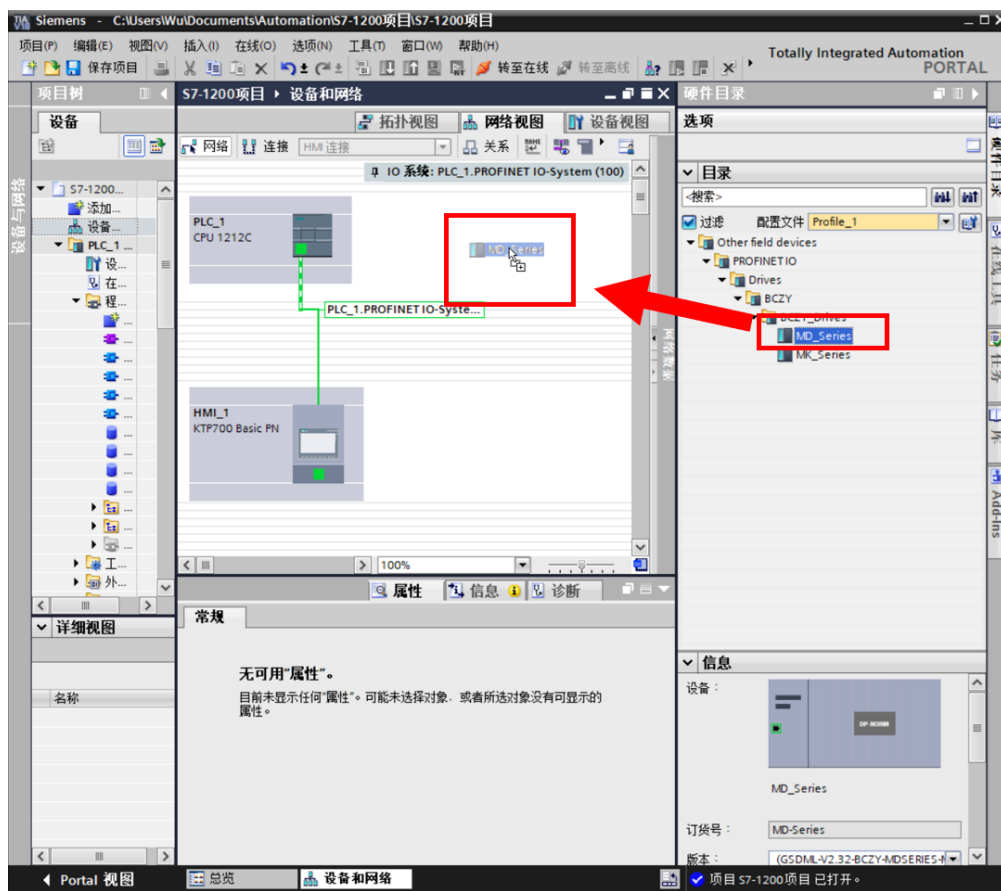

选择设备，切换设备视图



添加要使用的控制报文， 可选择 厂家报文 / 西门子报文 111

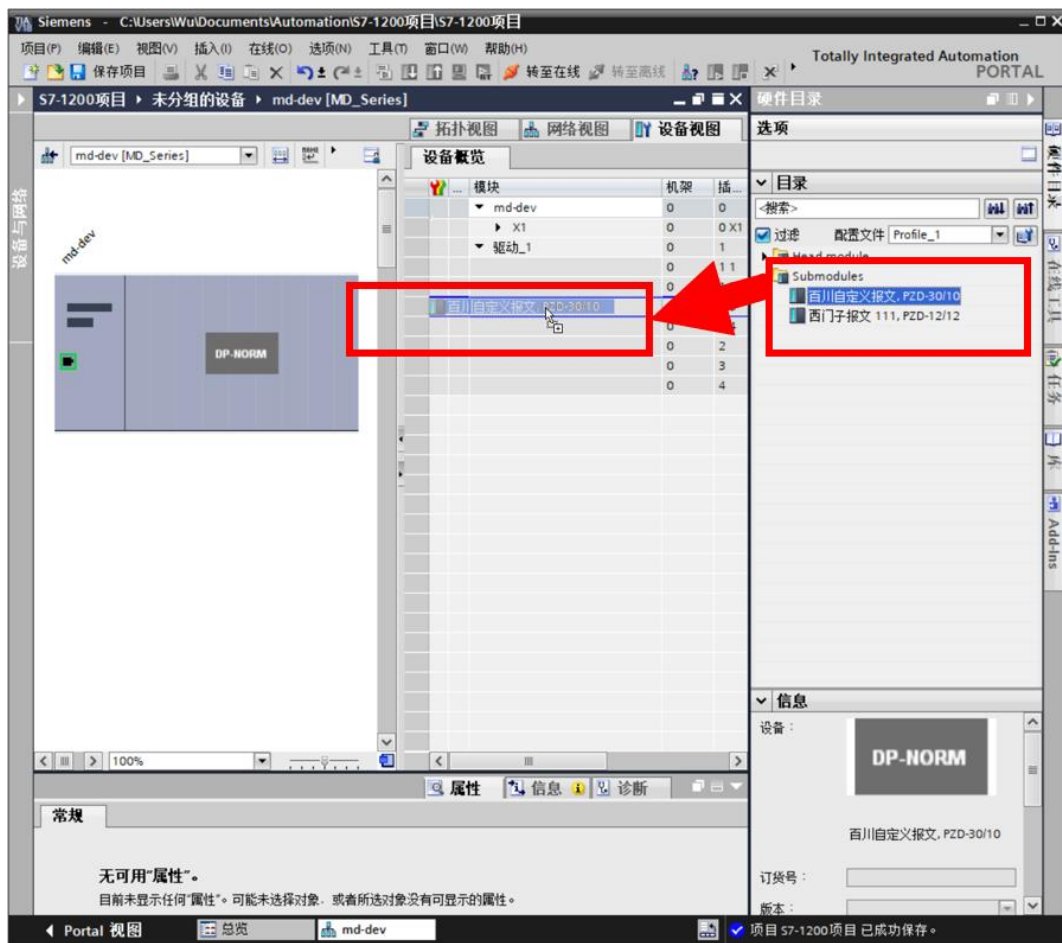

点击：未分配 -> PLC_1.PROFINET 接口_1

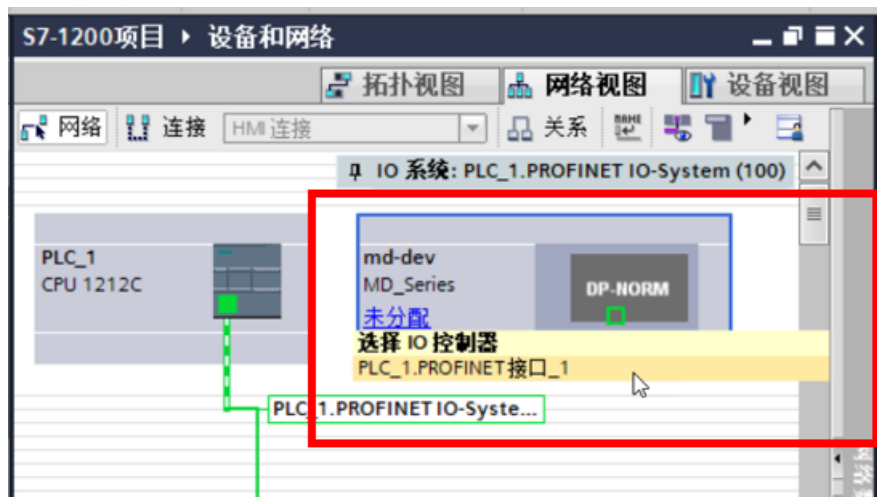

设定设备的 IP 地址为 192.168.0.17

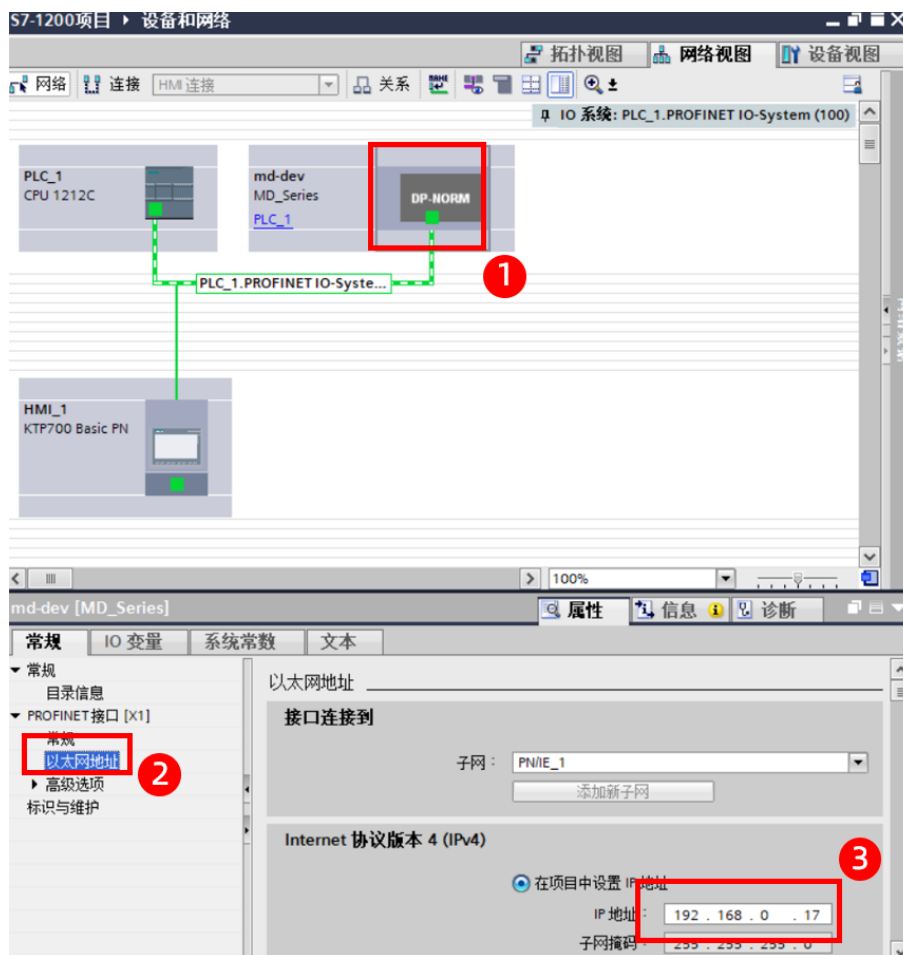

8.1.4.3修改设备名称

点击： PLC -> 下载 -> 选择对应网卡 -> 插槽“1 X1”处的方向 -> 开始搜索

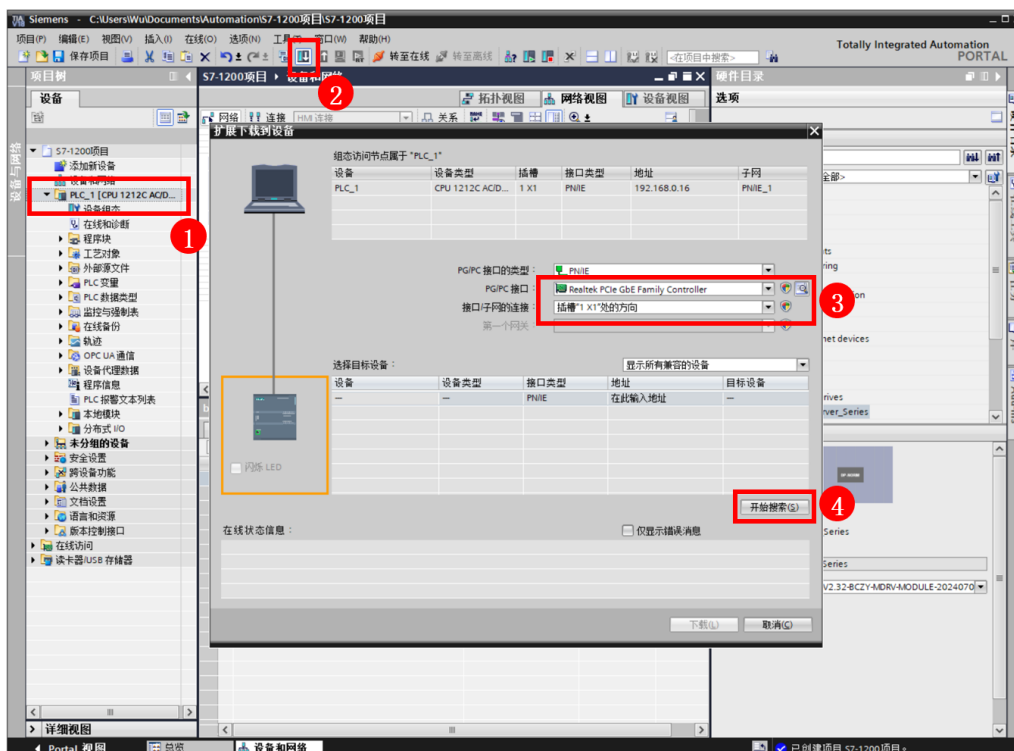

选择对应的 PLC -> 下载



装载 -> 完成 -> 转至在线

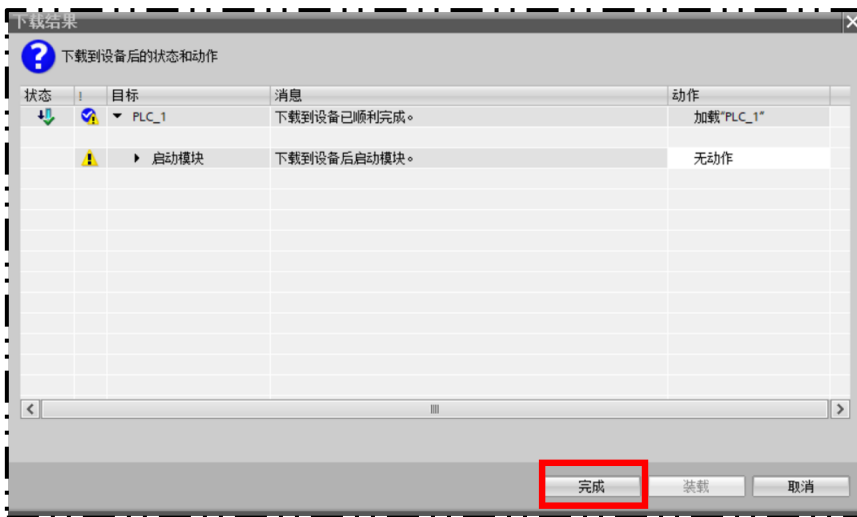
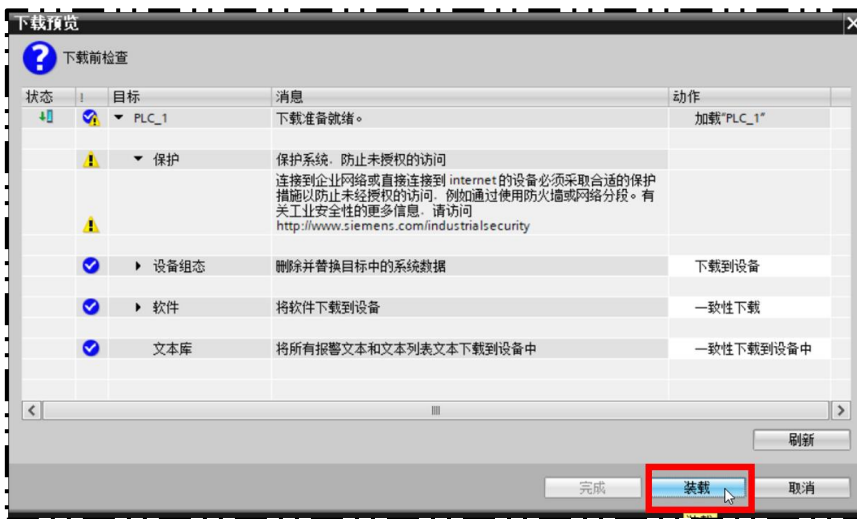

初次连接的设备需要分配设备名称以对应组态。

以下是将组态设备名称“转盘供料电机”分配给实际设备的样例：

双击：未分组的设备 -> **右键**：转盘供料电机 -> 分配设备名称

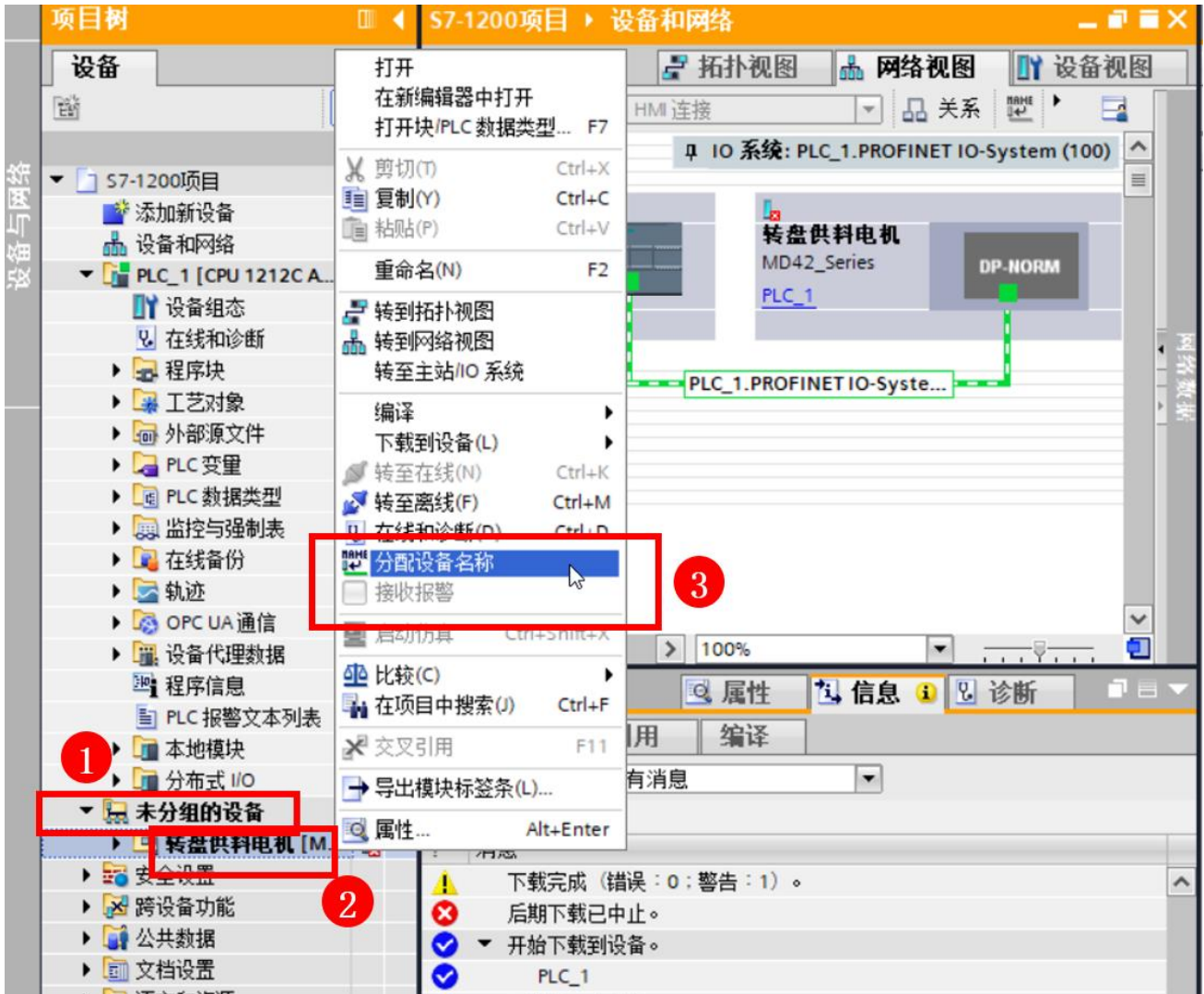

更新列表 -> 点击搜索出的设备 -> 分配名称 -> 关闭



正常连接如下图

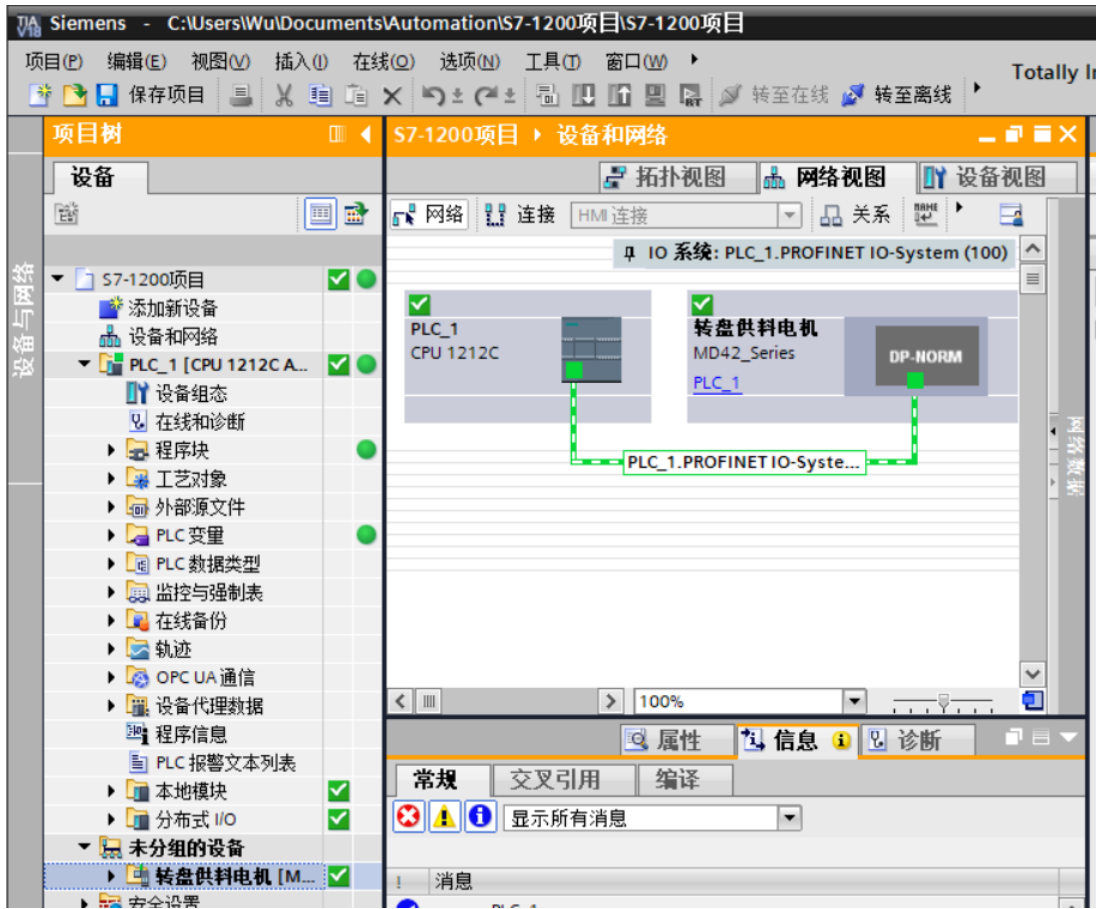

建立通信成功后连接状态 LED 灯常亮

LED灯	状态	LED闪烁波形(单位:ms)
	1、常亮。控制器已连接通信正常	
	2、间隔短闪。无控制器连接	
	3、快闪。设备初始化	
	4、周期闪烁三次后恢复1/2/3状态。查找设备功能	

8.1.5 控制电机

8.1.5.1 控制方法

用户可根据实际需求，选择使用“厂家报文”或“报文 111”进行控制。以下分别介绍这两种报文的控制方法。

一、使用“厂家报文”控制时，可选用样例中提供的 SCL 文件。

1、MD_PN_CTRL.scl: 可通过引脚直接控制电机运行。

外部源文件名称	引脚
MD_PN_CTRL.scl	<pre> %DB2 "MD_PN_CTRL_DB" %F85 "MD_PN_CTRL" EN 0 --- Mode Pos false --- Enable Axis TRUE --- CancelTraversing TRUE --- Intermediate Stop false --- Positive false --- Negative false --- Jog1 false --- Jog2 false --- AckError false --- Execute Mode 0 --- Position 0 --- Velocity 100 --- OverV 100 --- OverAcc false --- transfer_type 276 *md-dev-驱动_1~百川自定义报文_PZD-30_10" 设备模块硬件标识符 ENO Axis Enabled --- false Axis Pos Ok --- false Axis Ref --- false Axis Warn --- false Axis Alarm --- false Axis Error --- false Lockout --- false ActVelocity --- 0 ActPosition --- 0 ActMode --- 0 ActWarn --- 16#0 ActAlarm --- 16#0 ActFault --- 16#0 Error --- 0 Status --- 16#0 </pre>

二、使用“报文 111”控制时，可以使用“SINA_POS” 功能块进行控制。

功能块名称	引脚
Sinapos	<pre> %DB8 "SinaPos_DB" SinaPos EN 0 --- Mode Pos 0 --- Enable Axis 1 --- CancelTraversing 1 --- Intermediate Stop 0 --- Positive 0 --- Negative 0 --- Jog1 0 --- Jog2 0 --- FlyRef 0 --- AckError 0 --- Execute Mode 0 --- Position 0 --- Velocity 100 --- OverV 100 --- OverAcc 100 --- OverDec 16#0000_0003 --- ConfigEPos 276 *md-dev-驱动_1~西门子报文_111_PZD-12_12" HWIDSTW 276 *md-dev-驱动_1~西门子报文_111_PZD-12_12" HWIDZSW ENO Axis Enabled --- 0 Axis Pos Ok --- 0 Axis SpFixed --- 0 Axis Ref --- 0 Axis Warn --- 0 Axis Error --- 0 Lockout --- 0 ActVelocity --- 0 ActPosition --- 0 ActMode --- 0 EPosZSW1 --- 0 EPosZSW2 --- 0 ActWarn --- 0 ActFault --- 0 Error --- 0 Status --- 0 DiagId --- 0 </pre>

8.1.5.2 查看信息

8.1.5.2.1 设备模块硬件标识符

点击设备 -> 点击设备视图



点击 Module_1 -> 属性 -> 系统常数 -> 查看该子模块名称及硬件标识符 后续需要用到

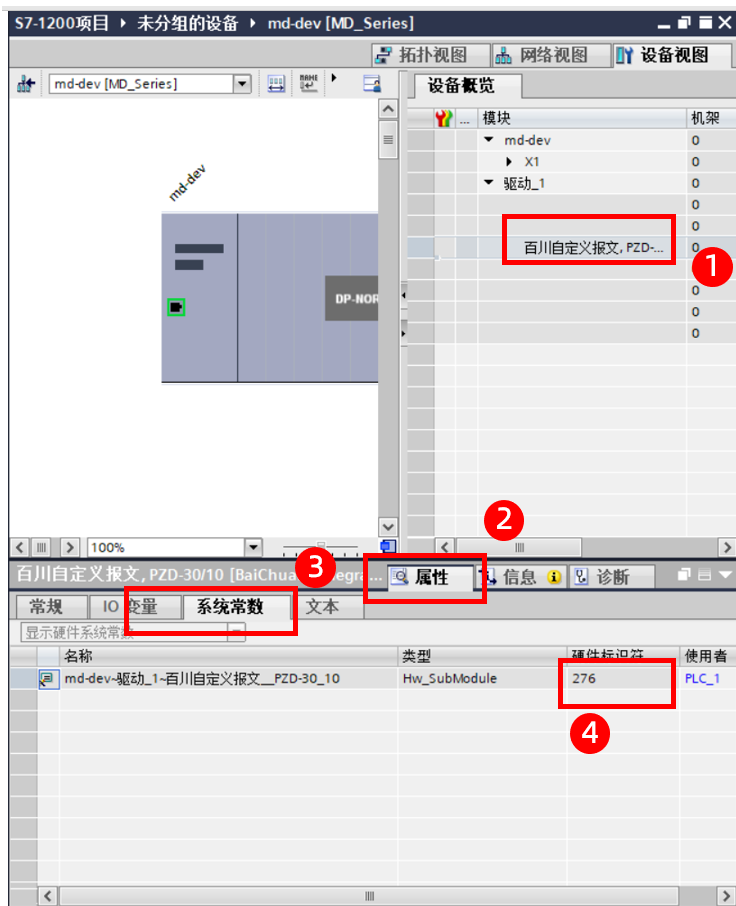

8.1.5.2.2 I/O 周期

PROFINET I/O 周期是指 PLC 作为 PROFINET 主站与从站设备之间周期性交换输入/输出数据的时间间隔（单位为毫秒）。

以下是查看组态设备的 I/O 周期时间步骤。

点击设备 -> 点击设备视图



点击 IO 周期 -> 查看该设备及的 **IO 周期更新时间**

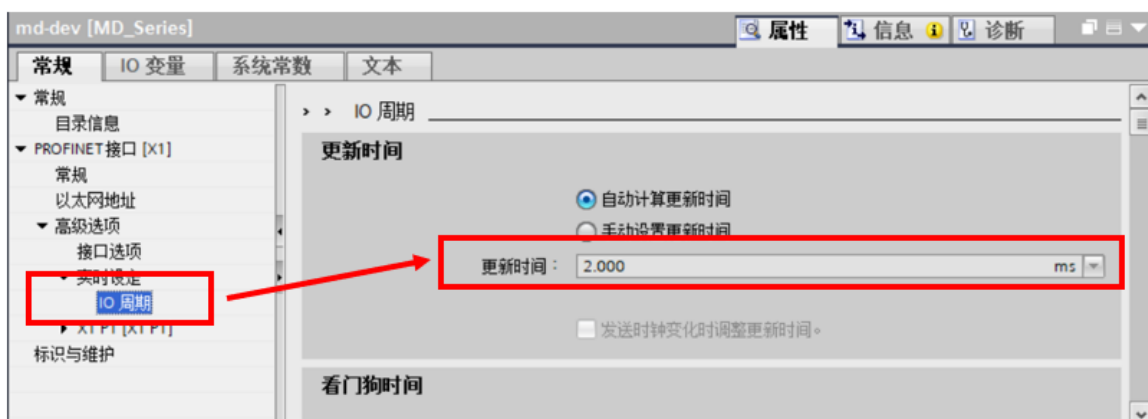

8.1.5.2.3 设备 I/O 映射区

点击设备 -> 点击设备视图 -> 查看分配的输入输出地址。

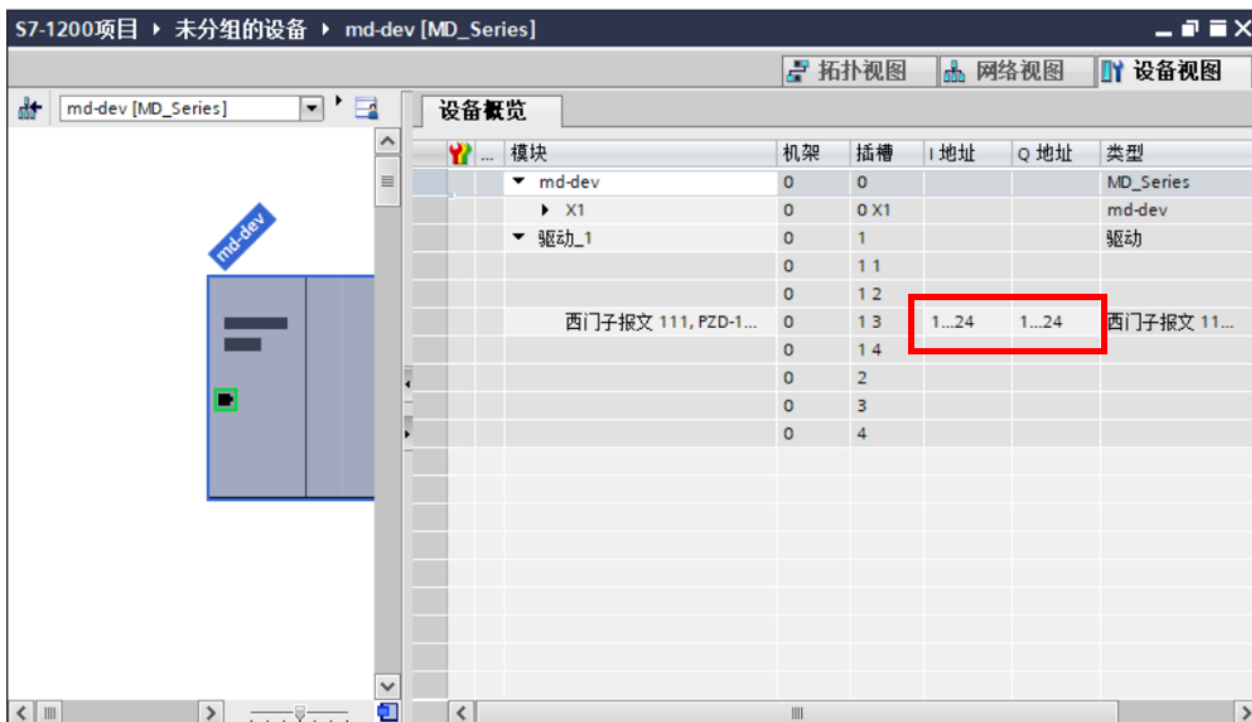

8.1.5.3 厂家报文使用方法

8.1.5.3.1 导入源文件

外部源文件 -> 添加新的外部文件 -> XXXX.scl -> 打开

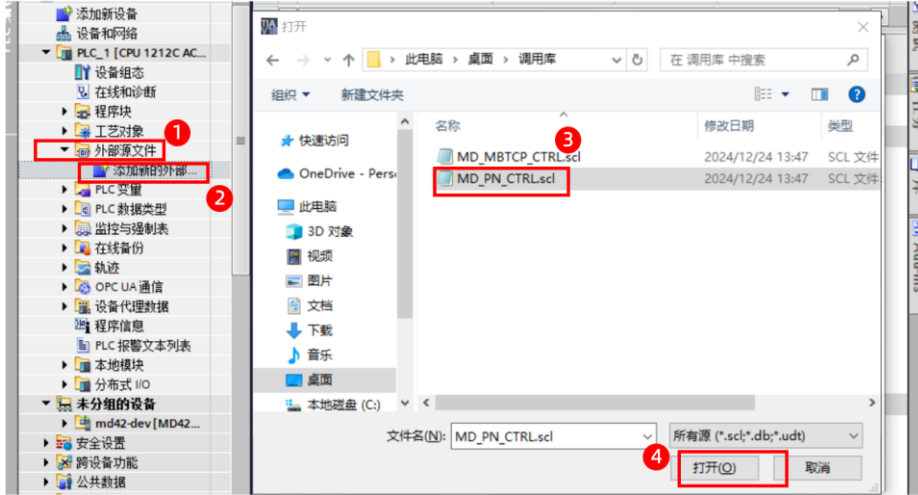

处于在线模式下时 应该先转至离线 -> 右键 XXXX.scl -> 从源生成块

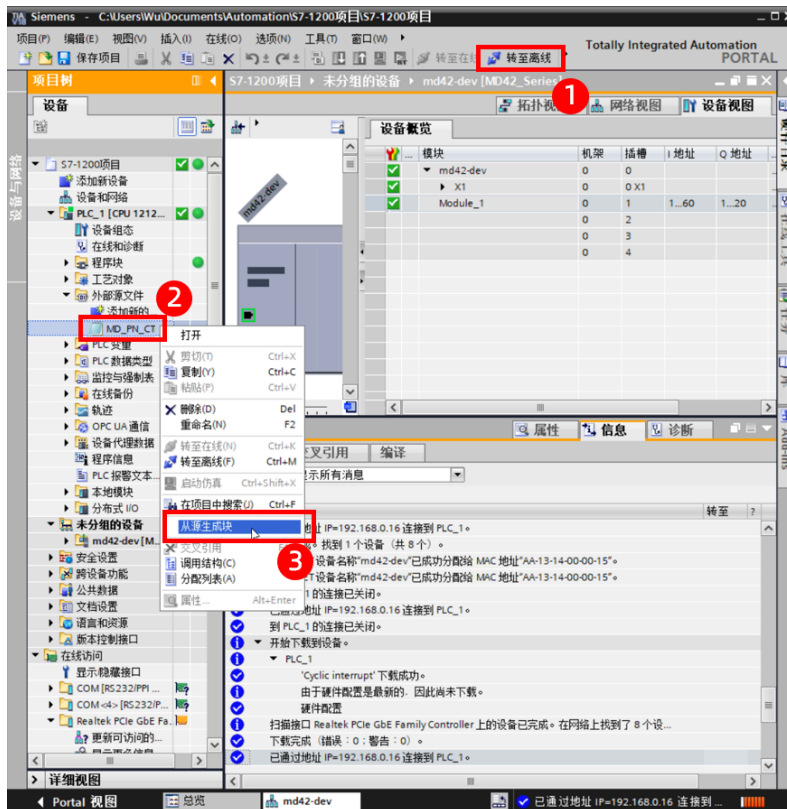

8.1.5.3.2 调用生成块

将生成的块拖入程序段中

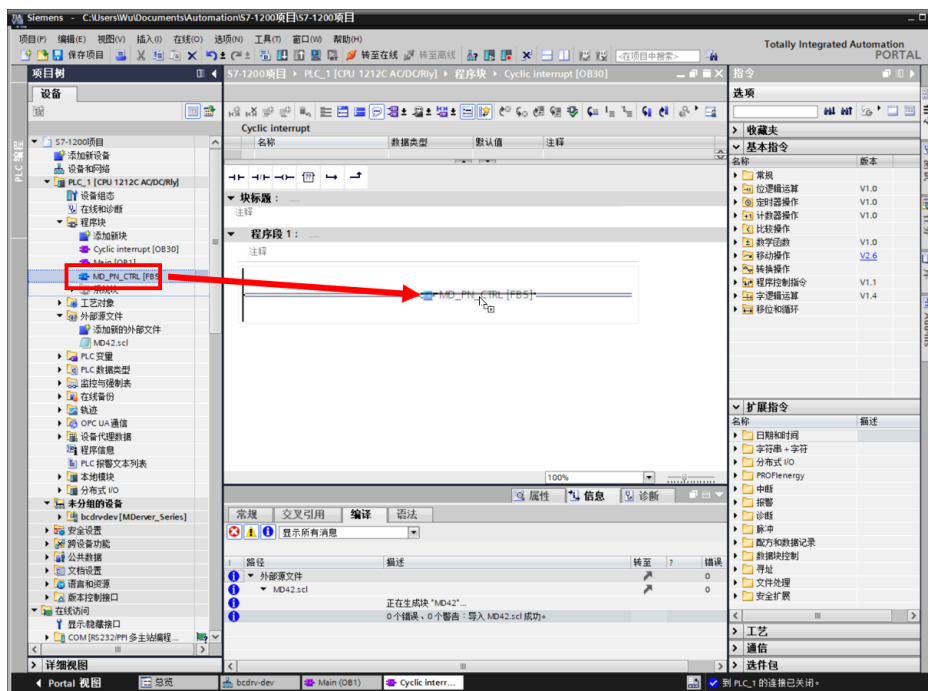

可修改名称 -> 确定



8.1.5.3.3 MD_PN_CTRL.scl

MD_PN_CTRL.scl 文件所生成的块如下：

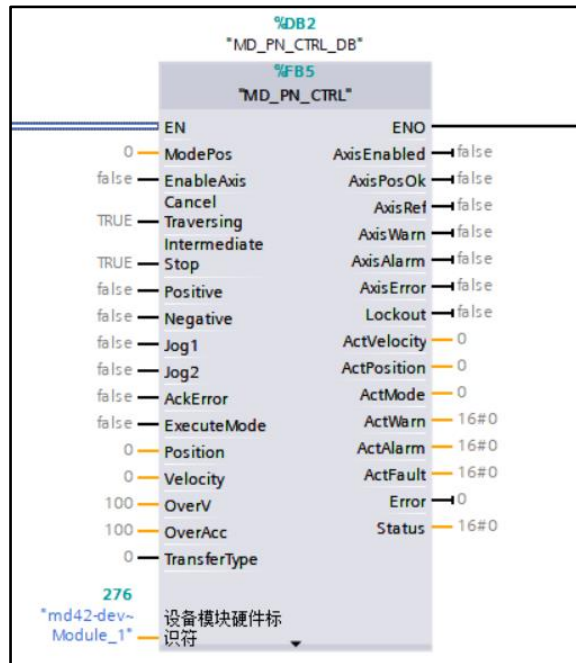

MD_PN_CTRL 块是 MD_PN 块的扩展，增加了输入输出引脚。通过控制这些输入输出引脚，可以实现对电机的控制。

鼠标放在块的输入输出引脚可显示注释。



8.1.5.3.3.1 块接口说明

8.1.5.3.3.1.1 输入接口

MD_PN_CTRL 的输入接口			
输入信号	类型	默认值	含义
ModePos	Int	0	运动模式: 1=相对位置模式 2=绝对位置模式 3=速度模式 4=主动回零模式 5=零点设置模式 6=程序步模式 7=点动模式 8=寸动模式
EnableAxis	Bool	FALSE	轴使能
CancelTraversing	Bool	TRUE	取消任务: 0=取消当前的运行任务 1=不取消当前的运行任务
IntermediateStop	Bool	TRUE	暂停任务: 0 = 暂停当前运行任务 1 = 不暂停当前运行任务
Positive	Bool	FALSE	正向 1 = 激活正向旋转, 0 = 未激活正向旋转 仅在速度模式有效
Negative	Bool	FALSE	负向 1 = 激活负向旋转, 0 = 未激活负向旋转 仅在速度模式有效
Jog1	Bool	FALSE	JOG+ 1 = 激活正向点/寸动, 0 = 未激活正向点/寸动
Jog2	Bool	FALSE	JOG- 1 = 激活负向点/寸动, 0 = 未激活负向点/寸动
AckError	Bool	FALSE	确认错误 1 = 确认错误有效 0 = 确认错误无效
ExecuteMode	Bool	FALSE	激活运行作业,不能和轴使能在同一个 PLC 扫描周期内进行动作触发
Position	DInt	0 [lu]	设定位置(lu)
Velocity	DInt	0 [lu/s]	设定速度(lu/s)
OverV	Int	100 [%]	所有运行模式的速度倍率有效: 0-199%
OverAcc	Int	100 [%]	加速度倍率有效 0-100%, 不适用于主动回零、点动及寸动模式
TransferType	Bool	0	传输方式: 0=单步传输 (通过<ExecuteMode>上升沿接收新的设定值) 1=连续传输 (立即接收新的设定值)

设备模块硬件标识符	HW_SUBMODULE	0	设备模块硬件标识符： 设备和网络->要控制的设备->属性->系统常数-> Hw_SubModule(XXX~ 驱动_1~百川自定义报文_PZD-30_10)的值 详见 设备模块硬件标识符
-----------	--------------	---	--

8.1.5.3.3.1.2 输出接口

MD_PN_CTRL 的输出接口			
输出信号	类型	默认值	含义
AxisEnabled	Bool	FALSE	轴已经使能
AxisPosOk	Bool	FALSE	已到达轴目标位置(斜坡位置与实际位置同时到达)
AxisRef	Bool	FALSE	原点设置完成 0=零点未设置 1=零点已设置
AxisWarn	Bool	FALSE	轴警告标识 0=无警告 1=有警告
not_homed	Bool	FALSE	警告：未回零点（零点未设置）
positive_limit_switch_approached	Bool	FALSE	警告：到达正限位
negative_limit_switch_approached	Bool	FALSE	警告：到达负限位
soft_positive_limit_approached	Bool	FALSE	警告：到达软正限位
soft_negative_limit_approached	Bool	FALSE	警告：到达软负限位
drv_otpw	Bool	FALSE	警告：驱动电路高温预警（120°C）
no_calibration	Bool	FALSE	警告：电机未校准
AxisAlarm	Bool	FALSE	轴报警标识 0=无报警 1=有报警
limit_approached	Bool	FALSE	报警：到达（软/硬）限位
AxisError	Bool	FALSE	轴故障标识 0=无故障 1=有故障
emergency_stop_activated	Bool	FALSE	故障：急停已激活
excessive_following_error	Bool	FALSE	故障：跟随误差过大
stall	Bool	FALSE	故障：电机发生堵转
error_no_calibration	Bool	FALSE	故障：电机未校准
drv_over_current	Bool	FALSE	故障：电机过流
drv_open_circuit	Bool	FALSE	故障：电机开路
drv_over_temperature	Bool	FALSE	故障：驱动电路过温（150°C）
Lockout	Bool	FALSE	无
ActVelocity	DInt	0	当前速度(经滤波的编码器值，单位： lu/s)
ActPosition	DInt	0	当前位置(编码器值，单位： lu)
ActMode	Int	0	当前模式
ActWarn	Word	16#0	当前警告字
ActAlarm	Word	16#0	当前报警字
ActFault	Word	16#0	当前故障字
Error	Bool	FALSE	1=块调用错误

Status	Word	16#0	块状态: 16#7002:无错误 16#8202:运行模式值超程 16#8203:速度/加速度值超程 16#8600:读取数据错误 16#8601:写入数据错误
--------	------	------	---

8.1.5.3.3.2 关联控制对象

必要参数设定																															
步骤	图示																														
<p>1、确认控制对象</p> <p>查看你要控制的设备的硬件标识符。</p> <p>设备模块硬件标识符</p> <p>设备和网络->要控制的设备->属性->系统常数->Hw_SubModule(XXX~驱动_1~百川自定义报文_PZD-30_10)的值图示中为 276</p>	 <table border="1"> <thead> <tr> <th>名称</th> <th>类型</th> <th>硬件标识符</th> <th>使用者</th> <th>注释</th> </tr> </thead> <tbody> <tr> <td>md42-dev-X1~X1_P1</td> <td>Hw_Interface</td> <td>274</td> <td>PLC_1</td> <td></td> </tr> <tr> <td>md42-dev-X1</td> <td>Hw_Interface</td> <td>273</td> <td>PLC_1</td> <td></td> </tr> <tr> <td>md42-dev-Proxy</td> <td>Hw_SubModule</td> <td>272</td> <td>PLC_1</td> <td></td> </tr> <tr> <td>md42-dev-Head</td> <td>Hw_SubModule</td> <td>275</td> <td>PLC_1</td> <td></td> </tr> <tr style="border: 2px solid red;"> <td>md42-dev-Module_1</td> <td>Hw_SubModule</td> <td>276</td> <td>PLC_1</td> <td></td> </tr> </tbody> </table>	名称	类型	硬件标识符	使用者	注释	md42-dev-X1~X1_P1	Hw_Interface	274	PLC_1		md42-dev-X1	Hw_Interface	273	PLC_1		md42-dev-Proxy	Hw_SubModule	272	PLC_1		md42-dev-Head	Hw_SubModule	275	PLC_1		md42-dev-Module_1	Hw_SubModule	276	PLC_1	
名称	类型	硬件标识符	使用者	注释																											
md42-dev-X1~X1_P1	Hw_Interface	274	PLC_1																												
md42-dev-X1	Hw_Interface	273	PLC_1																												
md42-dev-Proxy	Hw_SubModule	272	PLC_1																												
md42-dev-Head	Hw_SubModule	275	PLC_1																												
md42-dev-Module_1	Hw_SubModule	276	PLC_1																												
<p>2、输入设备模块的硬件标识符</p> <p>将函数与指定的受控设备进行数据交互。</p>	 <p style="text-align: center;">%DB1 "MD_PN_CTRL_DB" %FB1 "MD_PN_CTRL"</p> <p>EN — ENO — ModePos — Axis Enabled — EnableAxis — Axis Pos Ok — CancelTraversing — Axis Ref — IntermediateStop — Axis Warn — Positive — Axis Alarm — Negative — Axis Error — Jog1 — Lockout — Jog2 — ActVelocity — AckError — ActPosition — ExecuteMode — ActMode — Position — ActWarn — Velocity — ActAlarm — OverV — ActFault — OverAcc — Error — TransferType — Status —</p> <p>② 276 设备模块硬件标识符 "md42-dev-Module_1"</p>																														

8.1.5.3.3.2 绝对定位模式

绝对位置模式	
步骤	图示
1、检查 AxisRef 等于 TRUE 确认轴已回零。设备绝对位置模式需要零点作为的参考点。	
2、ModePos = 2 运动模式切换到绝对位置模式。	
3、CancelTraversing = TRUE 让设备不暂停任务。	
4、IntermediateStop = TRUE 让设备不取消任务。	
5、Position = 5000 确定绝对位置移动的位置，单位为 lu。	
6、Velocity = 5000 确定绝对位置移动的速度，单位为 lu/s。	
7、EnableAxis=1 让电机使能。	
8、等待时间 X 确保参数传输完毕，X 应大于 2 倍数据周期时间。IO 周期时间参考 I/O 周期	
9、ExecuteMode = TRUE 该信号上升沿时启动任务,设备按照设定的位置和速度执行绝对位置运动。	

8.1.5.3.3.3 速度模式

速度模式	
步骤	图示
1、ModePos = 3 运动模式切换到速度模式。	
2、CancelTraversing = TRUE 让设备不暂停任务。	
3、IntermediateStop = TRUE 让设备不取消任务。	
4、Velocity = 5000 确定速度模式移动的速度，单位为 lu/s。	
5、Positive = TRUE 确认旋转方向为正方向。	
6、EnableAxis=1 让电机使能。	
7、等待时间 X 确保参数传输完毕，X 应大于 2 倍数据周期时间。IO 周期时间参考 I/O 周期	
8、ExecuteMode = TRUE 该信号上升沿时启动任务,设备按照设定的速度执行速度模式运动。	

8.1.5.3.3.3.4 主动回零模式

8.1.5.3.3.3.4.1 扭矩回零

主动回零模式-使用扭矩回零方式	
步骤	图示
1、参数 limit_protect_enable = 0 关闭硬限位功能。	<p>Parameter table showing limit_protect_enable = 0. The table lists various parameters with their values and descriptions. Red circles highlight the parameter value.</p>
2、参数 homing_method = 0 使用扭矩回零。	<p>Parameter table showing homing_method = 0. The table lists various parameters with their values and descriptions. Red circles highlight the parameter value.</p>
3、参数 homing_use_z_signal = 0 关闭 z 信号辅助回零。	<p>Parameter table showing homing_use_z_signal = 0. The table lists various parameters with their values and descriptions. Red circles highlight the parameter value.</p>
4、参数 homing_torque_threshold = 98 扭矩回零阈值设置为 98%。	<p>Parameter table showing homing_torque_threshold = 98. The table lists various parameters with their values and descriptions. Red circles highlight the parameter value.</p>
5、ModePos = 4 运动模式切换到主动回零模式。	<p>Parameter table showing ModePos = 4. The table lists various parameters with their values and descriptions. Red circles highlight the parameter value.</p>
6、CancelTraversing = TRUE 让设备不暂停任务。	<p>Parameter table showing CancelTraversing = TRUE. The table lists various parameters with their values and descriptions. Red circles highlight the parameter value.</p>
7、IntermediateStop = TRUE 让设备不取消任务。	<p>Parameter table showing IntermediateStop = TRUE. The table lists various parameters with their values and descriptions. Red circles highlight the parameter value.</p>
8、EnableAxis=1 让电机使能。	<p>Parameter table showing EnableAxis = 1. The table lists various parameters with their values and descriptions. Red circles highlight the parameter value.</p>
9、等待时间 X 确保参数传输完毕, X 应大于 2 倍数据周期时间。IO 周期时间参考 I/O 周期	<p>Parameter table showing X = 276. The table lists various parameters with their values and descriptions. Red circles highlight the parameter value.</p>
10、ExecuteMode = TRUE 该信号上升沿时启动任务,设备按照参数表设定的回零参数执行主动回零。	<p>Ladder logic diagram for active homing. It shows a normally open contact labeled '%M1.2' with the text '*Always TRUE*' next to it. This contact is connected to the EN input of a coil labeled '%DB1 MD_PN_CTRL'. The coil has two outputs: '%B1 MD_PN_CTRL' and '%B1 MD_PN_CTRL_DB'. Below the diagram, there is a list of parameters and their values: ModePos (4), EnableAxis (TRUE), CancelTraversing (TRUE), IntermediateStop (TRUE), Positive (false), Negative (false), Jog1 (false), Jog2 (false), AckError (false), ExecuteMode (TRUE), Position (0), Velocity (0), OverV (100), OverAcc (100), TransferType (0), and Status (276). A note at the bottom indicates '*md42-dev-Module_1*' as the device module hardware identifier.</p>

8.1.5.3.3.3.4.2 扭矩回零+编码器 z 信号

主动回零模式-使用扭矩回零方式+编码器 z 信号																																																																																																																																																																																																																																																																																																																																																																																																																																								
步骤	图示																																																																																																																																																																																																																																																																																																																																																																																																																																							
1、参数 limit_protect_enable = 0 关闭硬限位功能。	<table border="1"> <thead> <tr> <th>参数号</th> <th>参数名</th> <th>参数值</th> <th>数据类型</th> <th>取值范围</th> <th>出厂值</th> <th>最小值</th> <th>最大值</th> <th>单位</th> </tr> </thead> <tbody> <tr><td>62</td><td>速度限制</td><td>limit_velocity</td><td>速度</td><td>100</td><td>100</td><td>10</td><td>100</td><td>27°/min</td></tr> <tr><td>64</td><td>加速度限制</td><td>limit_acceleration</td><td>加速度</td><td>10</td><td>10</td><td>10</td><td>10</td><td>g</td></tr> <tr><td>66</td><td>速度限制时间</td><td>limit_velocity_time</td><td>速度限制时间</td><td>10</td><td>10</td><td>10</td><td>10</td><td>ms</td></tr> <tr><td>68</td><td>加速度限制时间</td><td>limit_acceleration_time</td><td>加速度限制时间</td><td>10</td><td>10</td><td>10</td><td>10</td><td>ms</td></tr> <tr><td>70</td><td>速度限制</td><td>limit_velocity</td><td>速度</td><td>2</td><td>2</td><td>2</td><td>2</td><td>rpm</td></tr> <tr><td>72</td><td>速度限制时间</td><td>limit_velocity_time</td><td>速度限制时间</td><td>10</td><td>10</td><td>10</td><td>10</td><td>ms</td></tr> <tr><td>74</td><td>速度限制</td><td>limit_velocity</td><td>速度</td><td>100</td><td>100</td><td>10</td><td>100</td><td>rpm</td></tr> <tr><td>76</td><td>速度限制时间</td><td>limit_velocity_time</td><td>速度限制时间</td><td>10</td><td>10</td><td>10</td><td>10</td><td>ms</td></tr> <tr><td>78</td><td>速度限制</td><td>limit_velocity</td><td>速度</td><td>100</td><td>100</td><td>10</td><td>100</td><td>rpm</td></tr> <tr><td>80</td><td>速度限制时间</td><td>limit_velocity_time</td><td>速度限制时间</td><td>10</td><td>10</td><td>10</td><td>10</td><td>ms</td></tr> <tr><td>82</td><td>速度限制</td><td>limit_velocity</td><td>速度</td><td>100</td><td>100</td><td>10</td><td>100</td><td>rpm</td></tr> <tr><td>84</td><td>速度限制时间</td><td>limit_velocity_time</td><td>速度限制时间</td><td>10</td><td>10</td><td>10</td><td>10</td><td>ms</td></tr> <tr><td>86</td><td>速度限制</td><td>limit_velocity</td><td>速度</td><td>100</td><td>100</td><td>10</td><td>100</td><td>rpm</td></tr> <tr><td>88</td><td>速度限制时间</td><td>limit_velocity_time</td><td>速度限制时间</td><td>10</td><td>10</td><td>10</td><td>10</td><td>ms</td></tr> <tr><td>90</td><td>速度限制</td><td>limit_velocity</td><td>速度</td><td>100</td><td>100</td><td>10</td><td>100</td><td>rpm</td></tr> <tr><td>92</td><td>速度限制时间</td><td>limit_velocity_time</td><td>速度限制时间</td><td>10</td><td>10</td><td>10</td><td>10</td><td>ms</td></tr> <tr><td>94</td><td>速度限制</td><td>limit_velocity</td><td>速度</td><td>100</td><td>100</td><td>10</td><td>100</td><td>rpm</td></tr> <tr><td>96</td><td>速度限制时间</td><td>limit_velocity_time</td><td>速度限制时间</td><td>10</td><td>10</td><td>10</td><td>10</td><td>ms</td></tr> <tr><td>98</td><td>速度限制</td><td>limit_velocity</td><td>速度</td><td>100</td><td>100</td><td>10</td><td>100</td><td>rpm</td></tr> <tr><td>100</td><td>速度限制时间</td><td>limit_velocity_time</td><td>速度限制时间</td><td>10</td><td>10</td><td>10</td><td>10</td><td>ms</td></tr> <tr><td>102</td><td>速度限制</td><td>limit_velocity</td><td>速度</td><td>100</td><td>100</td><td>10</td><td>100</td><td>rpm</td></tr> <tr><td>104</td><td>速度限制时间</td><td>limit_velocity_time</td><td>速度限制时间</td><td>10</td><td>10</td><td>10</td><td>10</td><td>ms</td></tr> <tr><td>106</td><td>速度限制</td><td>limit_velocity</td><td>速度</td><td>100</td><td>100</td><td>10</td><td>100</td><td>rpm</td></tr> <tr><td>108</td><td>速度限制时间</td><td>limit_velocity_time</td><td>速度限制时间</td><td>10</td><td>10</td><td>10</td><td>10</td><td>ms</td></tr> <tr><td>110</td><td>速度限制</td><td>limit_velocity</td><td>速度</td><td>100</td><td>100</td><td>10</td><td>100</td><td>rpm</td></tr> <tr><td>112</td><td>速度限制时间</td><td>limit_velocity_time</td><td>速度限制时间</td><td>10</td><td>10</td><td>10</td><td>10</td><td>ms</td></tr> <tr><td>114</td><td>速度限制</td><td>limit_velocity</td><td>速度</td><td>100</td><td>100</td><td>10</td><td>100</td><td>rpm</td></tr> <tr><td>116</td><td>速度限制时间</td><td>limit_velocity_time</td><td>速度限制时间</td><td>10</td><td>10</td><td>10</td><td>10</td><td>ms</td></tr> <tr><td>118</td><td>速度限制</td><td>limit_velocity</td><td>速度</td><td>100</td><td>100</td><td>10</td><td>100</td><td>rpm</td></tr> <tr><td>120</td><td>速度限制时间</td><td>limit_velocity_time</td><td>速度限制时间</td><td>10</td><td>10</td><td>10</td><td>10</td><td>ms</td></tr> <tr><td>122</td><td>速度限制</td><td>limit_velocity</td><td>速度</td><td>100</td><td>100</td><td>10</td><td>100</td><td>rpm</td></tr> <tr><td>124</td><td>速度限制时间</td><td>limit_velocity_time</td><td>速度限制时间</td><td>10</td><td>10</td><td>10</td><td>10</td><td>ms</td></tr> <tr><td>126</td><td>速度限制</td><td>limit_velocity</td><td>速度</td><td>100</td><td>100</td><td>10</td><td>100</td><td>rpm</td></tr> <tr><td>128</td><td>速度限制时间</td><td>limit_velocity_time</td><td>速度限制时间</td><td>10</td><td>10</td><td>10</td><td>10</td><td>ms</td></tr> <tr><td>130</td><td>速度限制</td><td>limit_velocity</td><td>速度</td><td>100</td><td>100</td><td>10</td><td>100</td><td>rpm</td></tr> <tr><td>132</td><td>速度限制时间</td><td>limit_velocity_time</td><td>速度限制时间</td><td>10</td><td>10</td><td>10</td><td>10</td><td>ms</td></tr> <tr><td>134</td><td>速度限制</td><td>limit_velocity</td><td>速度</td><td>100</td><td>100</td><td>10</td><td>100</td><td>rpm</td></tr> <tr><td>136</td><td>速度限制时间</td><td>limit_velocity_time</td><td>速度限制时间</td><td>10</td><td>10</td><td>10</td><td>10</td><td>ms</td></tr> <tr><td>138</td><td>速度限制</td><td>limit_velocity</td><td>速度</td><td>100</td><td>100</td><td>10</td><td>100</td><td>rpm</td></tr> <tr><td>140</td><td>速度限制时间</td><td>limit_velocity_time</td><td>速度限制时间</td><td>10</td><td>10</td><td>10</td><td>10</td><td>ms</td></tr> <tr><td>142</td><td>速度限制</td><td>limit_velocity</td><td>速度</td><td>100</td><td>100</td><td>10</td><td>100</td><td>rpm</td></tr> <tr><td>144</td><td>速度限制时间</td><td>limit_velocity_time</td><td>速度限制时间</td><td>10</td><td>10</td><td>10</td><td>10</td><td>ms</td></tr> <tr><td>146</td><td>速度限制</td><td>limit_velocity</td><td>速度</td><td>100</td><td>100</td><td>10</td><td>100</td><td>rpm</td></tr> <tr><td>148</td><td>速度限制时间</td><td>limit_velocity_time</td><td>速度限制时间</td><td>10</td><td>10</td><td>10</td><td>10</td><td>ms</td></tr> <tr><td>150</td><td>速度限制</td><td>limit_velocity</td><td>速度</td><td>100</td><td>100</td><td>10</td><td>100</td><td>rpm</td></tr> <tr><td>152</td><td>速度限制时间</td><td>limit_velocity_time</td><td>速度限制时间</td><td>10</td><td>10</td><td>10</td><td>10</td><td>ms</td></tr> </tbody> </table>	参数号	参数名	参数值	数据类型	取值范围	出厂值	最小值	最大值	单位	62	速度限制	limit_velocity	速度	100	100	10	100	27°/min	64	加速度限制	limit_acceleration	加速度	10	10	10	10	g	66	速度限制时间	limit_velocity_time	速度限制时间	10	10	10	10	ms	68	加速度限制时间	limit_acceleration_time	加速度限制时间	10	10	10	10	ms	70	速度限制	limit_velocity	速度	2	2	2	2	rpm	72	速度限制时间	limit_velocity_time	速度限制时间	10	10	10	10	ms	74	速度限制	limit_velocity	速度	100	100	10	100	rpm	76	速度限制时间	limit_velocity_time	速度限制时间	10	10	10	10	ms	78	速度限制	limit_velocity	速度	100	100	10	100	rpm	80	速度限制时间	limit_velocity_time	速度限制时间	10	10	10	10	ms	82	速度限制	limit_velocity	速度	100	100	10	100	rpm	84	速度限制时间	limit_velocity_time	速度限制时间	10	10	10	10	ms	86	速度限制	limit_velocity	速度	100	100	10	100	rpm	88	速度限制时间	limit_velocity_time	速度限制时间	10	10	10	10	ms	90	速度限制	limit_velocity	速度	100	100	10	100	rpm	92	速度限制时间	limit_velocity_time	速度限制时间	10	10	10	10	ms	94	速度限制	limit_velocity	速度	100	100	10	100	rpm	96	速度限制时间	limit_velocity_time	速度限制时间	10	10	10	10	ms	98	速度限制	limit_velocity	速度	100	100	10	100	rpm	100	速度限制时间	limit_velocity_time	速度限制时间	10	10	10	10	ms	102	速度限制	limit_velocity	速度	100	100	10	100	rpm	104	速度限制时间	limit_velocity_time	速度限制时间	10	10	10	10	ms	106	速度限制	limit_velocity	速度	100	100	10	100	rpm	108	速度限制时间	limit_velocity_time	速度限制时间	10	10	10	10	ms	110	速度限制	limit_velocity	速度	100	100	10	100	rpm	112	速度限制时间	limit_velocity_time	速度限制时间	10	10	10	10	ms	114	速度限制	limit_velocity	速度	100	100	10	100	rpm	116	速度限制时间	limit_velocity_time	速度限制时间	10	10	10	10	ms	118	速度限制	limit_velocity	速度	100	100	10	100	rpm	120	速度限制时间	limit_velocity_time	速度限制时间	10	10	10	10	ms	122	速度限制	limit_velocity	速度	100	100	10	100	rpm	124	速度限制时间	limit_velocity_time	速度限制时间	10	10	10	10	ms	126	速度限制	limit_velocity	速度	100	100	10	100	rpm	128	速度限制时间	limit_velocity_time	速度限制时间	10	10	10	10	ms	130	速度限制	limit_velocity	速度	100	100	10	100	rpm	132	速度限制时间	limit_velocity_time	速度限制时间	10	10	10	10	ms	134	速度限制	limit_velocity	速度	100	100	10	100	rpm	136	速度限制时间	limit_velocity_time	速度限制时间	10	10	10	10	ms	138	速度限制	limit_velocity	速度	100	100	10	100	rpm	140	速度限制时间	limit_velocity_time	速度限制时间	10	10	10	10	ms	142	速度限制	limit_velocity	速度	100	100	10	100	rpm	144	速度限制时间	limit_velocity_time	速度限制时间	10	10	10	10	ms	146	速度限制	limit_velocity	速度	100	100	10	100	rpm	148	速度限制时间	limit_velocity_time	速度限制时间	10	10	10	10	ms	150	速度限制	limit_velocity	速度	100	100	10	100	rpm	152	速度限制时间	limit_velocity_time	速度限制时间	10	10	10	10	ms
参数号	参数名	参数值	数据类型	取值范围	出厂值	最小值	最大值	单位																																																																																																																																																																																																																																																																																																																																																																																																																																
62	速度限制	limit_velocity	速度	100	100	10	100	27°/min																																																																																																																																																																																																																																																																																																																																																																																																																																
64	加速度限制	limit_acceleration	加速度	10	10	10	10	g																																																																																																																																																																																																																																																																																																																																																																																																																																
66	速度限制时间	limit_velocity_time	速度限制时间	10	10	10	10	ms																																																																																																																																																																																																																																																																																																																																																																																																																																
68	加速度限制时间	limit_acceleration_time	加速度限制时间	10	10	10	10	ms																																																																																																																																																																																																																																																																																																																																																																																																																																
70	速度限制	limit_velocity	速度	2	2	2	2	rpm																																																																																																																																																																																																																																																																																																																																																																																																																																
72	速度限制时间	limit_velocity_time	速度限制时间	10	10	10	10	ms																																																																																																																																																																																																																																																																																																																																																																																																																																
74	速度限制	limit_velocity	速度	100	100	10	100	rpm																																																																																																																																																																																																																																																																																																																																																																																																																																
76	速度限制时间	limit_velocity_time	速度限制时间	10	10	10	10	ms																																																																																																																																																																																																																																																																																																																																																																																																																																
78	速度限制	limit_velocity	速度	100	100	10	100	rpm																																																																																																																																																																																																																																																																																																																																																																																																																																
80	速度限制时间	limit_velocity_time	速度限制时间	10	10	10	10	ms																																																																																																																																																																																																																																																																																																																																																																																																																																
82	速度限制	limit_velocity	速度	100	100	10	100	rpm																																																																																																																																																																																																																																																																																																																																																																																																																																
84	速度限制时间	limit_velocity_time	速度限制时间	10	10	10	10	ms																																																																																																																																																																																																																																																																																																																																																																																																																																
86	速度限制	limit_velocity	速度	100	100	10	100	rpm																																																																																																																																																																																																																																																																																																																																																																																																																																
88	速度限制时间	limit_velocity_time	速度限制时间	10	10	10	10	ms																																																																																																																																																																																																																																																																																																																																																																																																																																
90	速度限制	limit_velocity	速度	100	100	10	100	rpm																																																																																																																																																																																																																																																																																																																																																																																																																																
92	速度限制时间	limit_velocity_time	速度限制时间	10	10	10	10	ms																																																																																																																																																																																																																																																																																																																																																																																																																																
94	速度限制	limit_velocity	速度	100	100	10	100	rpm																																																																																																																																																																																																																																																																																																																																																																																																																																
96	速度限制时间	limit_velocity_time	速度限制时间	10	10	10	10	ms																																																																																																																																																																																																																																																																																																																																																																																																																																
98	速度限制	limit_velocity	速度	100	100	10	100	rpm																																																																																																																																																																																																																																																																																																																																																																																																																																
100	速度限制时间	limit_velocity_time	速度限制时间	10	10	10	10	ms																																																																																																																																																																																																																																																																																																																																																																																																																																
102	速度限制	limit_velocity	速度	100	100	10	100	rpm																																																																																																																																																																																																																																																																																																																																																																																																																																
104	速度限制时间	limit_velocity_time	速度限制时间	10	10	10	10	ms																																																																																																																																																																																																																																																																																																																																																																																																																																
106	速度限制	limit_velocity	速度	100	100	10	100	rpm																																																																																																																																																																																																																																																																																																																																																																																																																																
108	速度限制时间	limit_velocity_time	速度限制时间	10	10	10	10	ms																																																																																																																																																																																																																																																																																																																																																																																																																																
110	速度限制	limit_velocity	速度	100	100	10	100	rpm																																																																																																																																																																																																																																																																																																																																																																																																																																
112	速度限制时间	limit_velocity_time	速度限制时间	10	10	10	10	ms																																																																																																																																																																																																																																																																																																																																																																																																																																
114	速度限制	limit_velocity	速度	100	100	10	100	rpm																																																																																																																																																																																																																																																																																																																																																																																																																																
116	速度限制时间	limit_velocity_time	速度限制时间	10	10	10	10	ms																																																																																																																																																																																																																																																																																																																																																																																																																																
118	速度限制	limit_velocity	速度	100	100	10	100	rpm																																																																																																																																																																																																																																																																																																																																																																																																																																
120	速度限制时间	limit_velocity_time	速度限制时间	10	10	10	10	ms																																																																																																																																																																																																																																																																																																																																																																																																																																
122	速度限制	limit_velocity	速度	100	100	10	100	rpm																																																																																																																																																																																																																																																																																																																																																																																																																																
124	速度限制时间	limit_velocity_time	速度限制时间	10	10	10	10	ms																																																																																																																																																																																																																																																																																																																																																																																																																																
126	速度限制	limit_velocity	速度	100	100	10	100	rpm																																																																																																																																																																																																																																																																																																																																																																																																																																
128	速度限制时间	limit_velocity_time	速度限制时间	10	10	10	10	ms																																																																																																																																																																																																																																																																																																																																																																																																																																
130	速度限制	limit_velocity	速度	100	100	10	100	rpm																																																																																																																																																																																																																																																																																																																																																																																																																																
132	速度限制时间	limit_velocity_time	速度限制时间	10	10	10	10	ms																																																																																																																																																																																																																																																																																																																																																																																																																																
134	速度限制	limit_velocity	速度	100	100	10	100	rpm																																																																																																																																																																																																																																																																																																																																																																																																																																
136	速度限制时间	limit_velocity_time	速度限制时间	10	10	10	10	ms																																																																																																																																																																																																																																																																																																																																																																																																																																
138	速度限制	limit_velocity	速度	100	100	10	100	rpm																																																																																																																																																																																																																																																																																																																																																																																																																																
140	速度限制时间	limit_velocity_time	速度限制时间	10	10	10	10	ms																																																																																																																																																																																																																																																																																																																																																																																																																																
142	速度限制	limit_velocity	速度	100	100	10	100	rpm																																																																																																																																																																																																																																																																																																																																																																																																																																
144	速度限制时间	limit_velocity_time	速度限制时间	10	10	10	10	ms																																																																																																																																																																																																																																																																																																																																																																																																																																
146	速度限制	limit_velocity	速度	100	100	10	100	rpm																																																																																																																																																																																																																																																																																																																																																																																																																																
148	速度限制时间	limit_velocity_time	速度限制时间	10	10	10	10	ms																																																																																																																																																																																																																																																																																																																																																																																																																																
150	速度限制	limit_velocity	速度	100	100	10	100	rpm																																																																																																																																																																																																																																																																																																																																																																																																																																
152	速度限制时间	limit_velocity_time	速度限制时间	10	10	10	10	ms																																																																																																																																																																																																																																																																																																																																																																																																																																
2、参数 homing_method = 0 使用扭矩回零。																																																																																																																																																																																																																																																																																																																																																																																																																																								
3、参数 homing_use_z_signal = 1 开启 z 信号辅助回零。																																																																																																																																																																																																																																																																																																																																																																																																																																								
4、参数 homing_torque_threshold = 98 扭矩回零阈值设置为 98%。																																																																																																																																																																																																																																																																																																																																																																																																																																								
5、ModePos = 4 运动模式切换到主动回零模式。																																																																																																																																																																																																																																																																																																																																																																																																																																								
6、CancelTraversing = TRUE 让设备不暂停任务。																																																																																																																																																																																																																																																																																																																																																																																																																																								
7、IntermediateStop = TRUE 让设备不取消任务。																																																																																																																																																																																																																																																																																																																																																																																																																																								
8、EnableAxis=1 让电机使能。																																																																																																																																																																																																																																																																																																																																																																																																																																								
9、等待时间 X 确保参数传输完毕, X 应大于 2 倍数据周期时间。IO 周期时间参考 I/O 周期																																																																																																																																																																																																																																																																																																																																																																																																																																								
10、ExecuteMode = TRUE 该信号上升沿时启动任务,设备按照参数表设定的回零参数执行主动回零。																																																																																																																																																																																																																																																																																																																																																																																																																																								

8.1.5.3.3.3.4.4 硬限位+编码器 z 信号

主动回零模式-使用硬限位信号方式+编码器 z 信号																																																																																																																																																																																																																																																																																																																																																																																																																																																																																																																																																																																																																																																																																																																																																																																																																																																																																																																																																																																																																																																																																																																																																																																																																																																																																																																						
步骤	图示																																																																																																																																																																																																																																																																																																																																																																																																																																																																																																																																																																																																																																																																																																																																																																																																																																																																																																																																																																																																																																																																																																																																																																																																																																																																																																																					
1、参数 limit_protect_enable = 1 使能硬限位功能。	<table border="1"> <thead> <tr> <th>参数号</th> <th>描述名称</th> <th>参数名</th> <th>单位</th> <th>范围</th> <th>出厂值</th> <th>最小值</th> <th>最大值</th> <th>备注</th> </tr> </thead> <tbody> <tr><td>61</td><td>限位参数</td><td>limit_protect_enable</td><td>逻辑</td><td>0-1</td><td>0</td><td>0</td><td>1</td><td>使能硬限位</td></tr> <tr><td>62</td><td>限位参数</td><td>limit_protect_time</td><td>位置到限位时间</td><td>ms</td><td>10</td><td>10</td><td>10</td><td>40000</td></tr> <tr><td>63</td><td>限位参数</td><td>limit_protect_speed</td><td>速度到限位速度</td><td>mm</td><td>10</td><td>10</td><td>10</td><td>40000</td></tr> <tr><td>64</td><td>限位参数</td><td>limit_protect_acc</td><td>加速度到限位加速度</td><td>mm/s²</td><td>10</td><td>10</td><td>10</td><td>40000</td></tr> <tr><td>65</td><td>限位参数</td><td>limit_protect_jerk</td><td> jerk到限位jerk</td><td>mm/s³</td><td>2</td><td>2</td><td>2</td><td>40000</td></tr> <tr><td>66</td><td>限位参数</td><td>limit_protect_force</td><td>力到限位力</td><td>N</td><td>10</td><td>10</td><td>10</td><td>40000</td></tr> <tr><td>67</td><td>限位参数</td><td>limit_protect_torque</td><td>扭矩到限位扭矩</td><td>Nm</td><td>10</td><td>10</td><td>10</td><td>40000</td></tr> <tr><td>68</td><td>限位参数</td><td>limit_protect_current</td><td>电流到限位电流</td><td>A</td><td>10</td><td>10</td><td>10</td><td>40000</td></tr> <tr><td>69</td><td>限位参数</td><td>limit_protect_voltage</td><td>电压到限位电压</td><td>V</td><td>10</td><td>10</td><td>10</td><td>40000</td></tr> <tr><td>70</td><td>限位参数</td><td>limit_protect_temperature</td><td>温度到限位温度</td><td>°C</td><td>10</td><td>10</td><td>10</td><td>40000</td></tr> <tr><td>71</td><td>限位参数</td><td>limit_protect_position</td><td>位置到限位位置</td><td>mm</td><td>10</td><td>10</td><td>10</td><td>40000</td></tr> <tr><td>72</td><td>限位参数</td><td>limit_protect_speed</td><td>速度到限位速度</td><td>mm/s</td><td>10</td><td>10</td><td>10</td><td>40000</td></tr> <tr><td>73</td><td>限位参数</td><td>limit_protect_acc</td><td>加速度到限位加速度</td><td>mm/s²</td><td>10</td><td>10</td><td>10</td><td>40000</td></tr> <tr><td>74</td><td>限位参数</td><td>limit_protect_jerk</td><td> jerk到限位jerk</td><td>mm/s³</td><td>2</td><td>2</td><td>2</td><td>40000</td></tr> <tr><td>75</td><td>限位参数</td><td>limit_protect_force</td><td>力到限位力</td><td>N</td><td>10</td><td>10</td><td>10</td><td>40000</td></tr> <tr><td>76</td><td>限位参数</td><td>limit_protect_torque</td><td>扭矩到限位扭矩</td><td>Nm</td><td>10</td><td>10</td><td>10</td><td>40000</td></tr> <tr><td>77</td><td>限位参数</td><td>limit_protect_current</td><td>电流到限位电流</td><td>A</td><td>10</td><td>10</td><td>10</td><td>40000</td></tr> <tr><td>78</td><td>限位参数</td><td>limit_protect_voltage</td><td>电压到限位电压</td><td>V</td><td>10</td><td>10</td><td>10</td><td>40000</td></tr> <tr><td>79</td><td>限位参数</td><td>limit_protect_temperature</td><td>温度到限位温度</td><td>°C</td><td>10</td><td>10</td><td>10</td><td>40000</td></tr> <tr><td>80</td><td>限位参数</td><td>limit_protect_position</td><td>位置到限位位置</td><td>mm</td><td>10</td><td>10</td><td>10</td><td>40000</td></tr> <tr><td>81</td><td>限位参数</td><td>limit_protect_speed</td><td>速度到限位速度</td><td>mm/s</td><td>10</td><td>10</td><td>10</td><td>40000</td></tr> <tr><td>82</td><td>限位参数</td><td>limit_protect_acc</td><td>加速度到限位加速度</td><td>mm/s²</td><td>10</td><td>10</td><td>10</td><td>40000</td></tr> <tr><td>83</td><td>限位参数</td><td>limit_protect_jerk</td><td> jerk到限位jerk</td><td>mm/s³</td><td>2</td><td>2</td><td>2</td><td>40000</td></tr> <tr><td>84</td><td>限位参数</td><td>limit_protect_force</td><td>力到限位力</td><td>N</td><td>10</td><td>10</td><td>10</td><td>40000</td></tr> <tr><td>85</td><td>限位参数</td><td>limit_protect_torque</td><td>扭矩到限位扭矩</td><td>Nm</td><td>10</td><td>10</td><td>10</td><td>40000</td></tr> <tr><td>86</td><td>限位参数</td><td>limit_protect_current</td><td>电流到限位电流</td><td>A</td><td>10</td><td>10</td><td>10</td><td>40000</td></tr> <tr><td>87</td><td>限位参数</td><td>limit_protect_voltage</td><td>电压到限位电压</td><td>V</td><td>10</td><td>10</td><td>10</td><td>40000</td></tr> <tr><td>88</td><td>限位参数</td><td>limit_protect_temperature</td><td>温度到限位温度</td><td>°C</td><td>10</td><td>10</td><td>10</td><td>40000</td></tr> <tr><td>89</td><td>限位参数</td><td>limit_protect_position</td><td>位置到限位位置</td><td>mm</td><td>10</td><td>10</td><td>10</td><td>40000</td></tr> <tr><td>90</td><td>限位参数</td><td>limit_protect_speed</td><td>速度到限位速度</td><td>mm/s</td><td>10</td><td>10</td><td>10</td><td>40000</td></tr> <tr><td>91</td><td>限位参数</td><td>limit_protect_acc</td><td>加速度到限位加速度</td><td>mm/s²</td><td>10</td><td>10</td><td>10</td><td>40000</td></tr> <tr><td>92</td><td>限位参数</td><td>limit_protect_jerk</td><td> jerk到限位jerk</td><td>mm/s³</td><td>2</td><td>2</td><td>2</td><td>40000</td></tr> <tr><td>93</td><td>限位参数</td><td>limit_protect_force</td><td>力到限位力</td><td>N</td><td>10</td><td>10</td><td>10</td><td>40000</td></tr> <tr><td>94</td><td>限位参数</td><td>limit_protect_torque</td><td>扭矩到限位扭矩</td><td>Nm</td><td>10</td><td>10</td><td>10</td><td>40000</td></tr> <tr><td>95</td><td>限位参数</td><td>limit_protect_current</td><td>电流到限位电流</td><td>A</td><td>10</td><td>10</td><td>10</td><td>40000</td></tr> <tr><td>96</td><td>限位参数</td><td>limit_protect_voltage</td><td>电压到限位电压</td><td>V</td><td>10</td><td>10</td><td>10</td><td>40000</td></tr> <tr><td>97</td><td>限位参数</td><td>limit_protect_temperature</td><td>温度到限位温度</td><td>°C</td><td>10</td><td>10</td><td>10</td><td>40000</td></tr> <tr><td>98</td><td>限位参数</td><td>limit_protect_position</td><td>位置到限位位置</td><td>mm</td><td>10</td><td>10</td><td>10</td><td>40000</td></tr> <tr><td>99</td><td>限位参数</td><td>limit_protect_speed</td><td>速度到限位速度</td><td>mm/s</td><td>10</td><td>10</td><td>10</td><td>40000</td></tr> <tr><td>100</td><td>限位参数</td><td>limit_protect_acc</td><td>加速度到限位加速度</td><td>mm/s²</td><td>10</td><td>10</td><td>10</td><td>40000</td></tr> <tr><td>101</td><td>限位参数</td><td>limit_protect_jerk</td><td> jerk到限位jerk</td><td>mm/s³</td><td>2</td><td>2</td><td>2</td><td>40000</td></tr> <tr><td>102</td><td>限位参数</td><td>limit_protect_force</td><td>力到限位力</td><td>N</td><td>10</td><td>10</td><td>10</td><td>40000</td></tr> <tr><td>103</td><td>限位参数</td><td>limit_protect_torque</td><td>扭矩到限位扭矩</td><td>Nm</td><td>10</td><td>10</td><td>10</td><td>40000</td></tr> <tr><td>104</td><td>限位参数</td><td>limit_protect_current</td><td>电流到限位电流</td><td>A</td><td>10</td><td>10</td><td>10</td><td>40000</td></tr> <tr><td>105</td><td>限位参数</td><td>limit_protect_voltage</td><td>电压到限位电压</td><td>V</td><td>10</td><td>10</td><td>10</td><td>40000</td></tr> <tr><td>106</td><td>限位参数</td><td>limit_protect_temperature</td><td>温度到限位温度</td><td>°C</td><td>10</td><td>10</td><td>10</td><td>40000</td></tr> <tr><td>107</td><td>限位参数</td><td>limit_protect_position</td><td>位置到限位位置</td><td>mm</td><td>10</td><td>10</td><td>10</td><td>40000</td></tr> <tr><td>108</td><td>限位参数</td><td>limit_protect_speed</td><td>速度到限位速度</td><td>mm/s</td><td>10</td><td>10</td><td>10</td><td>40000</td></tr> <tr><td>109</td><td>限位参数</td><td>limit_protect_acc</td><td>加速度到限位加速度</td><td>mm/s²</td><td>10</td><td>10</td><td>10</td><td>40000</td></tr> <tr><td>110</td><td>限位参数</td><td>limit_protect_jerk</td><td> jerk到限位jerk</td><td>mm/s³</td><td>2</td><td>2</td><td>2</td><td>40000</td></tr> <tr><td>111</td><td>限位参数</td><td>limit_protect_force</td><td>力到限位力</td><td>N</td><td>10</td><td>10</td><td>10</td><td>40000</td></tr> <tr><td>112</td><td>限位参数</td><td>limit_protect_torque</td><td>扭矩到限位扭矩</td><td>Nm</td><td>10</td><td>10</td><td>10</td><td>40000</td></tr> <tr><td>113</td><td>限位参数</td><td>limit_protect_current</td><td>电流到限位电流</td><td>A</td><td>10</td><td>10</td><td>10</td><td>40000</td></tr> <tr><td>114</td><td>限位参数</td><td>limit_protect_voltage</td><td>电压到限位电压</td><td>V</td><td>10</td><td>10</td><td>10</td><td>40000</td></tr> <tr><td>115</td><td>限位参数</td><td>limit_protect_temperature</td><td>温度到限位温度</td><td>°C</td><td>10</td><td>10</td><td>10</td><td>40000</td></tr> <tr><td>116</td><td>限位参数</td><td>limit_protect_position</td><td>位置到限位位置</td><td>mm</td><td>10</td><td>10</td><td>10</td><td>40000</td></tr> <tr><td>117</td><td>限位参数</td><td>limit_protect_speed</td><td>速度到限位速度</td><td>mm/s</td><td>10</td><td>10</td><td>10</td><td>40000</td></tr> <tr><td>118</td><td>限位参数</td><td>limit_protect_acc</td><td>加速度到限位加速度</td><td>mm/s²</td><td>10</td><td>10</td><td>10</td><td>40000</td></tr> <tr><td>119</td><td>限位参数</td><td>limit_protect_jerk</td><td> jerk到限位jerk</td><td>mm/s³</td><td>2</td><td>2</td><td>2</td><td>40000</td></tr> <tr><td>120</td><td>限位参数</td><td>limit_protect_force</td><td>力到限位力</td><td>N</td><td>10</td><td>10</td><td>10</td><td>40000</td></tr> <tr><td>121</td><td>限位参数</td><td>limit_protect_torque</td><td>扭矩到限位扭矩</td><td>Nm</td><td>10</td><td>10</td><td>10</td><td>40000</td></tr> <tr><td>122</td><td>限位参数</td><td>limit_protect_current</td><td>电流到限位电流</td><td>A</td><td>10</td><td>10</td><td>10</td><td>40000</td></tr> <tr><td>123</td><td>限位参数</td><td>limit_protect_voltage</td><td>电压到限位电压</td><td>V</td><td>10</td><td>10</td><td>10</td><td>40000</td></tr> <tr><td>124</td><td>限位参数</td><td>limit_protect_temperature</td><td>温度到限位温度</td><td>°C</td><td>10</td><td>10</td><td>10</td><td>40000</td></tr> <tr><td>125</td><td>限位参数</td><td>limit_protect_position</td><td>位置到限位位置</td><td>mm</td><td>10</td><td>10</td><td>10</td><td>40000</td></tr> <tr><td>126</td><td>限位参数</td><td>limit_protect_speed</td><td>速度到限位速度</td><td>mm/s</td><td>10</td><td>10</td><td>10</td><td>40000</td></tr> <tr><td>127</td><td>限位参数</td><td>limit_protect_acc</td><td>加速度到限位加速度</td><td>mm/s²</td><td>10</td><td>10</td><td>10</td><td>40000</td></tr> <tr><td>128</td><td>限位参数</td><td>limit_protect_jerk</td><td> jerk到限位jerk</td><td>mm/s³</td><td>2</td><td>2</td><td>2</td><td>40000</td></tr> <tr><td>129</td><td>限位参数</td><td>limit_protect_force</td><td>力到限位力</td><td>N</td><td>10</td><td>10</td><td>10</td><td>40000</td></tr> <tr><td>130</td><td>限位参数</td><td>limit_protect_torque</td><td>扭矩到限位扭矩</td><td>Nm</td><td>10</td><td>10</td><td>10</td><td>40000</td></tr> <tr><td>131</td><td>限位参数</td><td>limit_protect_current</td><td>电流到限位电流</td><td>A</td><td>10</td><td>10</td><td>10</td><td>40000</td></tr> <tr><td>132</td><td>限位参数</td><td>limit_protect_voltage</td><td>电压到限位电压</td><td>V</td><td>10</td><td>10</td><td>10</td><td>40000</td></tr> <tr><td>133</td><td>限位参数</td><td>limit_protect_temperature</td><td>温度到限位温度</td><td>°C</td><td>10</td><td>10</td><td>10</td><td>40000</td></tr> <tr><td>134</td><td>限位参数</td><td>limit_protect_position</td><td>位置到限位位置</td><td>mm</td><td>10</td><td>10</td><td>10</td><td>40000</td></tr> <tr><td>135</td><td>限位参数</td><td>limit_protect_speed</td><td>速度到限位速度</td><td>mm/s</td><td>10</td><td>10</td><td>10</td><td>40000</td></tr> <tr><td>136</td><td>限位参数</td><td>limit_protect_acc</td><td>加速度到限位加速度</td><td>mm/s²</td><td>10</td><td>10</td><td>10</td><td>40000</td></tr> <tr><td>137</td><td>限位参数</td><td>limit_protect_jerk</td><td> jerk到限位jerk</td><td>mm/s³</td><td>2</td><td>2</td><td>2</td><td>40000</td></tr> <tr><td>138</td><td>限位参数</td><td>limit_protect_force</td><td>力到限位力</td><td>N</td><td>10</td><td>10</td><td>10</td><td>40000</td></tr> <tr><td>139</td><td>限位参数</td><td>limit_protect_torque</td><td>扭矩到限位扭矩</td><td>Nm</td><td>10</td><td>10</td><td>10</td><td>40000</td></tr> <tr><td>140</td><td>限位参数</td><td>limit_protect_current</td><td>电流到限位电流</td><td>A</td><td>10</td><td>10</td><td>10</td><td>40000</td></tr> <tr><td>141</td><td>限位参数</td><td>limit_protect_voltage</td><td>电压到限位电压</td><td>V</td><td>10</td><td>10</td><td>10</td><td>40000</td></tr> <tr><td>142</td><td>限位参数</td><td>limit_protect_temperature</td><td>温度到限位温度</td><td>°C</td><td>10</td><td>10</td><td>10</td><td>40000</td></tr> <tr><td>143</td><td>限位参数</td><td>limit_protect_position</td><td>位置到限位位置</td><td>mm</td><td>10</td><td>10</td><td>10</td><td>40000</td></tr> <tr><td>144</td><td>限位参数</td><td>limit_protect_speed</td><td>速度到限位速度</td><td>mm/s</td><td>10</td><td>10</td><td>10</td><td>40000</td></tr> <tr><td>145</td><td>限位参数</td><td>limit_protect_acc</td><td>加速度到限位加速度</td><td>mm/s²</td><td>10</td><td>10</td><td>10</td><td>40000</td></tr> <tr><td>146</td><td>限位参数</td><td>limit_protect_jerk</td><td> jerk到限位jerk</td><td>mm/s³</td><td>2</td><td>2</td><td>2</td><td>40000</td></tr> <tr><td>147</td><td>限位参数</td><td>limit_protect_force</td><td>力到限位力</td><td>N</td><td>10</td><td>10</td><td>10</td><td>40000</td></tr> <tr><td>148</td><td>限位参数</td><td>limit_protect_torque</td><td>扭矩到限位扭矩</td><td>Nm</td><td>10</td><td>10</td><td>10</td><td>40000</td></tr> <tr><td>149</td><td>限位参数</td><td>limit_protect_current</td><td>电流到限位电流</td><td>A</td><td>10</td><td>10</td><td>10</td><td>40000</td></tr> <tr><td>150</td><td>限位参数</td><td>limit_protect_voltage</td><td>电压到限位电压</td><td>V</td><td>10</td><td>10</td><td>10</td><td>40000</td></tr> <tr><td>151</td><td>限位参数</td><td>limit_protect_temperature</td><td>温度到限位温度</td><td>°C</td><td>10</td><td>10</td><td>10</td><td>40000</td></tr> <tr><td>152</td><td>限位参数</td><td>limit_protect_position</td><td>位置到限位位置</td><td>mm</td><td>10</td><td>10</td><td>10</td><td>40000</td></tr> <tr><td>153</td><td>限位参数</td><td>limit_protect_speed</td><td>速度到限位速度</td><td>mm/s</td><td>10</td><td>10</td><td>10</td><td>40000</td></tr> <tr><td>154</td><td>限位参数</td><td>limit_protect_acc</td><td>加速度到限位加速度</td><td>mm/s²</td><td>10</td><td>10</td><td>10</td><td>40000</td></tr> <tr><td>155</td><td>限位参数</td><td>limit_protect_jerk</td><td> jerk到限位jerk</td><td>mm/s³</td><td>2</td><td>2</td><td>2</td><td>40000</td></tr> <tr><td>156</td><td>限位参数</td><td>limit_protect_force</td><td>力到限位力</td><td>N</td><td>10</td><td>10</td><td>10</td><td>40000</td></tr> <tr><td>157</td><td>限位参数</td><td>limit_protect_torque</td><td>扭矩到限位扭矩</td><td>Nm</td><td>10</td><td>10</td><td>10</td><td>40000</td></tr> <tr><td>158</td><td>限位参数</td><td>limit_protect_current</td><td>电流到限位电流</td><td>A</td><td>10</td><td>10</td><td>10</td><td>40000</td></tr> <tr><td>159</td><td>限位参数</td><td>limit_protect_voltage</td><td>电压到限位电压</td><td>V</td><td>10</td><td>10</td><td>10</td><td>40000</td></tr> <tr><td>160</td><td>限位参数</td><td>limit_protect_temperature</td><td>温度到限位温度</td><td>°C</td><td>10</td><td>10</td><td>10</td><td>40000</td></tr> <tr><td>161</td><td>限位参数</td><td>limit_protect_position</td><td>位置到限位位置</td><td>mm</td><td>10</td><td>10</td><td>10</td><td>40000</td></tr> <tr><td>162</td><td>限位参数</td><td>limit_protect_speed</td><td>速度到限位速度</td><td>mm/s</td><td>10</td><td>10</td><td>10</td><td>40000</td></tr> <tr><td>163</td><td>限位参数</td><td>limit_protect_acc</td><td>加速度到限位加速度</td><td>mm/s²</td><td>10</td><td>10</td><td>10</td><td>40000</td></tr> <tr><td>164</td><td>限位参数</td><td>limit_protect_jerk</td><td> jerk到限位jerk</td><td>mm/s³</td><td>2</td><td>2</td><td>2</td><td>40000</td></tr> <tr><td>165</td><td>限位参数</td><td>limit_protect_force</td><td>力到限位力</td><td>N</td><td>10</td><td>10</td><td>10</td><td>40000</td></tr> <tr><td>166</td><td>限位参数</td><td>limit_protect_torque</td><td>扭矩到限位扭矩</td><td>Nm</td><td>10</td><td>10</td><td>10</td><td>40000</td></tr> <tr><td>167</td><td>限位参数</td><td>limit_protect_current</td><td>电流到限位电流</td><td>A</td><td>10</td><td>10</td><td>10</td><td>40000</td></tr> <tr><td>168</td><td>限位参数</td><td>limit_protect_voltage</td><td>电压到限位电压</td><td>V</td><td>10</td><td>10</td><td>10</td><td>40000</td></tr> <tr><td>169</td><td>限位参数</td><td>limit_protect_temperature</td><td>温度到限位温度</td><td>°C</td><td>10</td><td>10</td><td>10</td><td>40000</td></tr> <tr><td>170</td><td>限位参数</td><td>limit_protect_position</td><td>位置到限位位置</td><td>mm</td><td>10</td><td>10</td><td>10</td><td>40000</td></tr> <tr><td>171</td><td>限位参数</td><td>limit_protect_speed</td><td>速度到限位速度</td><td>mm/s</td><td>10</td><td>10</td><td>10</td><td>40000</td></tr> <tr><td>172</td><td>限位参数</td><td>limit_protect_acc</td><td>加速度到限位加速度</td><td>mm/s²</td><td>10</td><td>10</td><td>10</td><td>40000</td></tr> <tr><td>173</td><td>限位参数</td><td>limit_protect_jerk</td><td> jerk到限位jerk</td><td>mm/s³</td><td>2</td><td>2</td><td>2</td><td>40000</td></tr> <tr><td>174</td><td>限位参数</td><td>limit_protect_force</td><td>力到限位力</td><td>N</td><td>10</td><td>10</td><td>10</td><td>40000</td></tr> <tr><td>175</td><td>限位参数</td><td>limit_protect_torque</td><td>扭矩到限位扭矩</td><td>Nm</td><td>10</td><td>10</td><td>10</td><td>40000</td></tr> <tr><td>176</td><td>限位参数</td><td>limit_protect_current</td><td>电流到限位电流</td><td>A</td><td>10</td><td>10</td><td>10</td><td>40000</td></tr> <tr><td>177</td><td>限位参数</td><td>limit_protect_voltage</td><td>电压到限位电压</td><td>V</td><td>10</td><td>10</td><td>10</td><td>40000</td></tr> <tr><td>178</td><td>限位参数</td><td>limit_protect_temperature</td><td>温度到限位温度</td><td>°C</td><td>10</td><td>10</td><td>10</td><td>40000</td></tr> <tr><td>179</td><td>限位参数</td><td>limit_protect_position</td><td>位置到限位位置</td><td>mm</td><td>10</td><td>10</td><td>10</td><td>40000</td></tr> <tr><td>180</td><td>限位参数</td><td>limit_protect_speed</td><td>速度到限位速度</td><td>mm/s</td><td>10</td><td>10</td><td>10</td><td>40000</td></tr> <tr><td>181</td><td>限位参数</td><td>limit_protect_acc</td><td>加速度到限位加速度</td><td>mm/s²</td><td>10</td><td>10</td><td>10</td><td>40000</td></tr> <tr><td>182</td><td>限位参数</td><td>limit_protect_jerk</td><td> jerk到限位jerk</td><td>mm/s³</td><td>2</td><td>2</td><td>2</td><td>40000</td></tr> <tr><td>183</td><td>限位参数</td><td>limit_protect_force</td><td>力到限位力</td><td>N</td><td>10</td><td>10</td><td>10</td><td>40000</td></tr> <tr><td>184</td><td>限位参数</td><td>limit_protect_torque</td><td>扭矩到限位扭矩</td><td>Nm</td><td>10</td><td>10</td><td>10</td><td>40000</td></tr> <tr><td>185</td><td>限位参数</td><td>limit_protect_current</td><td>电流到限位电流</td><td>A</td><td>10</td><td>10</td><td>10</td><td>40000</td></tr> <tr><td>186</td><td>限位参数</td><td>limit_protect_voltage</td><td>电压到限位电压</td><td>V</td><td>10</td><td>10</td><td>10</td><td>40000</td></tr> <tr><td>187</td><td>限位参数</td><td>limit_protect_temperature</td><td>温度到限位温度</td><td>°C</td><td>10</td><td>10</td><td>10</td><td>40000</td></tr> <tr><td>188</td><td>限位参数</td><td>limit_protect_position</td><td>位置到限位位置</td><td>mm</td><td>10</td><td>10</td><td>10</td><td>40000</td></tr> <tr><td>189</td><td>限位参数</td><td>limit_protect_speed</td><td>速度到限位速度</td><td>mm/s</td><td>10</td><td>10</td><td>10</td><td>40000</td></tr> <tr><td>190</td><td>限位参数</td><td>limit_protect_acc</td><td>加速度到限位加速度</td><td>mm/s²</td><td>10</td><td>10</td><td>10</td><td>40000</td></tr> <tr><td>191</td><td>限位参数</td><td>limit_protect_jerk</td><td> jerk到限位jerk</td><td>mm/s³</td><td>2</td><td>2</td><td>2</td><td>40000</td></tr> <tr><td>192</td><td>限位参数</td><td>limit_protect_force</td><td>力到限位力</td><td>N</td><td>10</td><td>10</td><td>10</td><td>40000</td></tr> <tr><td>193</td><td>限位参数</td><td>limit_protect_torque</td><td>扭矩到限位扭矩</td><td>Nm</td><td>10</td><td>10</td><td>10</td><td>40000</td></tr> <tr><td>194</td><td>限位参数</td><td>limit_protect_current</td><td>电流到限位电流</td><td>A</td><td>10</td><td>10</td><td>10</td><td>40000</td></tr> <tr><td>195</td><td>限位参数</td><td>limit_protect_voltage</td><td>电压到限位电压</td><td>V</td><td>10</td><td>10</td><td>10</td><td>40000</td></tr> <tr><td>196</td><td>限位参数</td><td>limit_protect_temperature</td><td>温度到限位温度</td><td>°C</td><td>10</td><td>10</td><td>10</td><td>40000</td></tr> <tr><td>197</td><td>限位参数</td><td>limit_protect_position</td><td>位置到限位位置</td><td>mm</td><td>10</td><td>10</td><td>10</td><td>40000</td></tr> <tr><td>198</td><td>限位参数</td><td>limit_protect_speed</td><td>速度到限位速度</td><td>mm/s</td><td>10</td><td>10</td><td>10</td><td>40000</td></tr> <tr><td>199</td><td>限位参数</td><td>limit_protect_acc</td><td>加速度到限位加速度</td><td>mm/s²</td><td>10</td><td>10</td><td>10</td><td>40000</td></tr> <tr><td>200</td><td>限位参数</td><td>limit_protect_jerk</td><td> jerk到限位jerk</td><td>mm/s³</td><td>2</td><td>2</td><td>2</td><td>40000</td></tr> </tbody> </table>	参数号	描述名称	参数名	单位	范围	出厂值	最小值	最大值	备注	61	限位参数	limit_protect_enable	逻辑	0-1	0	0	1	使能硬限位	62	限位参数	limit_protect_time	位置到限位时间	ms	10	10	10	40000	63	限位参数	limit_protect_speed	速度到限位速度	mm	10	10	10	40000	64	限位参数	limit_protect_acc	加速度到限位加速度	mm/s²	10	10	10	40000	65	限位参数	limit_protect_jerk	jerk到限位jerk	mm/s³	2	2	2	40000	66	限位参数	limit_protect_force	力到限位力	N	10	10	10	40000	67	限位参数	limit_protect_torque	扭矩到限位扭矩	Nm	10	10	10	40000	68	限位参数	limit_protect_current	电流到限位电流	A	10	10	10	40000	69	限位参数	limit_protect_voltage	电压到限位电压	V	10	10	10	40000	70	限位参数	limit_protect_temperature	温度到限位温度	°C	10	10	10	40000	71	限位参数	limit_protect_position	位置到限位位置	mm	10	10	10	40000	72	限位参数	limit_protect_speed	速度到限位速度	mm/s	10	10	10	40000	73	限位参数	limit_protect_acc	加速度到限位加速度	mm/s²	10	10	10	40000	74	限位参数	limit_protect_jerk	jerk到限位jerk	mm/s³	2	2	2	40000	75	限位参数	limit_protect_force	力到限位力	N	10	10	10	40000	76	限位参数	limit_protect_torque	扭矩到限位扭矩	Nm	10	10	10	40000	77	限位参数	limit_protect_current	电流到限位电流	A	10	10	10	40000	78	限位参数	limit_protect_voltage	电压到限位电压	V	10	10	10	40000	79	限位参数	limit_protect_temperature	温度到限位温度	°C	10	10	10	40000	80	限位参数	limit_protect_position	位置到限位位置	mm	10	10	10	40000	81	限位参数	limit_protect_speed	速度到限位速度	mm/s	10	10	10	40000	82	限位参数	limit_protect_acc	加速度到限位加速度	mm/s²	10	10	10	40000	83	限位参数	limit_protect_jerk	jerk到限位jerk	mm/s³	2	2	2	40000	84	限位参数	limit_protect_force	力到限位力	N	10	10	10	40000	85	限位参数	limit_protect_torque	扭矩到限位扭矩	Nm	10	10	10	40000	86	限位参数	limit_protect_current	电流到限位电流	A	10	10	10	40000	87	限位参数	limit_protect_voltage	电压到限位电压	V	10	10	10	40000	88	限位参数	limit_protect_temperature	温度到限位温度	°C	10	10	10	40000	89	限位参数	limit_protect_position	位置到限位位置	mm	10	10	10	40000	90	限位参数	limit_protect_speed	速度到限位速度	mm/s	10	10	10	40000	91	限位参数	limit_protect_acc	加速度到限位加速度	mm/s²	10	10	10	40000	92	限位参数	limit_protect_jerk	jerk到限位jerk	mm/s³	2	2	2	40000	93	限位参数	limit_protect_force	力到限位力	N	10	10	10	40000	94	限位参数	limit_protect_torque	扭矩到限位扭矩	Nm	10	10	10	40000	95	限位参数	limit_protect_current	电流到限位电流	A	10	10	10	40000	96	限位参数	limit_protect_voltage	电压到限位电压	V	10	10	10	40000	97	限位参数	limit_protect_temperature	温度到限位温度	°C	10	10	10	40000	98	限位参数	limit_protect_position	位置到限位位置	mm	10	10	10	40000	99	限位参数	limit_protect_speed	速度到限位速度	mm/s	10	10	10	40000	100	限位参数	limit_protect_acc	加速度到限位加速度	mm/s²	10	10	10	40000	101	限位参数	limit_protect_jerk	jerk到限位jerk	mm/s³	2	2	2	40000	102	限位参数	limit_protect_force	力到限位力	N	10	10	10	40000	103	限位参数	limit_protect_torque	扭矩到限位扭矩	Nm	10	10	10	40000	104	限位参数	limit_protect_current	电流到限位电流	A	10	10	10	40000	105	限位参数	limit_protect_voltage	电压到限位电压	V	10	10	10	40000	106	限位参数	limit_protect_temperature	温度到限位温度	°C	10	10	10	40000	107	限位参数	limit_protect_position	位置到限位位置	mm	10	10	10	40000	108	限位参数	limit_protect_speed	速度到限位速度	mm/s	10	10	10	40000	109	限位参数	limit_protect_acc	加速度到限位加速度	mm/s²	10	10	10	40000	110	限位参数	limit_protect_jerk	jerk到限位jerk	mm/s³	2	2	2	40000	111	限位参数	limit_protect_force	力到限位力	N	10	10	10	40000	112	限位参数	limit_protect_torque	扭矩到限位扭矩	Nm	10	10	10	40000	113	限位参数	limit_protect_current	电流到限位电流	A	10	10	10	40000	114	限位参数	limit_protect_voltage	电压到限位电压	V	10	10	10	40000	115	限位参数	limit_protect_temperature	温度到限位温度	°C	10	10	10	40000	116	限位参数	limit_protect_position	位置到限位位置	mm	10	10	10	40000	117	限位参数	limit_protect_speed	速度到限位速度	mm/s	10	10	10	40000	118	限位参数	limit_protect_acc	加速度到限位加速度	mm/s²	10	10	10	40000	119	限位参数	limit_protect_jerk	jerk到限位jerk	mm/s³	2	2	2	40000	120	限位参数	limit_protect_force	力到限位力	N	10	10	10	40000	121	限位参数	limit_protect_torque	扭矩到限位扭矩	Nm	10	10	10	40000	122	限位参数	limit_protect_current	电流到限位电流	A	10	10	10	40000	123	限位参数	limit_protect_voltage	电压到限位电压	V	10	10	10	40000	124	限位参数	limit_protect_temperature	温度到限位温度	°C	10	10	10	40000	125	限位参数	limit_protect_position	位置到限位位置	mm	10	10	10	40000	126	限位参数	limit_protect_speed	速度到限位速度	mm/s	10	10	10	40000	127	限位参数	limit_protect_acc	加速度到限位加速度	mm/s²	10	10	10	40000	128	限位参数	limit_protect_jerk	jerk到限位jerk	mm/s³	2	2	2	40000	129	限位参数	limit_protect_force	力到限位力	N	10	10	10	40000	130	限位参数	limit_protect_torque	扭矩到限位扭矩	Nm	10	10	10	40000	131	限位参数	limit_protect_current	电流到限位电流	A	10	10	10	40000	132	限位参数	limit_protect_voltage	电压到限位电压	V	10	10	10	40000	133	限位参数	limit_protect_temperature	温度到限位温度	°C	10	10	10	40000	134	限位参数	limit_protect_position	位置到限位位置	mm	10	10	10	40000	135	限位参数	limit_protect_speed	速度到限位速度	mm/s	10	10	10	40000	136	限位参数	limit_protect_acc	加速度到限位加速度	mm/s²	10	10	10	40000	137	限位参数	limit_protect_jerk	jerk到限位jerk	mm/s³	2	2	2	40000	138	限位参数	limit_protect_force	力到限位力	N	10	10	10	40000	139	限位参数	limit_protect_torque	扭矩到限位扭矩	Nm	10	10	10	40000	140	限位参数	limit_protect_current	电流到限位电流	A	10	10	10	40000	141	限位参数	limit_protect_voltage	电压到限位电压	V	10	10	10	40000	142	限位参数	limit_protect_temperature	温度到限位温度	°C	10	10	10	40000	143	限位参数	limit_protect_position	位置到限位位置	mm	10	10	10	40000	144	限位参数	limit_protect_speed	速度到限位速度	mm/s	10	10	10	40000	145	限位参数	limit_protect_acc	加速度到限位加速度	mm/s²	10	10	10	40000	146	限位参数	limit_protect_jerk	jerk到限位jerk	mm/s³	2	2	2	40000	147	限位参数	limit_protect_force	力到限位力	N	10	10	10	40000	148	限位参数	limit_protect_torque	扭矩到限位扭矩	Nm	10	10	10	40000	149	限位参数	limit_protect_current	电流到限位电流	A	10	10	10	40000	150	限位参数	limit_protect_voltage	电压到限位电压	V	10	10	10	40000	151	限位参数	limit_protect_temperature	温度到限位温度	°C	10	10	10	40000	152	限位参数	limit_protect_position	位置到限位位置	mm	10	10	10	40000	153	限位参数	limit_protect_speed	速度到限位速度	mm/s	10	10	10	40000	154	限位参数	limit_protect_acc	加速度到限位加速度	mm/s²	10	10	10	40000	155	限位参数	limit_protect_jerk	jerk到限位jerk	mm/s³	2	2	2	40000	156	限位参数	limit_protect_force	力到限位力	N	10	10	10	40000	157	限位参数	limit_protect_torque	扭矩到限位扭矩	Nm	10	10	10	40000	158	限位参数	limit_protect_current	电流到限位电流	A	10	10	10	40000	159	限位参数	limit_protect_voltage	电压到限位电压	V	10	10	10	40000	160	限位参数	limit_protect_temperature	温度到限位温度	°C	10	10	10	40000	161	限位参数	limit_protect_position	位置到限位位置	mm	10	10	10	40000	162	限位参数	limit_protect_speed	速度到限位速度	mm/s	10	10	10	40000	163	限位参数	limit_protect_acc	加速度到限位加速度	mm/s²	10	10	10	40000	164	限位参数	limit_protect_jerk	jerk到限位jerk	mm/s³	2	2	2	40000	165	限位参数	limit_protect_force	力到限位力	N	10	10	10	40000	166	限位参数	limit_protect_torque	扭矩到限位扭矩	Nm	10	10	10	40000	167	限位参数	limit_protect_current	电流到限位电流	A	10	10	10	40000	168	限位参数	limit_protect_voltage	电压到限位电压	V	10	10	10	40000	169	限位参数	limit_protect_temperature	温度到限位温度	°C	10	10	10	40000	170	限位参数	limit_protect_position	位置到限位位置	mm	10	10	10	40000	171	限位参数	limit_protect_speed	速度到限位速度	mm/s	10	10	10	40000	172	限位参数	limit_protect_acc	加速度到限位加速度	mm/s²	10	10	10	40000	173	限位参数	limit_protect_jerk	jerk到限位jerk	mm/s³	2	2	2	40000	174	限位参数	limit_protect_force	力到限位力	N	10	10	10	40000	175	限位参数	limit_protect_torque	扭矩到限位扭矩	Nm	10	10	10	40000	176	限位参数	limit_protect_current	电流到限位电流	A	10	10	10	40000	177	限位参数	limit_protect_voltage	电压到限位电压	V	10	10	10	40000	178	限位参数	limit_protect_temperature	温度到限位温度	°C	10	10	10	40000	179	限位参数	limit_protect_position	位置到限位位置	mm	10	10	10	40000	180	限位参数	limit_protect_speed	速度到限位速度	mm/s	10	10	10	40000	181	限位参数	limit_protect_acc	加速度到限位加速度	mm/s²	10	10	10	40000	182	限位参数	limit_protect_jerk	jerk到限位jerk	mm/s³	2	2	2	40000	183	限位参数	limit_protect_force	力到限位力	N	10	10	10	40000	184	限位参数	limit_protect_torque	扭矩到限位扭矩	Nm	10	10	10	40000	185	限位参数	limit_protect_current	电流到限位电流	A	10	10	10	40000	186	限位参数	limit_protect_voltage	电压到限位电压	V	10	10	10	40000	187	限位参数	limit_protect_temperature	温度到限位温度	°C	10	10	10	40000	188	限位参数	limit_protect_position	位置到限位位置	mm	10	10	10	40000	189	限位参数	limit_protect_speed	速度到限位速度	mm/s	10	10	10	40000	190	限位参数	limit_protect_acc	加速度到限位加速度	mm/s²	10	10	10	40000	191	限位参数	limit_protect_jerk	jerk到限位jerk	mm/s³	2	2	2	40000	192	限位参数	limit_protect_force	力到限位力	N	10	10	10	40000	193	限位参数	limit_protect_torque	扭矩到限位扭矩	Nm	10	10	10	40000	194	限位参数	limit_protect_current	电流到限位电流	A	10	10	10	40000	195	限位参数	limit_protect_voltage	电压到限位电压	V	10	10	10	40000	196	限位参数	limit_protect_temperature	温度到限位温度	°C	10	10	10	40000	197	限位参数	limit_protect_position	位置到限位位置	mm	10	10	10	40000	198	限位参数	limit_protect_speed	速度到限位速度	mm/s	10	10	10	40000	199	限位参数	limit_protect_acc	加速度到限位加速度	mm/s²	10	10	10	40000	200	限位参数	limit_protect_jerk	jerk到限位jerk	mm/s³	2	2	2	40000
参数号	描述名称	参数名	单位	范围	出厂值	最小值	最大值	备注																																																																																																																																																																																																																																																																																																																																																																																																																																																																																																																																																																																																																																																																																																																																																																																																																																																																																																																																																																																																																																																																																																																																																																																																																																																																																																														
61	限位参数	limit_protect_enable	逻辑	0-1	0	0	1	使能硬限位																																																																																																																																																																																																																																																																																																																																																																																																																																																																																																																																																																																																																																																																																																																																																																																																																																																																																																																																																																																																																																																																																																																																																																																																																																																																																																														
62	限位参数	limit_protect_time	位置到限位时间	ms	10	10	10	40000																																																																																																																																																																																																																																																																																																																																																																																																																																																																																																																																																																																																																																																																																																																																																																																																																																																																																																																																																																																																																																																																																																																																																																																																																																																																																																														
63	限位参数	limit_protect_speed	速度到限位速度	mm	10	10	10	40000																																																																																																																																																																																																																																																																																																																																																																																																																																																																																																																																																																																																																																																																																																																																																																																																																																																																																																																																																																																																																																																																																																																																																																																																																																																																																																														
64	限位参数	limit_protect_acc	加速度到限位加速度	mm/s²	10	10	10	40000																																																																																																																																																																																																																																																																																																																																																																																																																																																																																																																																																																																																																																																																																																																																																																																																																																																																																																																																																																																																																																																																																																																																																																																																																																																																																																														
65	限位参数	limit_protect_jerk	jerk到限位jerk	mm/s³	2	2	2	40000																																																																																																																																																																																																																																																																																																																																																																																																																																																																																																																																																																																																																																																																																																																																																																																																																																																																																																																																																																																																																																																																																																																																																																																																																																																																																																														
66	限位参数	limit_protect_force	力到限位力	N	10	10	10	40000																																																																																																																																																																																																																																																																																																																																																																																																																																																																																																																																																																																																																																																																																																																																																																																																																																																																																																																																																																																																																																																																																																																																																																																																																																																																																																														
67	限位参数	limit_protect_torque	扭矩到限位扭矩	Nm	10	10	10	40000																																																																																																																																																																																																																																																																																																																																																																																																																																																																																																																																																																																																																																																																																																																																																																																																																																																																																																																																																																																																																																																																																																																																																																																																																																																																																																														
68	限位参数	limit_protect_current	电流到限位电流	A	10	10	10	40000																																																																																																																																																																																																																																																																																																																																																																																																																																																																																																																																																																																																																																																																																																																																																																																																																																																																																																																																																																																																																																																																																																																																																																																																																																																																																																														
69	限位参数	limit_protect_voltage	电压到限位电压	V	10	10	10	40000																																																																																																																																																																																																																																																																																																																																																																																																																																																																																																																																																																																																																																																																																																																																																																																																																																																																																																																																																																																																																																																																																																																																																																																																																																																																																																														
70	限位参数	limit_protect_temperature	温度到限位温度	°C	10	10	10	40000																																																																																																																																																																																																																																																																																																																																																																																																																																																																																																																																																																																																																																																																																																																																																																																																																																																																																																																																																																																																																																																																																																																																																																																																																																																																																																														
71	限位参数	limit_protect_position	位置到限位位置	mm	10	10	10	40000																																																																																																																																																																																																																																																																																																																																																																																																																																																																																																																																																																																																																																																																																																																																																																																																																																																																																																																																																																																																																																																																																																																																																																																																																																																																																																														
72	限位参数	limit_protect_speed	速度到限位速度	mm/s	10	10	10	40000																																																																																																																																																																																																																																																																																																																																																																																																																																																																																																																																																																																																																																																																																																																																																																																																																																																																																																																																																																																																																																																																																																																																																																																																																																																																																																														
73	限位参数	limit_protect_acc	加速度到限位加速度	mm/s²	10	10	10	40000																																																																																																																																																																																																																																																																																																																																																																																																																																																																																																																																																																																																																																																																																																																																																																																																																																																																																																																																																																																																																																																																																																																																																																																																																																																																																																														
74	限位参数	limit_protect_jerk	jerk到限位jerk	mm/s³	2	2	2	40000																																																																																																																																																																																																																																																																																																																																																																																																																																																																																																																																																																																																																																																																																																																																																																																																																																																																																																																																																																																																																																																																																																																																																																																																																																																																																																														
75	限位参数	limit_protect_force	力到限位力	N	10	10	10	40000																																																																																																																																																																																																																																																																																																																																																																																																																																																																																																																																																																																																																																																																																																																																																																																																																																																																																																																																																																																																																																																																																																																																																																																																																																																																																																														
76	限位参数	limit_protect_torque	扭矩到限位扭矩	Nm	10	10	10	40000																																																																																																																																																																																																																																																																																																																																																																																																																																																																																																																																																																																																																																																																																																																																																																																																																																																																																																																																																																																																																																																																																																																																																																																																																																																																																																														
77	限位参数	limit_protect_current	电流到限位电流	A	10	10	10	40000																																																																																																																																																																																																																																																																																																																																																																																																																																																																																																																																																																																																																																																																																																																																																																																																																																																																																																																																																																																																																																																																																																																																																																																																																																																																																																														
78	限位参数	limit_protect_voltage	电压到限位电压	V	10	10	10	40000																																																																																																																																																																																																																																																																																																																																																																																																																																																																																																																																																																																																																																																																																																																																																																																																																																																																																																																																																																																																																																																																																																																																																																																																																																																																																																														
79	限位参数	limit_protect_temperature	温度到限位温度	°C	10	10	10	40000																																																																																																																																																																																																																																																																																																																																																																																																																																																																																																																																																																																																																																																																																																																																																																																																																																																																																																																																																																																																																																																																																																																																																																																																																																																																																																														
80	限位参数	limit_protect_position	位置到限位位置	mm	10	10	10	40000																																																																																																																																																																																																																																																																																																																																																																																																																																																																																																																																																																																																																																																																																																																																																																																																																																																																																																																																																																																																																																																																																																																																																																																																																																																																																																														
81	限位参数	limit_protect_speed	速度到限位速度	mm/s	10	10	10	40000																																																																																																																																																																																																																																																																																																																																																																																																																																																																																																																																																																																																																																																																																																																																																																																																																																																																																																																																																																																																																																																																																																																																																																																																																																																																																																														
82	限位参数	limit_protect_acc	加速度到限位加速度	mm/s²	10	10	10	40000																																																																																																																																																																																																																																																																																																																																																																																																																																																																																																																																																																																																																																																																																																																																																																																																																																																																																																																																																																																																																																																																																																																																																																																																																																																																																																														
83	限位参数	limit_protect_jerk	jerk到限位jerk	mm/s³	2	2	2	40000																																																																																																																																																																																																																																																																																																																																																																																																																																																																																																																																																																																																																																																																																																																																																																																																																																																																																																																																																																																																																																																																																																																																																																																																																																																																																																														
84	限位参数	limit_protect_force	力到限位力	N	10	10	10	40000																																																																																																																																																																																																																																																																																																																																																																																																																																																																																																																																																																																																																																																																																																																																																																																																																																																																																																																																																																																																																																																																																																																																																																																																																																																																																																														
85	限位参数	limit_protect_torque	扭矩到限位扭矩	Nm	10	10	10	40000																																																																																																																																																																																																																																																																																																																																																																																																																																																																																																																																																																																																																																																																																																																																																																																																																																																																																																																																																																																																																																																																																																																																																																																																																																																																																																														
86	限位参数	limit_protect_current	电流到限位电流	A	10	10	10	40000																																																																																																																																																																																																																																																																																																																																																																																																																																																																																																																																																																																																																																																																																																																																																																																																																																																																																																																																																																																																																																																																																																																																																																																																																																																																																																														
87	限位参数	limit_protect_voltage	电压到限位电压	V	10	10	10	40000																																																																																																																																																																																																																																																																																																																																																																																																																																																																																																																																																																																																																																																																																																																																																																																																																																																																																																																																																																																																																																																																																																																																																																																																																																																																																																														
88	限位参数	limit_protect_temperature	温度到限位温度	°C	10	10	10	40000																																																																																																																																																																																																																																																																																																																																																																																																																																																																																																																																																																																																																																																																																																																																																																																																																																																																																																																																																																																																																																																																																																																																																																																																																																																																																																														
89	限位参数	limit_protect_position	位置到限位位置	mm	10	10	10	40000																																																																																																																																																																																																																																																																																																																																																																																																																																																																																																																																																																																																																																																																																																																																																																																																																																																																																																																																																																																																																																																																																																																																																																																																																																																																																																														
90	限位参数	limit_protect_speed	速度到限位速度	mm/s	10	10	10	40000																																																																																																																																																																																																																																																																																																																																																																																																																																																																																																																																																																																																																																																																																																																																																																																																																																																																																																																																																																																																																																																																																																																																																																																																																																																																																																														
91	限位参数	limit_protect_acc	加速度到限位加速度	mm/s²	10	10	10	40000																																																																																																																																																																																																																																																																																																																																																																																																																																																																																																																																																																																																																																																																																																																																																																																																																																																																																																																																																																																																																																																																																																																																																																																																																																																																																																														
92	限位参数	limit_protect_jerk	jerk到限位jerk	mm/s³	2	2	2	40000																																																																																																																																																																																																																																																																																																																																																																																																																																																																																																																																																																																																																																																																																																																																																																																																																																																																																																																																																																																																																																																																																																																																																																																																																																																																																																														
93	限位参数	limit_protect_force	力到限位力	N	10	10	10	40000																																																																																																																																																																																																																																																																																																																																																																																																																																																																																																																																																																																																																																																																																																																																																																																																																																																																																																																																																																																																																																																																																																																																																																																																																																																																																																														
94	限位参数	limit_protect_torque	扭矩到限位扭矩	Nm	10	10	10	40000																																																																																																																																																																																																																																																																																																																																																																																																																																																																																																																																																																																																																																																																																																																																																																																																																																																																																																																																																																																																																																																																																																																																																																																																																																																																																																														
95	限位参数	limit_protect_current	电流到限位电流	A	10	10	10	40000																																																																																																																																																																																																																																																																																																																																																																																																																																																																																																																																																																																																																																																																																																																																																																																																																																																																																																																																																																																																																																																																																																																																																																																																																																																																																																														
96	限位参数	limit_protect_voltage	电压到限位电压	V	10	10	10	40000																																																																																																																																																																																																																																																																																																																																																																																																																																																																																																																																																																																																																																																																																																																																																																																																																																																																																																																																																																																																																																																																																																																																																																																																																																																																																																														
97	限位参数	limit_protect_temperature	温度到限位温度	°C	10	10	10	40000																																																																																																																																																																																																																																																																																																																																																																																																																																																																																																																																																																																																																																																																																																																																																																																																																																																																																																																																																																																																																																																																																																																																																																																																																																																																																																														
98	限位参数	limit_protect_position	位置到限位位置	mm	10	10	10	40000																																																																																																																																																																																																																																																																																																																																																																																																																																																																																																																																																																																																																																																																																																																																																																																																																																																																																																																																																																																																																																																																																																																																																																																																																																																																																																														
99	限位参数	limit_protect_speed	速度到限位速度	mm/s	10	10	10	40000																																																																																																																																																																																																																																																																																																																																																																																																																																																																																																																																																																																																																																																																																																																																																																																																																																																																																																																																																																																																																																																																																																																																																																																																																																																																																																														
100	限位参数	limit_protect_acc	加速度到限位加速度	mm/s²	10	10	10	40000																																																																																																																																																																																																																																																																																																																																																																																																																																																																																																																																																																																																																																																																																																																																																																																																																																																																																																																																																																																																																																																																																																																																																																																																																																																																																																														
101	限位参数	limit_protect_jerk	jerk到限位jerk	mm/s³	2	2	2	40000																																																																																																																																																																																																																																																																																																																																																																																																																																																																																																																																																																																																																																																																																																																																																																																																																																																																																																																																																																																																																																																																																																																																																																																																																																																																																																														
102	限位参数	limit_protect_force	力到限位力	N	10	10	10	40000																																																																																																																																																																																																																																																																																																																																																																																																																																																																																																																																																																																																																																																																																																																																																																																																																																																																																																																																																																																																																																																																																																																																																																																																																																																																																																														
103	限位参数	limit_protect_torque	扭矩到限位扭矩	Nm	10	10	10	40000																																																																																																																																																																																																																																																																																																																																																																																																																																																																																																																																																																																																																																																																																																																																																																																																																																																																																																																																																																																																																																																																																																																																																																																																																																																																																																														
104	限位参数	limit_protect_current	电流到限位电流	A	10	10	10	40000																																																																																																																																																																																																																																																																																																																																																																																																																																																																																																																																																																																																																																																																																																																																																																																																																																																																																																																																																																																																																																																																																																																																																																																																																																																																																																														
105	限位参数	limit_protect_voltage	电压到限位电压	V	10	10	10	40000																																																																																																																																																																																																																																																																																																																																																																																																																																																																																																																																																																																																																																																																																																																																																																																																																																																																																																																																																																																																																																																																																																																																																																																																																																																																																																														
106	限位参数	limit_protect_temperature	温度到限位温度	°C	10	10	10	40000																																																																																																																																																																																																																																																																																																																																																																																																																																																																																																																																																																																																																																																																																																																																																																																																																																																																																																																																																																																																																																																																																																																																																																																																																																																																																																														
107	限位参数	limit_protect_position	位置到限位位置	mm	10	10	10	40000																																																																																																																																																																																																																																																																																																																																																																																																																																																																																																																																																																																																																																																																																																																																																																																																																																																																																																																																																																																																																																																																																																																																																																																																																																																																																																														
108	限位参数	limit_protect_speed	速度到限位速度	mm/s	10	10	10	40000																																																																																																																																																																																																																																																																																																																																																																																																																																																																																																																																																																																																																																																																																																																																																																																																																																																																																																																																																																																																																																																																																																																																																																																																																																																																																																														
109	限位参数	limit_protect_acc	加速度到限位加速度	mm/s²	10	10	10	40000																																																																																																																																																																																																																																																																																																																																																																																																																																																																																																																																																																																																																																																																																																																																																																																																																																																																																																																																																																																																																																																																																																																																																																																																																																																																																																														
110	限位参数	limit_protect_jerk	jerk到限位jerk	mm/s³	2	2	2	40000																																																																																																																																																																																																																																																																																																																																																																																																																																																																																																																																																																																																																																																																																																																																																																																																																																																																																																																																																																																																																																																																																																																																																																																																																																																																																																														
111	限位参数	limit_protect_force	力到限位力	N	10	10	10	40000																																																																																																																																																																																																																																																																																																																																																																																																																																																																																																																																																																																																																																																																																																																																																																																																																																																																																																																																																																																																																																																																																																																																																																																																																																																																																																														
112	限位参数	limit_protect_torque	扭矩到限位扭矩	Nm	10	10	10	40000																																																																																																																																																																																																																																																																																																																																																																																																																																																																																																																																																																																																																																																																																																																																																																																																																																																																																																																																																																																																																																																																																																																																																																																																																																																																																																														
113	限位参数	limit_protect_current	电流到限位电流	A	10	10	10	40000																																																																																																																																																																																																																																																																																																																																																																																																																																																																																																																																																																																																																																																																																																																																																																																																																																																																																																																																																																																																																																																																																																																																																																																																																																																																																																														
114	限位参数	limit_protect_voltage	电压到限位电压	V	10	10	10	40000																																																																																																																																																																																																																																																																																																																																																																																																																																																																																																																																																																																																																																																																																																																																																																																																																																																																																																																																																																																																																																																																																																																																																																																																																																																																																																														
115	限位参数	limit_protect_temperature	温度到限位温度	°C	10	10	10	40000																																																																																																																																																																																																																																																																																																																																																																																																																																																																																																																																																																																																																																																																																																																																																																																																																																																																																																																																																																																																																																																																																																																																																																																																																																																																																																														
116	限位参数	limit_protect_position	位置到限位位置	mm	10	10	10	40000																																																																																																																																																																																																																																																																																																																																																																																																																																																																																																																																																																																																																																																																																																																																																																																																																																																																																																																																																																																																																																																																																																																																																																																																																																																																																																														
117	限位参数	limit_protect_speed	速度到限位速度	mm/s	10	10	10	40000																																																																																																																																																																																																																																																																																																																																																																																																																																																																																																																																																																																																																																																																																																																																																																																																																																																																																																																																																																																																																																																																																																																																																																																																																																																																																																														
118	限位参数	limit_protect_acc	加速度到限位加速度	mm/s²	10	10	10	40000																																																																																																																																																																																																																																																																																																																																																																																																																																																																																																																																																																																																																																																																																																																																																																																																																																																																																																																																																																																																																																																																																																																																																																																																																																																																																																														
119	限位参数	limit_protect_jerk	jerk到限位jerk	mm/s³	2	2	2	40000																																																																																																																																																																																																																																																																																																																																																																																																																																																																																																																																																																																																																																																																																																																																																																																																																																																																																																																																																																																																																																																																																																																																																																																																																																																																																																														
120	限位参数	limit_protect_force	力到限位力	N	10	10	10	40000																																																																																																																																																																																																																																																																																																																																																																																																																																																																																																																																																																																																																																																																																																																																																																																																																																																																																																																																																																																																																																																																																																																																																																																																																																																																																																														
121	限位参数	limit_protect_torque	扭矩到限位扭矩	Nm	10	10	10	40000																																																																																																																																																																																																																																																																																																																																																																																																																																																																																																																																																																																																																																																																																																																																																																																																																																																																																																																																																																																																																																																																																																																																																																																																																																																																																																														
122	限位参数	limit_protect_current	电流到限位电流	A	10	10	10	40000																																																																																																																																																																																																																																																																																																																																																																																																																																																																																																																																																																																																																																																																																																																																																																																																																																																																																																																																																																																																																																																																																																																																																																																																																																																																																																														
123	限位参数	limit_protect_voltage	电压到限位电压	V	10	10	10	40000																																																																																																																																																																																																																																																																																																																																																																																																																																																																																																																																																																																																																																																																																																																																																																																																																																																																																																																																																																																																																																																																																																																																																																																																																																																																																																														
124	限位参数	limit_protect_temperature	温度到限位温度	°C	10	10	10	40000																																																																																																																																																																																																																																																																																																																																																																																																																																																																																																																																																																																																																																																																																																																																																																																																																																																																																																																																																																																																																																																																																																																																																																																																																																																																																																														
125	限位参数	limit_protect_position	位置到限位位置	mm	10	10	10	40000																																																																																																																																																																																																																																																																																																																																																																																																																																																																																																																																																																																																																																																																																																																																																																																																																																																																																																																																																																																																																																																																																																																																																																																																																																																																																																														
126	限位参数	limit_protect_speed	速度到限位速度	mm/s	10	10	10	40000																																																																																																																																																																																																																																																																																																																																																																																																																																																																																																																																																																																																																																																																																																																																																																																																																																																																																																																																																																																																																																																																																																																																																																																																																																																																																																														
127	限位参数	limit_protect_acc	加速度到限位加速度	mm/s²	10	10	10	40000																																																																																																																																																																																																																																																																																																																																																																																																																																																																																																																																																																																																																																																																																																																																																																																																																																																																																																																																																																																																																																																																																																																																																																																																																																																																																																														
128	限位参数	limit_protect_jerk	jerk到限位jerk	mm/s³	2	2	2	40000																																																																																																																																																																																																																																																																																																																																																																																																																																																																																																																																																																																																																																																																																																																																																																																																																																																																																																																																																																																																																																																																																																																																																																																																																																																																																																														
129	限位参数	limit_protect_force	力到限位力	N	10	10	10	40000																																																																																																																																																																																																																																																																																																																																																																																																																																																																																																																																																																																																																																																																																																																																																																																																																																																																																																																																																																																																																																																																																																																																																																																																																																																																																																														
130	限位参数	limit_protect_torque	扭矩到限位扭矩	Nm	10	10	10	40000																																																																																																																																																																																																																																																																																																																																																																																																																																																																																																																																																																																																																																																																																																																																																																																																																																																																																																																																																																																																																																																																																																																																																																																																																																																																																																														
131	限位参数	limit_protect_current	电流到限位电流	A	10	10	10	40000																																																																																																																																																																																																																																																																																																																																																																																																																																																																																																																																																																																																																																																																																																																																																																																																																																																																																																																																																																																																																																																																																																																																																																																																																																																																																																														
132	限位参数	limit_protect_voltage	电压到限位电压	V	10	10	10	40000																																																																																																																																																																																																																																																																																																																																																																																																																																																																																																																																																																																																																																																																																																																																																																																																																																																																																																																																																																																																																																																																																																																																																																																																																																																																																																														
133	限位参数	limit_protect_temperature	温度到限位温度	°C	10	10	10	40000																																																																																																																																																																																																																																																																																																																																																																																																																																																																																																																																																																																																																																																																																																																																																																																																																																																																																																																																																																																																																																																																																																																																																																																																																																																																																																														
134	限位参数	limit_protect_position	位置到限位位置	mm	10	10	10	40000																																																																																																																																																																																																																																																																																																																																																																																																																																																																																																																																																																																																																																																																																																																																																																																																																																																																																																																																																																																																																																																																																																																																																																																																																																																																																																														
135	限位参数	limit_protect_speed	速度到限位速度	mm/s	10	10	10	40000																																																																																																																																																																																																																																																																																																																																																																																																																																																																																																																																																																																																																																																																																																																																																																																																																																																																																																																																																																																																																																																																																																																																																																																																																																																																																																														
136	限位参数	limit_protect_acc	加速度到限位加速度	mm/s²	10	10	10	40000																																																																																																																																																																																																																																																																																																																																																																																																																																																																																																																																																																																																																																																																																																																																																																																																																																																																																																																																																																																																																																																																																																																																																																																																																																																																																																														
137	限位参数	limit_protect_jerk	jerk到限位jerk	mm/s³	2	2	2	40000																																																																																																																																																																																																																																																																																																																																																																																																																																																																																																																																																																																																																																																																																																																																																																																																																																																																																																																																																																																																																																																																																																																																																																																																																																																																																																														
138	限位参数	limit_protect_force	力到限位力	N	10	10	10	40000																																																																																																																																																																																																																																																																																																																																																																																																																																																																																																																																																																																																																																																																																																																																																																																																																																																																																																																																																																																																																																																																																																																																																																																																																																																																																																														
139	限位参数	limit_protect_torque	扭矩到限位扭矩	Nm	10	10	10	40000																																																																																																																																																																																																																																																																																																																																																																																																																																																																																																																																																																																																																																																																																																																																																																																																																																																																																																																																																																																																																																																																																																																																																																																																																																																																																																														
140	限位参数	limit_protect_current	电流到限位电流	A	10	10	10	40000																																																																																																																																																																																																																																																																																																																																																																																																																																																																																																																																																																																																																																																																																																																																																																																																																																																																																																																																																																																																																																																																																																																																																																																																																																																																																																														
141	限位参数	limit_protect_voltage	电压到限位电压	V	10	10	10	40000																																																																																																																																																																																																																																																																																																																																																																																																																																																																																																																																																																																																																																																																																																																																																																																																																																																																																																																																																																																																																																																																																																																																																																																																																																																																																																														
142	限位参数	limit_protect_temperature	温度到限位温度	°C	10	10	10	40000																																																																																																																																																																																																																																																																																																																																																																																																																																																																																																																																																																																																																																																																																																																																																																																																																																																																																																																																																																																																																																																																																																																																																																																																																																																																																																														
143	限位参数	limit_protect_position	位置到限位位置	mm	10	10	10	40000																																																																																																																																																																																																																																																																																																																																																																																																																																																																																																																																																																																																																																																																																																																																																																																																																																																																																																																																																																																																																																																																																																																																																																																																																																																																																																														
144	限位参数	limit_protect_speed	速度到限位速度	mm/s	10	10	10	40000																																																																																																																																																																																																																																																																																																																																																																																																																																																																																																																																																																																																																																																																																																																																																																																																																																																																																																																																																																																																																																																																																																																																																																																																																																																																																																														
145	限位参数	limit_protect_acc	加速度到限位加速度	mm/s²	10	10	10	40000																																																																																																																																																																																																																																																																																																																																																																																																																																																																																																																																																																																																																																																																																																																																																																																																																																																																																																																																																																																																																																																																																																																																																																																																																																																																																																														
146	限位参数	limit_protect_jerk	jerk到限位jerk	mm/s³	2	2	2	40000																																																																																																																																																																																																																																																																																																																																																																																																																																																																																																																																																																																																																																																																																																																																																																																																																																																																																																																																																																																																																																																																																																																																																																																																																																																																																																														
147	限位参数	limit_protect_force	力到限位力	N	10	10	10	40000																																																																																																																																																																																																																																																																																																																																																																																																																																																																																																																																																																																																																																																																																																																																																																																																																																																																																																																																																																																																																																																																																																																																																																																																																																																																																																														
148	限位参数	limit_protect_torque	扭矩到限位扭矩	Nm	10	10	10	40000																																																																																																																																																																																																																																																																																																																																																																																																																																																																																																																																																																																																																																																																																																																																																																																																																																																																																																																																																																																																																																																																																																																																																																																																																																																																																																														
149	限位参数	limit_protect_current	电流到限位电流	A	10	10	10	40000																																																																																																																																																																																																																																																																																																																																																																																																																																																																																																																																																																																																																																																																																																																																																																																																																																																																																																																																																																																																																																																																																																																																																																																																																																																																																																														
150	限位参数	limit_protect_voltage	电压到限位电压	V	10	10	10	40000																																																																																																																																																																																																																																																																																																																																																																																																																																																																																																																																																																																																																																																																																																																																																																																																																																																																																																																																																																																																																																																																																																																																																																																																																																																																																																														
151	限位参数	limit_protect_temperature	温度到限位温度	°C	10	10	10	40000																																																																																																																																																																																																																																																																																																																																																																																																																																																																																																																																																																																																																																																																																																																																																																																																																																																																																																																																																																																																																																																																																																																																																																																																																																																																																																														
152	限位参数	limit_protect_position	位置到限位位置	mm	10	10	10	40000																																																																																																																																																																																																																																																																																																																																																																																																																																																																																																																																																																																																																																																																																																																																																																																																																																																																																																																																																																																																																																																																																																																																																																																																																																																																																																														
153	限位参数	limit_protect_speed	速度到限位速度	mm/s	10	10	10	40000																																																																																																																																																																																																																																																																																																																																																																																																																																																																																																																																																																																																																																																																																																																																																																																																																																																																																																																																																																																																																																																																																																																																																																																																																																																																																																														
154	限位参数	limit_protect_acc	加速度到限位加速度	mm/s²	10	10	10	40000																																																																																																																																																																																																																																																																																																																																																																																																																																																																																																																																																																																																																																																																																																																																																																																																																																																																																																																																																																																																																																																																																																																																																																																																																																																																																																														
155	限位参数	limit_protect_jerk	jerk到限位jerk	mm/s³	2	2	2	40000																																																																																																																																																																																																																																																																																																																																																																																																																																																																																																																																																																																																																																																																																																																																																																																																																																																																																																																																																																																																																																																																																																																																																																																																																																																																																																														
156	限位参数	limit_protect_force	力到限位力	N	10	10	10	40000																																																																																																																																																																																																																																																																																																																																																																																																																																																																																																																																																																																																																																																																																																																																																																																																																																																																																																																																																																																																																																																																																																																																																																																																																																																																																																														
157	限位参数	limit_protect_torque	扭矩到限位扭矩	Nm	10	10	10	40000																																																																																																																																																																																																																																																																																																																																																																																																																																																																																																																																																																																																																																																																																																																																																																																																																																																																																																																																																																																																																																																																																																																																																																																																																																																																																																														
158	限位参数	limit_protect_current	电流到限位电流	A	10	10	10	40000																																																																																																																																																																																																																																																																																																																																																																																																																																																																																																																																																																																																																																																																																																																																																																																																																																																																																																																																																																																																																																																																																																																																																																																																																																																																																																														
159	限位参数	limit_protect_voltage	电压到限位电压	V	10	10	10	40000																																																																																																																																																																																																																																																																																																																																																																																																																																																																																																																																																																																																																																																																																																																																																																																																																																																																																																																																																																																																																																																																																																																																																																																																																																																																																																														
160	限位参数	limit_protect_temperature	温度到限位温度	°C	10	10	10	40000																																																																																																																																																																																																																																																																																																																																																																																																																																																																																																																																																																																																																																																																																																																																																																																																																																																																																																																																																																																																																																																																																																																																																																																																																																																																																																														
161	限位参数	limit_protect_position	位置到限位位置	mm	10	10	10	40000																																																																																																																																																																																																																																																																																																																																																																																																																																																																																																																																																																																																																																																																																																																																																																																																																																																																																																																																																																																																																																																																																																																																																																																																																																																																																																														
162	限位参数	limit_protect_speed	速度到限位速度	mm/s	10	10	10	40000																																																																																																																																																																																																																																																																																																																																																																																																																																																																																																																																																																																																																																																																																																																																																																																																																																																																																																																																																																																																																																																																																																																																																																																																																																																																																																														
163	限位参数	limit_protect_acc	加速度到限位加速度	mm/s²	10	10	10	40000																																																																																																																																																																																																																																																																																																																																																																																																																																																																																																																																																																																																																																																																																																																																																																																																																																																																																																																																																																																																																																																																																																																																																																																																																																																																																																														
164	限位参数	limit_protect_jerk	jerk到限位jerk	mm/s³	2	2	2	40000																																																																																																																																																																																																																																																																																																																																																																																																																																																																																																																																																																																																																																																																																																																																																																																																																																																																																																																																																																																																																																																																																																																																																																																																																																																																																																														
165	限位参数	limit_protect_force	力到限位力	N	10	10	10	40000																																																																																																																																																																																																																																																																																																																																																																																																																																																																																																																																																																																																																																																																																																																																																																																																																																																																																																																																																																																																																																																																																																																																																																																																																																																																																																														
166	限位参数	limit_protect_torque	扭矩到限位扭矩	Nm	10	10	10	40000																																																																																																																																																																																																																																																																																																																																																																																																																																																																																																																																																																																																																																																																																																																																																																																																																																																																																																																																																																																																																																																																																																																																																																																																																																																																																																														
167	限位参数	limit_protect_current	电流到限位电流	A	10	10	10	40000																																																																																																																																																																																																																																																																																																																																																																																																																																																																																																																																																																																																																																																																																																																																																																																																																																																																																																																																																																																																																																																																																																																																																																																																																																																																																																														
168	限位参数	limit_protect_voltage	电压到限位电压	V	10	10	10	40000																																																																																																																																																																																																																																																																																																																																																																																																																																																																																																																																																																																																																																																																																																																																																																																																																																																																																																																																																																																																																																																																																																																																																																																																																																																																																																														
169	限位参数	limit_protect_temperature	温度到限位温度	°C	10	10	10	40000																																																																																																																																																																																																																																																																																																																																																																																																																																																																																																																																																																																																																																																																																																																																																																																																																																																																																																																																																																																																																																																																																																																																																																																																																																																																																																														
170	限位参数	limit_protect_position	位置到限位位置	mm	10	10	10	40000																																																																																																																																																																																																																																																																																																																																																																																																																																																																																																																																																																																																																																																																																																																																																																																																																																																																																																																																																																																																																																																																																																																																																																																																																																																																																																														
171	限位参数	limit_protect_speed	速度到限位速度	mm/s	10	10	10	40000																																																																																																																																																																																																																																																																																																																																																																																																																																																																																																																																																																																																																																																																																																																																																																																																																																																																																																																																																																																																																																																																																																																																																																																																																																																																																																														
172	限位参数	limit_protect_acc	加速度到限位加速度	mm/s²	10	10	10	40000																																																																																																																																																																																																																																																																																																																																																																																																																																																																																																																																																																																																																																																																																																																																																																																																																																																																																																																																																																																																																																																																																																																																																																																																																																																																																																														
173	限位参数	limit_protect_jerk	jerk到限位jerk	mm/s³	2	2	2	40000																																																																																																																																																																																																																																																																																																																																																																																																																																																																																																																																																																																																																																																																																																																																																																																																																																																																																																																																																																																																																																																																																																																																																																																																																																																																																																														
174	限位参数	limit_protect_force	力到限位力	N	10	10	10	40000																																																																																																																																																																																																																																																																																																																																																																																																																																																																																																																																																																																																																																																																																																																																																																																																																																																																																																																																																																																																																																																																																																																																																																																																																																																																																																														
175	限位参数	limit_protect_torque	扭矩到限位扭矩	Nm	10	10	10	40000																																																																																																																																																																																																																																																																																																																																																																																																																																																																																																																																																																																																																																																																																																																																																																																																																																																																																																																																																																																																																																																																																																																																																																																																																																																																																																														
176	限位参数	limit_protect_current	电流到限位电流	A	10	10	10	40000																																																																																																																																																																																																																																																																																																																																																																																																																																																																																																																																																																																																																																																																																																																																																																																																																																																																																																																																																																																																																																																																																																																																																																																																																																																																																																														
177	限位参数	limit_protect_voltage	电压到限位电压	V	10	10	10	40000																																																																																																																																																																																																																																																																																																																																																																																																																																																																																																																																																																																																																																																																																																																																																																																																																																																																																																																																																																																																																																																																																																																																																																																																																																																																																																														
178	限位参数	limit_protect_temperature	温度到限位温度	°C	10	10	10	40000																																																																																																																																																																																																																																																																																																																																																																																																																																																																																																																																																																																																																																																																																																																																																																																																																																																																																																																																																																																																																																																																																																																																																																																																																																																																																																														
179	限位参数	limit_protect_position	位置到限位位置	mm	10	10	10	40000																																																																																																																																																																																																																																																																																																																																																																																																																																																																																																																																																																																																																																																																																																																																																																																																																																																																																																																																																																																																																																																																																																																																																																																																																																																																																																														
180	限位参数	limit_protect_speed	速度到限位速度	mm/s	10	10	10	40000																																																																																																																																																																																																																																																																																																																																																																																																																																																																																																																																																																																																																																																																																																																																																																																																																																																																																																																																																																																																																																																																																																																																																																																																																																																																																																														
181	限位参数	limit_protect_acc	加速度到限位加速度	mm/s²	10	10	10	40000																																																																																																																																																																																																																																																																																																																																																																																																																																																																																																																																																																																																																																																																																																																																																																																																																																																																																																																																																																																																																																																																																																																																																																																																																																																																																																														
182	限位参数	limit_protect_jerk	jerk到限位jerk	mm/s³	2	2	2	40000																																																																																																																																																																																																																																																																																																																																																																																																																																																																																																																																																																																																																																																																																																																																																																																																																																																																																																																																																																																																																																																																																																																																																																																																																																																																																																														
183	限位参数	limit_protect_force	力到限位力	N	10	10	10	40000																																																																																																																																																																																																																																																																																																																																																																																																																																																																																																																																																																																																																																																																																																																																																																																																																																																																																																																																																																																																																																																																																																																																																																																																																																																																																																														
184	限位参数	limit_protect_torque	扭矩到限位扭矩	Nm	10	10	10	40000																																																																																																																																																																																																																																																																																																																																																																																																																																																																																																																																																																																																																																																																																																																																																																																																																																																																																																																																																																																																																																																																																																																																																																																																																																																																																																														
185	限位参数	limit_protect_current	电流到限位电流	A	10	10	10	40000																																																																																																																																																																																																																																																																																																																																																																																																																																																																																																																																																																																																																																																																																																																																																																																																																																																																																																																																																																																																																																																																																																																																																																																																																																																																																																														
186	限位参数	limit_protect_voltage	电压到限位电压	V	10	10	10	40000																																																																																																																																																																																																																																																																																																																																																																																																																																																																																																																																																																																																																																																																																																																																																																																																																																																																																																																																																																																																																																																																																																																																																																																																																																																																																																														
187	限位参数	limit_protect_temperature	温度到限位温度	°C	10	10	10	40000																																																																																																																																																																																																																																																																																																																																																																																																																																																																																																																																																																																																																																																																																																																																																																																																																																																																																																																																																																																																																																																																																																																																																																																																																																																																																																														
188	限位参数	limit_protect_position	位置到限位位置	mm	10	10	10	40000																																																																																																																																																																																																																																																																																																																																																																																																																																																																																																																																																																																																																																																																																																																																																																																																																																																																																																																																																																																																																																																																																																																																																																																																																																																																																																														
189	限位参数	limit_protect_speed	速度到限位速度	mm/s	10	10	10	40000																																																																																																																																																																																																																																																																																																																																																																																																																																																																																																																																																																																																																																																																																																																																																																																																																																																																																																																																																																																																																																																																																																																																																																																																																																																																																																														
190	限位参数	limit_protect_acc	加速度到限位加速度	mm/s²	10	10	10	40000																																																																																																																																																																																																																																																																																																																																																																																																																																																																																																																																																																																																																																																																																																																																																																																																																																																																																																																																																																																																																																																																																																																																																																																																																																																																																																														
191	限位参数	limit_protect_jerk	jerk到限位jerk	mm/s³	2	2	2	40000																																																																																																																																																																																																																																																																																																																																																																																																																																																																																																																																																																																																																																																																																																																																																																																																																																																																																																																																																																																																																																																																																																																																																																																																																																																																																																														
192	限位参数	limit_protect_force	力到限位力	N	10	10	10	40000																																																																																																																																																																																																																																																																																																																																																																																																																																																																																																																																																																																																																																																																																																																																																																																																																																																																																																																																																																																																																																																																																																																																																																																																																																																																																																														
193	限位参数	limit_protect_torque	扭矩到限位扭矩	Nm	10	10	10	40000																																																																																																																																																																																																																																																																																																																																																																																																																																																																																																																																																																																																																																																																																																																																																																																																																																																																																																																																																																																																																																																																																																																																																																																																																																																																																																														
194	限位参数	limit_protect_current	电流到限位电流	A	10	10	10	40000																																																																																																																																																																																																																																																																																																																																																																																																																																																																																																																																																																																																																																																																																																																																																																																																																																																																																																																																																																																																																																																																																																																																																																																																																																																																																																														
195	限位参数	limit_protect_voltage	电压到限位电压	V	10	10	10	40000																																																																																																																																																																																																																																																																																																																																																																																																																																																																																																																																																																																																																																																																																																																																																																																																																																																																																																																																																																																																																																																																																																																																																																																																																																																																																																														
196	限位参数	limit_protect_temperature	温度到限位温度	°C	10	10	10	40000																																																																																																																																																																																																																																																																																																																																																																																																																																																																																																																																																																																																																																																																																																																																																																																																																																																																																																																																																																																																																																																																																																																																																																																																																																																																																																														
197	限位参数	limit_protect_position	位置到限位位置	mm	10	10	10	40000																																																																																																																																																																																																																																																																																																																																																																																																																																																																																																																																																																																																																																																																																																																																																																																																																																																																																																																																																																																																																																																																																																																																																																																																																																																																																																														
198	限位参数	limit_protect_speed	速度到限位速度	mm/s	10	10	10	40000																																																																																																																																																																																																																																																																																																																																																																																																																																																																																																																																																																																																																																																																																																																																																																																																																																																																																																																																																																																																																																																																																																																																																																																																																																																																																																														
199	限位参数	limit_protect_acc	加速度到限位加速度	mm/s²	10	10	10	40000																																																																																																																																																																																																																																																																																																																																																																																																																																																																																																																																																																																																																																																																																																																																																																																																																																																																																																																																																																																																																																																																																																																																																																																																																																																																																																														
200	限位参数	limit_protect_jerk	jerk到限位jerk	mm/s³	2	2	2	40000																																																																																																																																																																																																																																																																																																																																																																																																																																																																																																																																																																																																																																																																																																																																																																																																																																																																																																																																																																																																																																																																																																																																																																																																																																																																																																														
2、设置参数 limit_switch_polarity = 0(常开型) 或 = 1(常闭型) 根据硬件开关输出极性设置常开型或常闭型。																																																																																																																																																																																																																																																																																																																																																																																																																																																																																																																																																																																																																																																																																																																																																																																																																																																																																																																																																																																																																																																																																																																																																																																																																																																																																																																						
3、参数 homing_method = 1 使用限位回零。																																																																																																																																																																																																																																																																																																																																																																																																																																																																																																																																																																																																																																																																																																																																																																																																																																																																																																																																																																																																																																																																																																																																																																																																																																																																																																																						
4、参数 homing_use_z_signal = 1 开启 z 信号辅助回零。																																																																																																																																																																																																																																																																																																																																																																																																																																																																																																																																																																																																																																																																																																																																																																																																																																																																																																																																																																																																																																																																																																																																																																																																																																																																																																																						
5、ModePos = 4 使设备运动模式切换到主动回零模式并使能。																																																																																																																																																																																																																																																																																																																																																																																																																																																																																																																																																																																																																																																																																																																																																																																																																																																																																																																																																																																																																																																																																																																																																																																																																																																																																																																						
6、CancelTraversing = TRUE 让设备不暂停任务。																																																																																																																																																																																																																																																																																																																																																																																																																																																																																																																																																																																																																																																																																																																																																																																																																																																																																																																																																																																																																																																																																																																																																																																																																																																																																																																						
7、IntermediateStop = TRUE 让设备不取消任务。																																																																																																																																																																																																																																																																																																																																																																																																																																																																																																																																																																																																																																																																																																																																																																																																																																																																																																																																																																																																																																																																																																																																																																																																																																																																																																																						
8、EnableAxis=1 让电机使能。																																																																																																																																																																																																																																																																																																																																																																																																																																																																																																																																																																																																																																																																																																																																																																																																																																																																																																																																																																																																																																																																																																																																																																																																																																																																																																																						
9、等待时间 X 确保参数传输完毕, X 应大于 2 倍数据周期时间。IO 周期时间参考 I/O 周期																																																																																																																																																																																																																																																																																																																																																																																																																																																																																																																																																																																																																																																																																																																																																																																																																																																																																																																																																																																																																																																																																																																																																																																																																																																																																																																						
10、ExecuteMode = TRUE 该信号上升沿时启动任务,设备按照参数表设定的回零参数执行主动回零。																																																																																																																																																																																																																																																																																																																																																																																																																																																																																																																																																																																																																																																																																																																																																																																																																																																																																																																																																																																																																																																																																																																																																																																																																																																																																																																						

8.1.5.3.3.3.5 零点设置模式

零点设置模式	
步骤	图示
1、ModePos = 5 运动模式切换到零点设置模式。	
2、CancelTraversing = TRUE 让设备不暂停任务。	
3、IntermediateStop = TRUE 让设备不取消任务。	
4、EnableAxis=1 让电机使能。	
5、等待时间 X 确保参数传输完毕, X 应大于 2 倍数据周期时间。IO 周期时间参考 I/O 周期	
6、ExecuteMode = TRUE 该信号上升沿时启动任务,设备将当前的位置设置为零点。	

8.1.5.3.3.3.6 程序块模式

8.1.5.3.3.3.6.1 单次运行模式

程序块模式-单次运行模式	
步骤	图示
1、参数 program_block_operation_mode = 0 程序块运行模式设置为单次运行模式。	
2、参数 program_block_start_step = 1 程序块起始步设置为 1。	
3、参数 program_block_end_step = 2 程序块结束步设置为 2。	
4、参数 program_block_step[1].Xtarget = 0 程序步 1 目标位置设置为 0 lu。	
5、参数 program_block_step[1].Vtarget = 5000 程序步 1 目标速度设置为 5000 lu/s。	
6、参数 program_block_step[1].delay = 500 程序步 1 延时设置为 500 ms。	
7、参数 program_block_step[2].Xtarget = 10000 程序步 2 目标位置设置为 10000 lu。	
8、参数 program_block_step[2].Vtarget = 5000 程序步 2 目标速度设置为 5000 lu/s。	
9、参数 program_block_step[2].delay = 500 程序步 2 延时设置为 500 ms。	
10、检查 AxisRef 等于 TRUE 确认轴已回零。设备程序块模式需要零点作为参考点。	
11、ModePos = 6 运动模式切换到程序块模式。	
12、CancelTraversing = TRUE 让设备不暂停任务。	
13、IntermediateStop = TRUE 让设备不取消任务。	
14、TransferType = TRUE (按需设定) 开启设定值连续传输，使程序步的当前步完成后继续执行下一步。	
15、EnableAxis=1 让电机使能。	
16、等待时间 X 确保参数传输完毕，X 应大于 2 倍数据周期时间。IO 周期时间参考 I/O 周期	
17、ExecuteMode = TRUE 该信号上升沿时启动任务,设备按照程序块参数执行程序块模式运动。	

8.1.5.3.3.6.2 循环运行模式

程序块模式-循环运行模式	
步骤	图示
1、软件参数 program_block_operation_mode = 1 程序块运行模式设置为循环运行模式。	
2、软件参数 program_block_start_step = 1 程序块起始步设置为 1。	
3、软件参数 program_block_end_step = 2 程序块结束步设置为 2。	
4、软件参数 program_block_step[1].Xtarget = 0 程序步 1 目标位置设置为 0 lu。	
5、软件参数 program_block_step[1].Vtarget = 5000 程序步 1 目标速度设置为 5000 lu/s。	
6、软件参数 program_block_step[1].delay = 500 程序步 1 延时设置为 500 ms。	
7、软件参数 program_block_step[2].Xtarget = 10000 程序步 2 目标位置设置为 10000 lu。	
8、软件参数 program_block_step[2].Vtarget = 5000 程序步 2 目标速度设置为 5000 lu/s。	
9、软件参数 program_block_step[2].delay = 500 程序步 2 延时设置为 500 ms。	
10、检查 AxisRef 等于 TRUE 确认轴已回零。设备程序块模式需要零点作为参考点。	
11、ModePos = 6 运动模式切换到程序块模式。	
12、CancelTraversing = TRUE 让设备不暂停任务。	
13、IntermediateStop = TRUE 让设备不取消任务。	
14、TransferType = TRUE (按需设定) 开启设定值连续传输，使程序步当前步完成后继续执行下一步。	
15、EnableAxis=1 让电机使能。	
16、等待时间 X 确保参数传输完毕，X 应大于 2 倍数据周期时间。IO 周期时间参考 I/O 周期	
17、ExecuteMode = TRUE 该信号上升沿时启动任务,设备按照程序块参数执行程序块模式运动。	

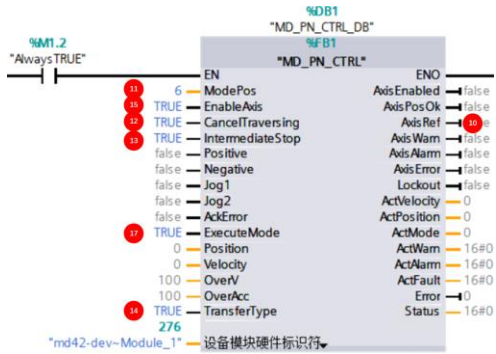

8.1.5.3.3.3.7 点动模式

点动模式																																																																																																																																																																																																																																																																																																																																																																																																																																					
步骤	图示																																																																																																																																																																																																																																																																																																																																																																																																																																				
<p>1、参数 jog_velocity = 60 设置点动速度为 60rpm。</p>	<table border="1"> <thead> <tr> <th>参数号</th> <th>变量地址</th> <th>参数名</th> <th>描述</th> <th>设置值</th> <th>初始值</th> <th>出厂值</th> <th>最小值</th> <th>最大值</th> <th>单位</th> </tr> </thead> <tbody> <tr> <td>110</td> <td>寄存器</td> <td> jogging_vel_1_speed</td> <td>1号轴点动速度</td> <td>60</td> <td>60</td> <td>1</td> <td>0</td> <td>1</td> <td>rpm</td> </tr> <tr> <td>112</td> <td>寄存器</td> <td> jogging_velicity_1</td> <td>1号轴点动速度</td> <td>60</td> <td>60</td> <td>1</td> <td>0</td> <td>1</td> <td>rpm</td> </tr> <tr> <td>114</td> <td>寄存器</td> <td> jogging_velicity2</td> <td>2号轴点动速度</td> <td>10</td> <td>10</td> <td>10</td> <td>1</td> <td>100</td> <td>rpm</td> </tr> <tr> <td>116</td> <td>寄存器</td> <td> jogging_velicity3</td> <td>3号轴点动速度</td> <td>10</td> <td>10</td> <td>10</td> <td>1</td> <td>100</td> <td>rpm</td> </tr> <tr> <td>118</td> <td>寄存器</td> <td> jogging_velicity4</td> <td>4号轴点动速度</td> <td>10</td> <td>10</td> <td>10</td> <td>1</td> <td>100</td> <td>rpm</td> </tr> <tr> <td>120</td> <td>寄存器</td> <td> jogging_velicity5</td> <td>5号轴点动速度</td> <td>10</td> <td>10</td> <td>10</td> <td>1</td> <td>100</td> <td>rpm</td> </tr> <tr> <td>122</td> <td>寄存器</td> <td> jogging_velicity6</td> <td>6号轴点动速度</td> <td>10</td> <td>10</td> <td>10</td> <td>1</td> <td>100</td> <td>rpm</td> </tr> <tr> <td>124</td> <td>寄存器</td> <td> jogging_velicity7</td> <td>7号轴点动速度</td> <td>10</td> <td>10</td> <td>10</td> <td>1</td> <td>100</td> <td>rpm</td> </tr> <tr> <td>126</td> <td>寄存器</td> <td> jogging_velicity8</td> <td>8号轴点动速度</td> <td>10</td> <td>10</td> <td>10</td> <td>1</td> <td>100</td> <td>rpm</td> </tr> <tr> <td>128</td> <td>寄存器</td> <td> jogging_velicity9</td> <td>9号轴点动速度</td> <td>10</td> <td>10</td> <td>10</td> <td>1</td> <td>100</td> <td>rpm</td> </tr> <tr> <td>130</td> <td>寄存器</td> <td> jogging_velicity10</td> <td>10号轴点动速度</td> <td>10</td> <td>10</td> <td>10</td> <td>1</td> <td>100</td> <td>rpm</td> </tr> <tr> <td>132</td> <td>寄存器</td> <td> jogging_velicity11</td> <td>11号轴点动速度</td> <td>10</td> <td>10</td> <td>10</td> <td>1</td> <td>100</td> <td>rpm</td> </tr> <tr> <td>134</td> <td>寄存器</td> <td> jogging_velicity12</td> <td>12号轴点动速度</td> <td>10</td> <td>10</td> <td>10</td> <td>1</td> <td>100</td> <td>rpm</td> </tr> <tr> <td>136</td> <td>寄存器</td> <td> jogging_velicity13</td> <td>13号轴点动速度</td> <td>10</td> <td>10</td> <td>10</td> <td>1</td> <td>100</td> <td>rpm</td> </tr> <tr> <td>138</td> <td>寄存器</td> <td> jogging_velicity14</td> <td>14号轴点动速度</td> <td>10</td> <td>10</td> <td>10</td> <td>1</td> <td>100</td> <td>rpm</td> </tr> <tr> <td>140</td> <td>寄存器</td> <td> jogging_velicity15</td> <td>15号轴点动速度</td> <td>10</td> <td>10</td> <td>10</td> <td>1</td> <td>100</td> <td>rpm</td> </tr> <tr> <td>142</td> <td>寄存器</td> <td> jogging_velicity16</td> <td>16号轴点动速度</td> <td>10</td> <td>10</td> <td>10</td> <td>1</td> <td>100</td> <td>rpm</td> </tr> <tr> <td>144</td> <td>寄存器</td> <td> jogging_velicity17</td> <td>17号轴点动速度</td> <td>10</td> <td>10</td> <td>10</td> <td>1</td> <td>100</td> <td>rpm</td> </tr> <tr> <td>146</td> <td>寄存器</td> <td> jogging_velicity18</td> <td>18号轴点动速度</td> <td>10</td> <td>10</td> <td>10</td> <td>1</td> <td>100</td> <td>rpm</td> </tr> <tr> <td>148</td> <td>寄存器</td> <td> jogging_velicity19</td> <td>19号轴点动速度</td> <td>10</td> <td>10</td> <td>10</td> <td>1</td> <td>100</td> <td>rpm</td> </tr> <tr> <td>150</td> <td>寄存器</td> <td> jogging_velicity20</td> <td>20号轴点动速度</td> <td>10</td> <td>10</td> <td>10</td> <td>1</td> <td>100</td> <td>rpm</td> </tr> <tr> <td>152</td> <td>寄存器</td> <td> jogging_velicity21</td> <td>21号轴点动速度</td> <td>10</td> <td>10</td> <td>10</td> <td>1</td> <td>100</td> <td>rpm</td> </tr> <tr> <td>154</td> <td>寄存器</td> <td> jogging_velicity22</td> <td>22号轴点动速度</td> <td>10</td> <td>10</td> <td>10</td> <td>1</td> <td>100</td> <td>rpm</td> </tr> <tr> <td>156</td> <td>寄存器</td> <td> jogging_velicity23</td> <td>23号轴点动速度</td> <td>10</td> <td>10</td> <td>10</td> <td>1</td> <td>100</td> <td>rpm</td> </tr> <tr> <td>158</td> <td>寄存器</td> <td> jogging_velicity24</td> <td>24号轴点动速度</td> <td>10</td> <td>10</td> <td>10</td> <td>1</td> <td>100</td> <td>rpm</td> </tr> <tr> <td>160</td> <td>寄存器</td> <td> jogging_velicity25</td> <td>25号轴点动速度</td> <td>10</td> <td>10</td> <td>10</td> <td>1</td> <td>100</td> <td>rpm</td> </tr> <tr> <td>162</td> <td>寄存器</td> <td> jogging_velicity26</td> <td>26号轴点动速度</td> <td>10</td> <td>10</td> <td>10</td> <td>1</td> <td>100</td> <td>rpm</td> </tr> <tr> <td>164</td> <td>寄存器</td> <td> jogging_velicity27</td> <td>27号轴点动速度</td> <td>10</td> <td>10</td> <td>10</td> <td>1</td> <td>100</td> <td>rpm</td> </tr> <tr> <td>166</td> <td>寄存器</td> <td> jogging_velicity28</td> <td>28号轴点动速度</td> <td>10</td> <td>10</td> <td>10</td> <td>1</td> <td>100</td> <td>rpm</td> </tr> <tr> <td>168</td> <td>寄存器</td> <td> jogging_velicity29</td> <td>29号轴点动速度</td> <td>10</td> <td>10</td> <td>10</td> <td>1</td> <td>100</td> <td>rpm</td> </tr> <tr> <td>170</td> <td>寄存器</td> <td> jogging_velicity30</td> <td>30号轴点动速度</td> <td>10</td> <td>10</td> <td>10</td> <td>1</td> <td>100</td> <td>rpm</td> </tr> <tr> <td>172</td> <td>寄存器</td> <td> jogging_velicity31</td> <td>31号轴点动速度</td> <td>10</td> <td>10</td> <td>10</td> <td>1</td> <td>100</td> <td>rpm</td> </tr> <tr> <td>174</td> <td>寄存器</td> <td> jogging_velicity32</td> <td>32号轴点动速度</td> <td>10</td> <td>10</td> <td>10</td> <td>1</td> <td>100</td> <td>rpm</td> </tr> <tr> <td>176</td> <td>寄存器</td> <td> jogging_velicity33</td> <td>33号轴点动速度</td> <td>10</td> <td>10</td> <td>10</td> <td>1</td> <td>100</td> <td>rpm</td> </tr> <tr> <td>178</td> <td>寄存器</td> <td> jogging_velicity34</td> <td>34号轴点动速度</td> <td>10</td> <td>10</td> <td>10</td> <td>1</td> <td>100</td> <td>rpm</td> </tr> <tr> <td>180</td> <td>寄存器</td> <td> jogging_velicity35</td> <td>35号轴点动速度</td> <td>10</td> <td>10</td> <td>10</td> <td>1</td> <td>100</td> <td>rpm</td> </tr> <tr> <td>182</td> <td>寄存器</td> <td> jogging_velicity36</td> <td>36号轴点动速度</td> <td>10</td> <td>10</td> <td>10</td> <td>1</td> <td>100</td> <td>rpm</td> </tr> <tr> <td>184</td> <td>寄存器</td> <td> jogging_velicity37</td> <td>37号轴点动速度</td> <td>10</td> <td>10</td> <td>10</td> <td>1</td> <td>100</td> <td>rpm</td> </tr> <tr> <td>186</td> <td>寄存器</td> <td> jogging_velicity38</td> <td>38号轴点动速度</td> <td>10</td> <td>10</td> <td>10</td> <td>1</td> <td>100</td> <td>rpm</td> </tr> <tr> <td>188</td> <td>寄存器</td> <td> jogging_velicity39</td> <td>39号轴点动速度</td> <td>10</td> <td>10</td> <td>10</td> <td>1</td> <td>100</td> <td>rpm</td> </tr> <tr> <td>190</td> <td>寄存器</td> <td> jogging_velicity40</td> <td>40号轴点动速度</td> <td>10</td> <td>10</td> <td>10</td> <td>1</td> <td>100</td> <td>rpm</td> </tr> </tbody> </table>	参数号	变量地址	参数名	描述	设置值	初始值	出厂值	最小值	最大值	单位	110	寄存器	jogging_vel_1_speed	1号轴点动速度	60	60	1	0	1	rpm	112	寄存器	jogging_velicity_1	1号轴点动速度	60	60	1	0	1	rpm	114	寄存器	jogging_velicity2	2号轴点动速度	10	10	10	1	100	rpm	116	寄存器	jogging_velicity3	3号轴点动速度	10	10	10	1	100	rpm	118	寄存器	jogging_velicity4	4号轴点动速度	10	10	10	1	100	rpm	120	寄存器	jogging_velicity5	5号轴点动速度	10	10	10	1	100	rpm	122	寄存器	jogging_velicity6	6号轴点动速度	10	10	10	1	100	rpm	124	寄存器	jogging_velicity7	7号轴点动速度	10	10	10	1	100	rpm	126	寄存器	jogging_velicity8	8号轴点动速度	10	10	10	1	100	rpm	128	寄存器	jogging_velicity9	9号轴点动速度	10	10	10	1	100	rpm	130	寄存器	jogging_velicity10	10号轴点动速度	10	10	10	1	100	rpm	132	寄存器	jogging_velicity11	11号轴点动速度	10	10	10	1	100	rpm	134	寄存器	jogging_velicity12	12号轴点动速度	10	10	10	1	100	rpm	136	寄存器	jogging_velicity13	13号轴点动速度	10	10	10	1	100	rpm	138	寄存器	jogging_velicity14	14号轴点动速度	10	10	10	1	100	rpm	140	寄存器	jogging_velicity15	15号轴点动速度	10	10	10	1	100	rpm	142	寄存器	jogging_velicity16	16号轴点动速度	10	10	10	1	100	rpm	144	寄存器	jogging_velicity17	17号轴点动速度	10	10	10	1	100	rpm	146	寄存器	jogging_velicity18	18号轴点动速度	10	10	10	1	100	rpm	148	寄存器	jogging_velicity19	19号轴点动速度	10	10	10	1	100	rpm	150	寄存器	jogging_velicity20	20号轴点动速度	10	10	10	1	100	rpm	152	寄存器	jogging_velicity21	21号轴点动速度	10	10	10	1	100	rpm	154	寄存器	jogging_velicity22	22号轴点动速度	10	10	10	1	100	rpm	156	寄存器	jogging_velicity23	23号轴点动速度	10	10	10	1	100	rpm	158	寄存器	jogging_velicity24	24号轴点动速度	10	10	10	1	100	rpm	160	寄存器	jogging_velicity25	25号轴点动速度	10	10	10	1	100	rpm	162	寄存器	jogging_velicity26	26号轴点动速度	10	10	10	1	100	rpm	164	寄存器	jogging_velicity27	27号轴点动速度	10	10	10	1	100	rpm	166	寄存器	jogging_velicity28	28号轴点动速度	10	10	10	1	100	rpm	168	寄存器	jogging_velicity29	29号轴点动速度	10	10	10	1	100	rpm	170	寄存器	jogging_velicity30	30号轴点动速度	10	10	10	1	100	rpm	172	寄存器	jogging_velicity31	31号轴点动速度	10	10	10	1	100	rpm	174	寄存器	jogging_velicity32	32号轴点动速度	10	10	10	1	100	rpm	176	寄存器	jogging_velicity33	33号轴点动速度	10	10	10	1	100	rpm	178	寄存器	jogging_velicity34	34号轴点动速度	10	10	10	1	100	rpm	180	寄存器	jogging_velicity35	35号轴点动速度	10	10	10	1	100	rpm	182	寄存器	jogging_velicity36	36号轴点动速度	10	10	10	1	100	rpm	184	寄存器	jogging_velicity37	37号轴点动速度	10	10	10	1	100	rpm	186	寄存器	jogging_velicity38	38号轴点动速度	10	10	10	1	100	rpm	188	寄存器	jogging_velicity39	39号轴点动速度	10	10	10	1	100	rpm	190	寄存器	jogging_velicity40	40号轴点动速度	10	10	10	1	100	rpm
参数号	变量地址	参数名	描述	设置值	初始值	出厂值	最小值	最大值	单位																																																																																																																																																																																																																																																																																																																																																																																																																												
110	寄存器	jogging_vel_1_speed	1号轴点动速度	60	60	1	0	1	rpm																																																																																																																																																																																																																																																																																																																																																																																																																												
112	寄存器	jogging_velicity_1	1号轴点动速度	60	60	1	0	1	rpm																																																																																																																																																																																																																																																																																																																																																																																																																												
114	寄存器	jogging_velicity2	2号轴点动速度	10	10	10	1	100	rpm																																																																																																																																																																																																																																																																																																																																																																																																																												
116	寄存器	jogging_velicity3	3号轴点动速度	10	10	10	1	100	rpm																																																																																																																																																																																																																																																																																																																																																																																																																												
118	寄存器	jogging_velicity4	4号轴点动速度	10	10	10	1	100	rpm																																																																																																																																																																																																																																																																																																																																																																																																																												
120	寄存器	jogging_velicity5	5号轴点动速度	10	10	10	1	100	rpm																																																																																																																																																																																																																																																																																																																																																																																																																												
122	寄存器	jogging_velicity6	6号轴点动速度	10	10	10	1	100	rpm																																																																																																																																																																																																																																																																																																																																																																																																																												
124	寄存器	jogging_velicity7	7号轴点动速度	10	10	10	1	100	rpm																																																																																																																																																																																																																																																																																																																																																																																																																												
126	寄存器	jogging_velicity8	8号轴点动速度	10	10	10	1	100	rpm																																																																																																																																																																																																																																																																																																																																																																																																																												
128	寄存器	jogging_velicity9	9号轴点动速度	10	10	10	1	100	rpm																																																																																																																																																																																																																																																																																																																																																																																																																												
130	寄存器	jogging_velicity10	10号轴点动速度	10	10	10	1	100	rpm																																																																																																																																																																																																																																																																																																																																																																																																																												
132	寄存器	jogging_velicity11	11号轴点动速度	10	10	10	1	100	rpm																																																																																																																																																																																																																																																																																																																																																																																																																												
134	寄存器	jogging_velicity12	12号轴点动速度	10	10	10	1	100	rpm																																																																																																																																																																																																																																																																																																																																																																																																																												
136	寄存器	jogging_velicity13	13号轴点动速度	10	10	10	1	100	rpm																																																																																																																																																																																																																																																																																																																																																																																																																												
138	寄存器	jogging_velicity14	14号轴点动速度	10	10	10	1	100	rpm																																																																																																																																																																																																																																																																																																																																																																																																																												
140	寄存器	jogging_velicity15	15号轴点动速度	10	10	10	1	100	rpm																																																																																																																																																																																																																																																																																																																																																																																																																												
142	寄存器	jogging_velicity16	16号轴点动速度	10	10	10	1	100	rpm																																																																																																																																																																																																																																																																																																																																																																																																																												
144	寄存器	jogging_velicity17	17号轴点动速度	10	10	10	1	100	rpm																																																																																																																																																																																																																																																																																																																																																																																																																												
146	寄存器	jogging_velicity18	18号轴点动速度	10	10	10	1	100	rpm																																																																																																																																																																																																																																																																																																																																																																																																																												
148	寄存器	jogging_velicity19	19号轴点动速度	10	10	10	1	100	rpm																																																																																																																																																																																																																																																																																																																																																																																																																												
150	寄存器	jogging_velicity20	20号轴点动速度	10	10	10	1	100	rpm																																																																																																																																																																																																																																																																																																																																																																																																																												
152	寄存器	jogging_velicity21	21号轴点动速度	10	10	10	1	100	rpm																																																																																																																																																																																																																																																																																																																																																																																																																												
154	寄存器	jogging_velicity22	22号轴点动速度	10	10	10	1	100	rpm																																																																																																																																																																																																																																																																																																																																																																																																																												
156	寄存器	jogging_velicity23	23号轴点动速度	10	10	10	1	100	rpm																																																																																																																																																																																																																																																																																																																																																																																																																												
158	寄存器	jogging_velicity24	24号轴点动速度	10	10	10	1	100	rpm																																																																																																																																																																																																																																																																																																																																																																																																																												
160	寄存器	jogging_velicity25	25号轴点动速度	10	10	10	1	100	rpm																																																																																																																																																																																																																																																																																																																																																																																																																												
162	寄存器	jogging_velicity26	26号轴点动速度	10	10	10	1	100	rpm																																																																																																																																																																																																																																																																																																																																																																																																																												
164	寄存器	jogging_velicity27	27号轴点动速度	10	10	10	1	100	rpm																																																																																																																																																																																																																																																																																																																																																																																																																												
166	寄存器	jogging_velicity28	28号轴点动速度	10	10	10	1	100	rpm																																																																																																																																																																																																																																																																																																																																																																																																																												
168	寄存器	jogging_velicity29	29号轴点动速度	10	10	10	1	100	rpm																																																																																																																																																																																																																																																																																																																																																																																																																												
170	寄存器	jogging_velicity30	30号轴点动速度	10	10	10	1	100	rpm																																																																																																																																																																																																																																																																																																																																																																																																																												
172	寄存器	jogging_velicity31	31号轴点动速度	10	10	10	1	100	rpm																																																																																																																																																																																																																																																																																																																																																																																																																												
174	寄存器	jogging_velicity32	32号轴点动速度	10	10	10	1	100	rpm																																																																																																																																																																																																																																																																																																																																																																																																																												
176	寄存器	jogging_velicity33	33号轴点动速度	10	10	10	1	100	rpm																																																																																																																																																																																																																																																																																																																																																																																																																												
178	寄存器	jogging_velicity34	34号轴点动速度	10	10	10	1	100	rpm																																																																																																																																																																																																																																																																																																																																																																																																																												
180	寄存器	jogging_velicity35	35号轴点动速度	10	10	10	1	100	rpm																																																																																																																																																																																																																																																																																																																																																																																																																												
182	寄存器	jogging_velicity36	36号轴点动速度	10	10	10	1	100	rpm																																																																																																																																																																																																																																																																																																																																																																																																																												
184	寄存器	jogging_velicity37	37号轴点动速度	10	10	10	1	100	rpm																																																																																																																																																																																																																																																																																																																																																																																																																												
186	寄存器	jogging_velicity38	38号轴点动速度	10	10	10	1	100	rpm																																																																																																																																																																																																																																																																																																																																																																																																																												
188	寄存器	jogging_velicity39	39号轴点动速度	10	10	10	1	100	rpm																																																																																																																																																																																																																																																																																																																																																																																																																												
190	寄存器	jogging_velicity40	40号轴点动速度	10	10	10	1	100	rpm																																																																																																																																																																																																																																																																																																																																																																																																																												
<p>2、ModePos = 7 使设备模式切换到点动模式。</p>	<pre> %DB1 "MD_PN_CTRL_DB" %FB1 "MD_PN_CTRL" EN ModePos 7 EnableAxis TRUE CancelTraversing TRUE IntermediateStop TRUE Positive false Negative false Jog1 4 Jog2 5 AckError false ExecuteMode false Position 0 Velocity 0 OverV 100 OverAcc 100 TransferType 0 AxisEnabled false AxisPosOk false AxisRef false AxisWarn false AxisAlarm false AxisError false Lockout false ActVelocity 0 ActPosition 0 ActMode 0 ActWarn 16#0 ActAlarm 16#0 ActFault 16#0 Error 0 Status 16#0 </pre>																																																																																																																																																																																																																																																																																																																																																																																																																																				
<p>3、EnableAxis = TRUE 使能电机。</p>																																																																																																																																																																																																																																																																																																																																																																																																																																					
<p>4、Jog1 = 1 信号为 1 时，设备以 60rpm 的速度向正方向旋转。</p>																																																																																																																																																																																																																																																																																																																																																																																																																																					
<p>5、Jog1 = 0 复位正转信号，设备停止正转。</p>																																																																																																																																																																																																																																																																																																																																																																																																																																					

8.1.5.3.3.3.8 寸动模式

寸动模式	
步骤	图示
<p>1、参数 jog_velocity = 60 设置点动速度为 60rpm。(寸动速度=点动速度)</p>	
<p>2、参数 jog_increase_distance = -2 设置寸动距离为-2，即 2 的-2 次方，为 0.25 圈。</p>	
<p>3、ModePos = 8 使设备模式切换到寸动模式。</p>	
<p>4、EnableAxis = TRUE 使能电机。</p>	
<p>5、Jog1 = 1 该信号上升沿时启动任务,设备往正方向旋转 0.25 圈。</p>	

8.1.5.4 报文 111 使用方法

报文 111 (Telegram 111) 是 PROFIdrive 协议定义的一种扩展型过程数据报文, 适用于需要传输更多控制与状态信息的应用场景。在 TIA Portal (博途) 中, 推荐使用 SINAPOS 功能块对其进行配置与控制。

具体操作因博途版本略有差异:

TIA 博途版本	使用建议
V15 / V15.1	安装 Startdrive 后, 可使用 SINA_POS (FB284) 控制报文 111。
V16 及以上	推荐使用 SINAPOS (FB300), 功能更全面, 可通过选件包 → SINAMICS 调用, 或通过 Startdrive 自动生成。

8.1.5.4.1 SINAPOS

8.1.5.4.1.1 输入接口

SINAPOS 的输入接口			
输入信号	类型	默认值	含义
ModePos	Int	0	运动模式： 1=相对位置模式 2=绝对位置模式 3=速度模式 4=主动回零模式 5=零点设置模式 6=程序步模式(暂未兼容) 7=点动模式 8=寸动模式
EnableAxis	Bool	FALSE	轴使能 0 = 失能, 1 = 使能
CancelTraversing	Bool	TRUE	取消任务： 0=取消当前的运行任务 1=不取消当前的运行任务
IntermediateStop	Bool	TRUE	暂停任务： 0 = 暂停当前运行任务 1 = 不暂停当前运行任务
Positive	Bool	FALSE	正向 1 = 激活正向旋转, 0 = 未激活正向旋转 【速度模式】由 Positive/Negative 决定旋转方向 【主动回零模式】由 Positive/Negative 决定回零旋转方向(暂未兼容) 注意: 当前版本暂不支持通过 Positive/Negative 信号控制方向, 但仍需置位 Positive/Negative 信号才能启动主动回零。实际回零方向以配置软件中的设置为准
Negative	Bool	FALSE	负向 1 = 激活负向旋转, 0 = 未激活负向旋转 【速度模式】由 Positive/Negative 决定旋转方向 【主动回零模式】由 Positive/Negative 决定回零旋转方向(暂未兼容) 注意: 当前版本暂不支持通过 Positive/Negative 信号控制方向, 但仍需置位 Positive/Negative 信号才能启动主动回零。实际回零方向以配置软件中的设置为准
Jog1	Bool	FALSE	JOG- 1 = 激活负向点/寸动, 0 = 未激活负向点/寸动
Jog2	Bool	FALSE	JOG+ 1 = 激活正向点/寸动, 0 = 未激活正向点/寸动
FlyRef	BOOL	FALSE	0 = 主动回参考点 1 = 被动回参考点(需配合 ConfigEPos:BIT6 零点开关信号使用)

AckError	Bool	FALSE	确认错误 1 = 确认错误有效 0 = 确认错误无效	
ExecuteMode	Bool	FALSE	激活运行作业,不能和轴使能在同一个 PLC 扫描周期内进行动作触发	
Position	DInt	0 [lu]	设定位置(lu)	
Velocity	DInt	0 [1000lu/min]	设定速度(1000lu/min)	
OverV	Int	100 [%]	所有运行模式的速度倍率有效: 0-199%	
OverAcc	Int	100 [%]	加速度倍率有效 0-100%, 不适用于主动回零、点动及寸动模式	
OverDec	int	100[%]	预留	
ConfigEPos	DWORD	0x3	位 0	OFF2(1 = 无脉冲禁用)
			位 1	OFF3(1 = 无斜坡停止)
			位 2	激活软限位功能(零点设置后生效)
			位 3	激活硬限位功能(与调试软件中启用硬限位功能互为“或”逻辑, 两者满足其一即生效)
			位 4	预留
			位 5	
			位 6	零点开关信号
			位 7	预留
			位 8	设定值连续传输 (绝对位置模式、速度模式下有效) 0=单步传输 (通过<启动任务>上升沿接收新的设定值) 1=连续传输 (立即接收新的设定值)
			位 9	预留
			位 10	
			位 11	
			位 12	
			位 13	
			位 14	
			位 15	
			位 16	
			位 17	
			位 18	
			位 19	
			位 20	
			位 21	
			位 22	
			位 23	
			位 24	
			位 25	
			位 26	
			位 27	
			位 28	
			位 29	
			位 30	
			位 31	

HWIDSTW	HW_IO	0	<p>设备模块硬件标识符:</p> <p>设备和网络->要控制的设备->属性->系统常数->硬件标识符</p> <p>详见 设备模块硬件标识符</p>
HWIDZSW	HW_IO	0	<p>设备模块硬件标识符:</p> <p>设备和网络->要控制的设备->属性->系统常数->硬件标识符</p> <p>详见 设备模块硬件标识符</p>

8.1.5.4.1.2 输出接口

SINAPOS 的输出接口			
输出信号	类型	默认值	含义
AxisEnabled	Bool	FALSE	驱动已准备就绪,可以接通
AxisPosOk	Bool	FALSE	已到达轴目标位置
AxisSpFixed	Bool	False	轴已静止
AxisRef	Bool	FALSE	原点设置完成 0=零点未设置 1=零点已设置
AxisWarn	Bool	FALSE	轴警告标识 0=无警告 1=有警告
AxisError	Bool	FALSE	轴故障标识 0=无故障 1=有故障
Lockout	Bool	FALSE	禁止接通
ActVelocity	DInt	0	当前速度(标准化值, 40000000h = 100% = 3000 rpm)
ActPosition	DInt	0	当前位置(编码器值, 单位: lu)
ActMode	Int	0	当前激活的运行模式
EPosZSW1	WORD	0	EPosZSW1 状态
EPosZSW2	WORD	0	EPosZSW2 状态
ActWarn	Word	16#0	当前警告字
ActFault	Word	16#0	当前故障字
Error	Bool	FALSE	1=块调用错误
Status	Word	16#0	块状态: 16#7002:无错误 16#8202:运行模式值超程 16#8203:速度/加速度值超程 16#8600:读取数据错误 16#8601:写入数据错误
DiagID	Word	16#0	扩展通讯错误

8.1.5.4.1.3 关联控制对象

必要参数设定																															
步骤	图示																														
<p>1、确认控制对象</p> <p>查看你要控制的设备的硬件标识符。</p> <p>设备模块硬件标识符</p> <p>设备和网络->要控制的设备->属性->系统常数-> Hw_SubModule(XXX~驱动_1~西门子报文_111_PZD-12_12)的值 图示中为 <u>262</u></p>	 <table border="1"> <thead> <tr> <th>名称</th> <th>类型</th> <th>硬件标识符</th> <th>使用者</th> <th>注释</th> </tr> </thead> <tbody> <tr> <td>md-dev~X1~X1_P1</td> <td>Hw_Interface</td> <td>274</td> <td>PLC_1</td> <td></td> </tr> <tr> <td>md-dev~X1</td> <td>Hw_Interface</td> <td>273</td> <td>PLC_1</td> <td></td> </tr> <tr> <td>md-dev~Proxy</td> <td>Hw_SubModule</td> <td>272</td> <td>PLC_1</td> <td></td> </tr> <tr> <td>md-dev~Head</td> <td>Hw_SubModule</td> <td>275</td> <td>PLC_1</td> <td></td> </tr> <tr> <td>md-dev-驱动_1~西门子报文_111_PZD-12_12</td> <td>Hw_SubModule</td> <td>276</td> <td>PLC_1</td> <td></td> </tr> </tbody> </table>	名称	类型	硬件标识符	使用者	注释	md-dev~X1~X1_P1	Hw_Interface	274	PLC_1		md-dev~X1	Hw_Interface	273	PLC_1		md-dev~Proxy	Hw_SubModule	272	PLC_1		md-dev~Head	Hw_SubModule	275	PLC_1		md-dev-驱动_1~西门子报文_111_PZD-12_12	Hw_SubModule	276	PLC_1	
名称	类型	硬件标识符	使用者	注释																											
md-dev~X1~X1_P1	Hw_Interface	274	PLC_1																												
md-dev~X1	Hw_Interface	273	PLC_1																												
md-dev~Proxy	Hw_SubModule	272	PLC_1																												
md-dev~Head	Hw_SubModule	275	PLC_1																												
md-dev-驱动_1~西门子报文_111_PZD-12_12	Hw_SubModule	276	PLC_1																												
<p>2、将硬件标识符填入 HWDSTW、HWDZSW 管脚</p> <p>将 SINAPOS 功能块与指定的受控设备进行数据交互。</p>	 <p>SinaPos</p> <p>EN: 0, ModePos: 0, EnableAxis: 0, CancelTraversing: 1, IntermediateStop: 1, Positive: 0, Negative: 0, Jog1: 0, Jog2: 0, FlyRef: 0, AckError: 0, ExecuteMode: 0, Position: 0, Velocity: 0, OverV: 100, OverAcc: 100, OverDec: 100, ConfigEPos: 16#0000_0003, 262, "md-入料~Module_1~Telegram_111": 262, "md-入料~Module_1~Telegram_111": 262</p> <p>ENO: AxisEnabled: 0, AxisPosOk: 0, AxisSpFixed: 0, AxisRef: 0, AxisWarn: 0, AxisError: 0, Lockout: 0, ActVelocity: 0, ActPosition: 0, ActMode: 0, EPosZSW1: 0, EPosZSW2: 0, ActWarn: 0, ActFault: 0, Error: 0, Status: 0, DiagId: 0</p>																														

8.2 西门子 S7-1200 样例(MODBUS-TCP)

8.2.1 涉及软硬件

- 硬件：
- 1、S7-1200 CPU1212C AC/DC/RLY
 - 2、百川 MD 系列 Modbus TCP 一体式步进伺服
 - 3、计算机
 - 4、网线
 - 5、交换机

软件： 1、TIA Portal V18 2、BCZY DTools

外部源文件：MD_MBTCP.scl 、 MD_MBTCP_CTRL.scl

8.2.2 硬件连接

8.2.2.1 建立连接

本一体式步进伺服采用 DC 24V ($\pm 15\%$) 输入，本样例将使用 AC100-240V 转 DC24V 作为输入电源。

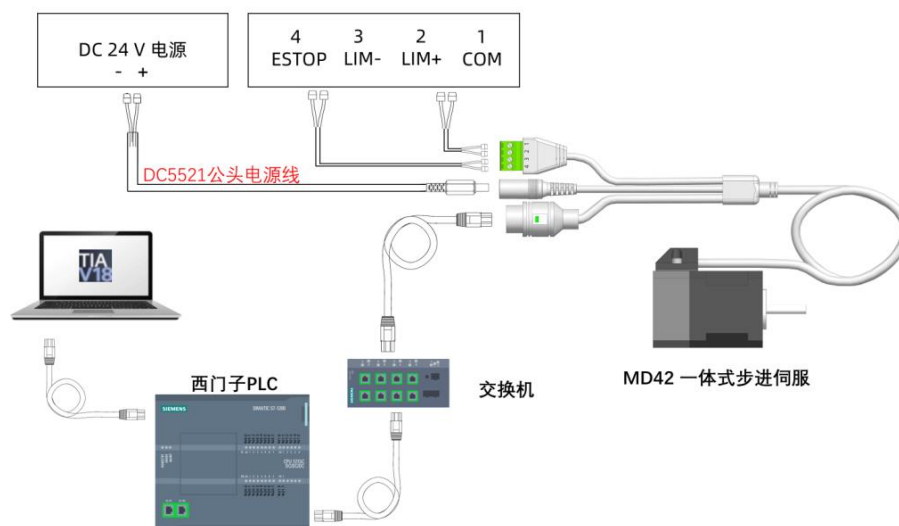

使用 DC5521 公头电源线将 DC24V 接入一体式步进伺服 DC5521 母头。

通过标准 RJ45 网线将调试计算机、PLC、一体式步进伺服连接到交换机组网。

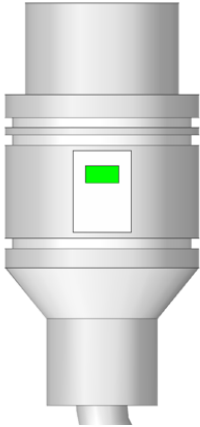

8.2.2.2 检查系统指示灯

电源通电后，未完成组态时，状态如下表状态 2 间隔短闪。

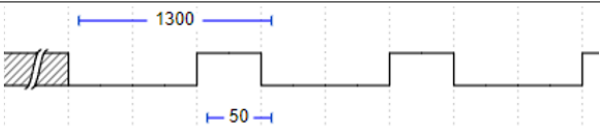
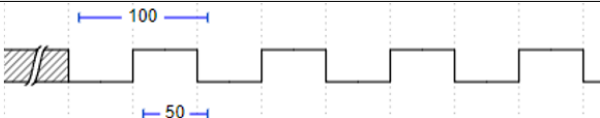
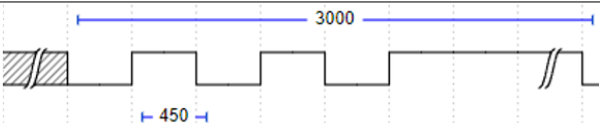
LED灯	状态	LED闪烁波形(单位:ms)
	1、常亮。控制器已连接通信正常	
	2、间隔短闪。无控制器连接	
	3、快闪。设备初始化	
	4、周期闪烁三次后恢复1/2/3状态。查找设备功能	

8.2.3 控制电机

8.2.3.1 控制方法

本样例提供 SCL 文件，方便用户使用。

1、MD_MBTCP_CTRL.scl: 可通过引脚直接控制电机运行。

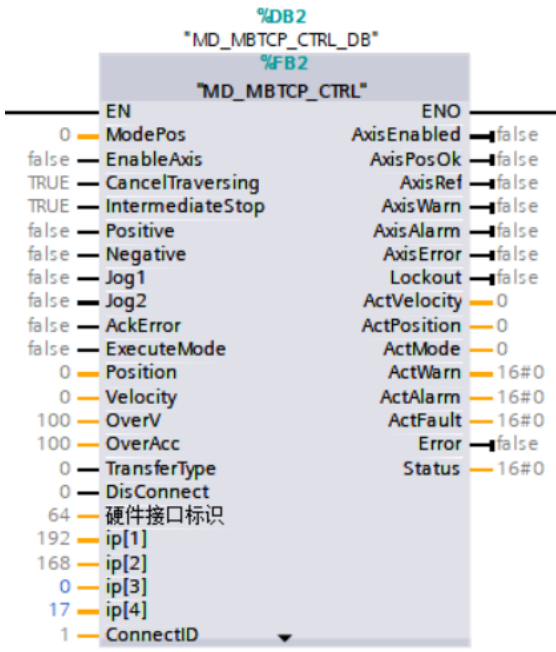
外部源文件名称	引脚																																																																																																
MD_MBTCP_CTRL.scl	 <p>The diagram shows the pinout for the MD_MBTCP_CTRL component. It is connected to a database (%DB2) and a function block (%FB2). The component name is MD_MBTCP_CTRL. The inputs and outputs are as follows:</p> <table border="1"> <thead> <tr> <th>Input</th> <th>Value</th> <th>Output</th> <th>Value</th> </tr> </thead> <tbody> <tr> <td>EN</td> <td>0</td> <td>ENO</td> <td></td> </tr> <tr> <td>ModePos</td> <td>false</td> <td>AxisEnabled</td> <td>false</td> </tr> <tr> <td>EnableAxis</td> <td>false</td> <td>AxisPosOk</td> <td>false</td> </tr> <tr> <td>CancelTraversing</td> <td>TRUE</td> <td>AxisRef</td> <td>false</td> </tr> <tr> <td>IntermediateStop</td> <td>TRUE</td> <td>AxisWarn</td> <td>false</td> </tr> <tr> <td>Positive</td> <td>false</td> <td>AxisAlarm</td> <td>false</td> </tr> <tr> <td>Negative</td> <td>false</td> <td>AxisError</td> <td>false</td> </tr> <tr> <td>Jog1</td> <td>false</td> <td>Lockout</td> <td>false</td> </tr> <tr> <td>Jog2</td> <td>false</td> <td>ActVelocity</td> <td>0</td> </tr> <tr> <td>AckError</td> <td>false</td> <td>ActPosition</td> <td>0</td> </tr> <tr> <td>ExecuteMode</td> <td>false</td> <td>ActMode</td> <td>0</td> </tr> <tr> <td>Position</td> <td>0</td> <td>ActWarn</td> <td>16#0</td> </tr> <tr> <td>Velocity</td> <td>0</td> <td>ActAlarm</td> <td>16#0</td> </tr> <tr> <td>OverV</td> <td>100</td> <td>ActFault</td> <td>16#0</td> </tr> <tr> <td>OverAcc</td> <td>100</td> <td>Error</td> <td>false</td> </tr> <tr> <td>TransferType</td> <td>0</td> <td>Status</td> <td>16#0</td> </tr> <tr> <td>DisConnect</td> <td>0</td> <td></td> <td></td> </tr> <tr> <td>硬件接口标识</td> <td>64</td> <td></td> <td></td> </tr> <tr> <td>ip[1]</td> <td>192</td> <td></td> <td></td> </tr> <tr> <td>ip[2]</td> <td>168</td> <td></td> <td></td> </tr> <tr> <td>ip[3]</td> <td>0</td> <td></td> <td></td> </tr> <tr> <td>ip[4]</td> <td>17</td> <td></td> <td></td> </tr> <tr> <td>ConnectID</td> <td>1</td> <td></td> <td></td> </tr> </tbody> </table>	Input	Value	Output	Value	EN	0	ENO		ModePos	false	AxisEnabled	false	EnableAxis	false	AxisPosOk	false	CancelTraversing	TRUE	AxisRef	false	IntermediateStop	TRUE	AxisWarn	false	Positive	false	AxisAlarm	false	Negative	false	AxisError	false	Jog1	false	Lockout	false	Jog2	false	ActVelocity	0	AckError	false	ActPosition	0	ExecuteMode	false	ActMode	0	Position	0	ActWarn	16#0	Velocity	0	ActAlarm	16#0	OverV	100	ActFault	16#0	OverAcc	100	Error	false	TransferType	0	Status	16#0	DisConnect	0			硬件接口标识	64			ip[1]	192			ip[2]	168			ip[3]	0			ip[4]	17			ConnectID	1		
Input	Value	Output	Value																																																																																														
EN	0	ENO																																																																																															
ModePos	false	AxisEnabled	false																																																																																														
EnableAxis	false	AxisPosOk	false																																																																																														
CancelTraversing	TRUE	AxisRef	false																																																																																														
IntermediateStop	TRUE	AxisWarn	false																																																																																														
Positive	false	AxisAlarm	false																																																																																														
Negative	false	AxisError	false																																																																																														
Jog1	false	Lockout	false																																																																																														
Jog2	false	ActVelocity	0																																																																																														
AckError	false	ActPosition	0																																																																																														
ExecuteMode	false	ActMode	0																																																																																														
Position	0	ActWarn	16#0																																																																																														
Velocity	0	ActAlarm	16#0																																																																																														
OverV	100	ActFault	16#0																																																																																														
OverAcc	100	Error	false																																																																																														
TransferType	0	Status	16#0																																																																																														
DisConnect	0																																																																																																
硬件接口标识	64																																																																																																
ip[1]	192																																																																																																
ip[2]	168																																																																																																
ip[3]	0																																																																																																
ip[4]	17																																																																																																
ConnectID	1																																																																																																

8.2.3.2 查看信息

8.2.3.2.1 硬件设备标识符

右键 PLC -> 属性 -> 系统常数 -> Local~PROFINET_接口_1 (Hw_Interface)

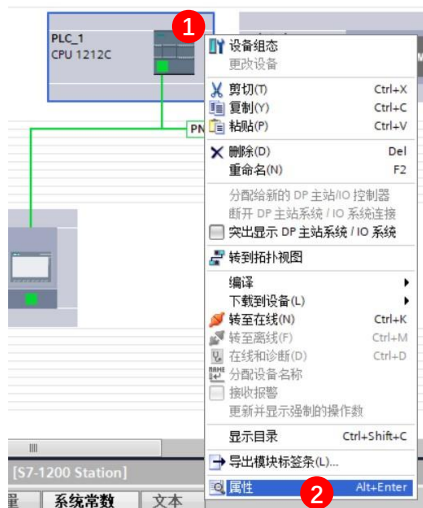

The screenshot shows the SIMATIC Manager '系统常数' (System Constants) window. The window title is 'PLC_1 [CPU 1212C AC/DC/RV]'. The '属性' (Properties) tab is selected. The '显示硬件系统常数' (Show Hardware System Constants) dropdown is set to '显示硬件系统常数'. The table below shows the hardware system constants for the PLC_1 station.

名称	类型	硬件标识符	使用者
Local-MC	Hw_SubModule	51	PLC_1
Local-Common	Hw_SubModule	50	PLC_1
Local-Device	Hw_Device	32	PLC_1
Local-Configuration	Hw_SubModule	33	PLC_1
Local-Exec	Hw_SubModule	52	PLC_1
Local	Hw_SubModule	49	PLC_1
Local-PROFINET_接口_1	Hw_Interface	64	PLC_1
Local-HSC_1	Hw_Hsc	257	PLC_1
Local-HSC_2	Hw_Hsc	258	PLC_1
Local-HSC_3	Hw_Hsc	259	PLC_1
Local-HSC_4	Hw_Hsc	260	PLC_1
Local-HSC_5	Hw_Hsc	261	PLC_1
Local-HSC_6	Hw_Hsc	262	PLC_1
Local-AI_2_1	Hw_SubModule	263	PLC_1
Local-DI_8_DQ_6_1	Hw_SubModule	264	PLC_1
Local-OPC-UA	Hw_SubModule	117	PLC_1
Local-Pulse_1	Hw_Pwm	265	PLC_1
Local-Pulse_2	Hw_Pwm	266	PLC_1

8.2.3.3源文件使用方法

8.2.3.3.1 导入源文件

外部源文件 -> 添加新的外部文件 -> XXXX.scl -> 打开

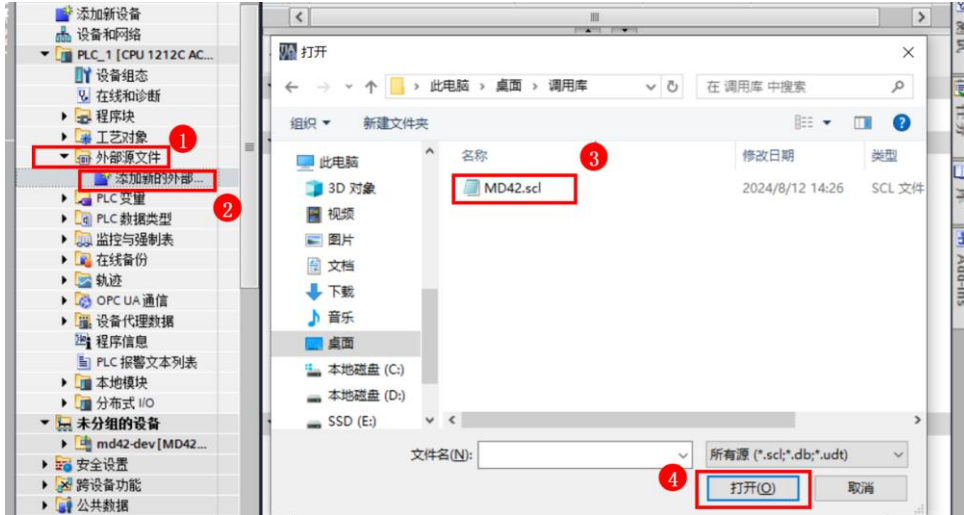

处于在线模式下时 应该先转至离线 -> 右键 XXXX.scl -> 从源生成块

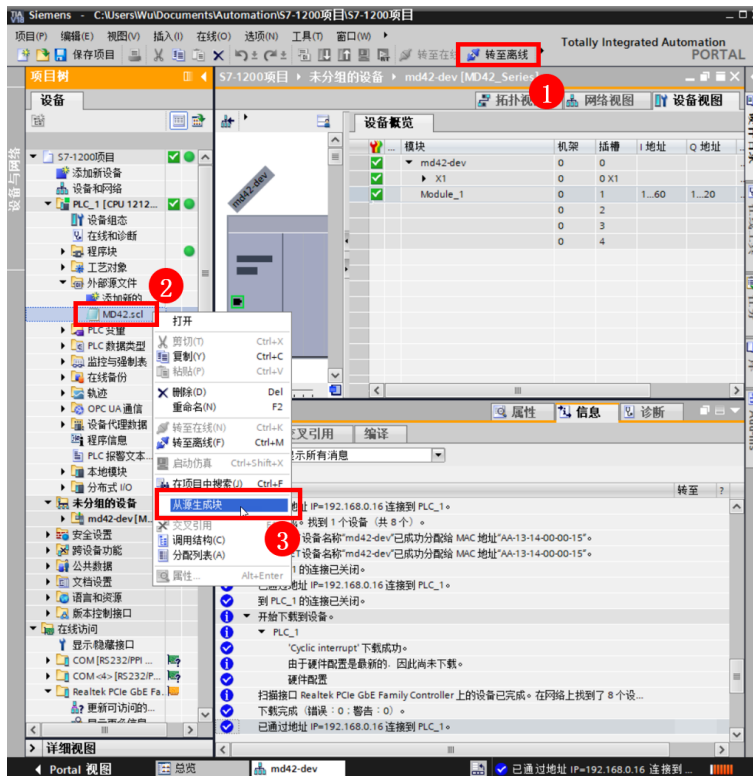

8.2.3.3.2 调用生成块

将生成的块拖入程序段中

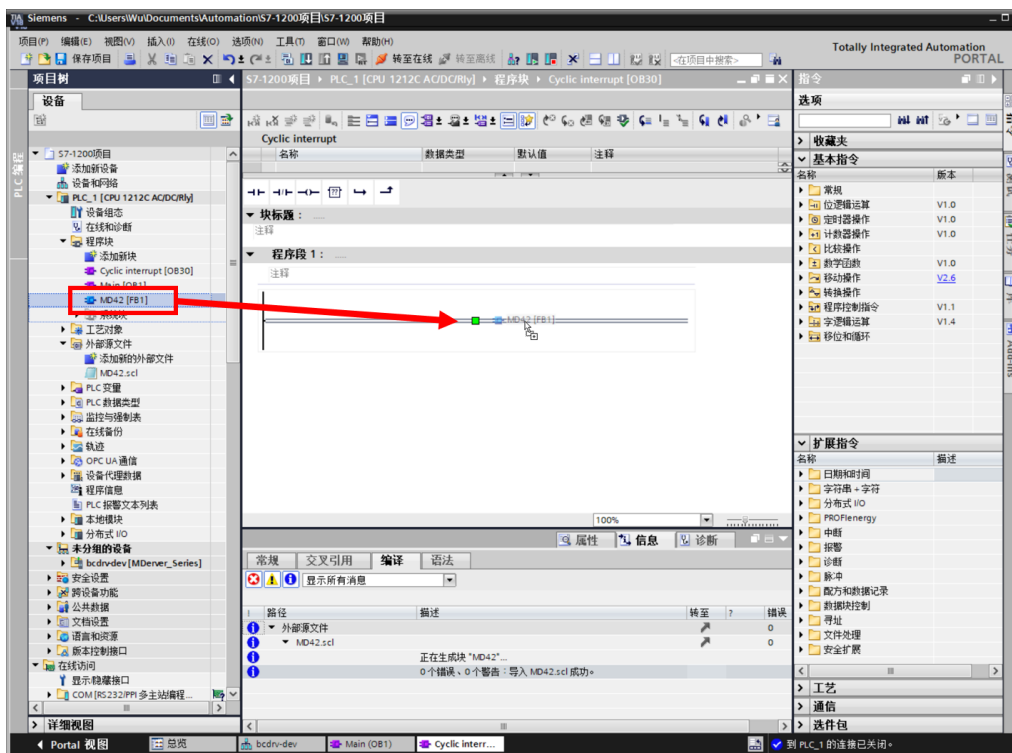

可修改名称 -> 确定



8.2.3.4 MD_MBTCP_CTRL.scl

MD_MBTCP_CTRL.scl 文件所生成的块如下：

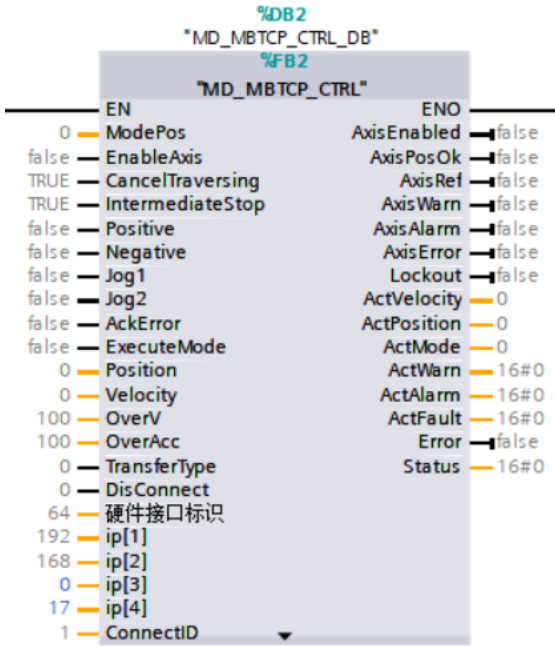

在指定设备模块的硬件标识符后，可通过对函数块输入输出硬件操作，实现对电机的控制。

硬件接口标识填写调用该块的 **PLC 接口标识符**

查看方法可见：[硬件设备标识符](#)

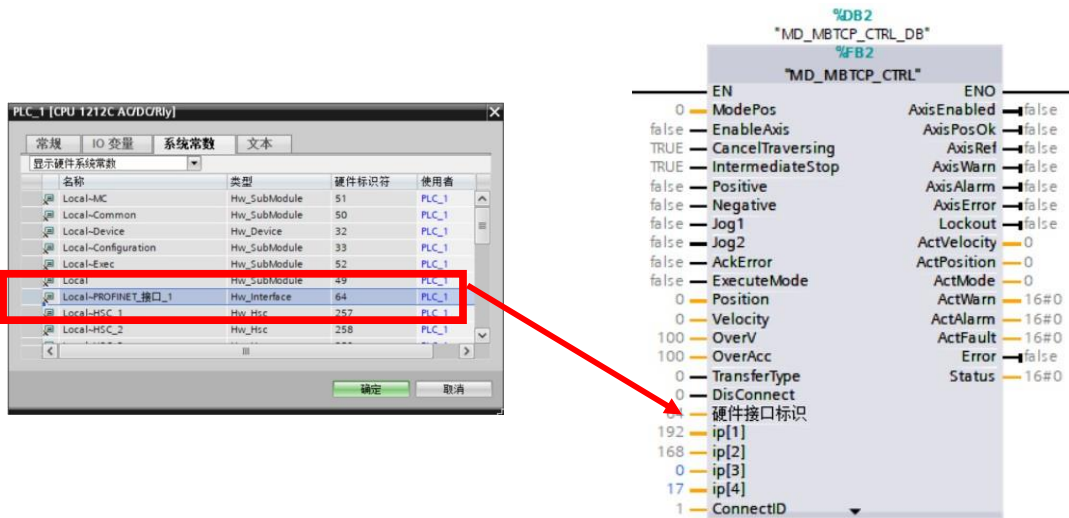

单个 PLC 控制多台设备时

需要有不同的背景数据块, IP 地址不能冲突、ConnectID 不能冲突

1、不同的背景数据块



8.2.3.4.1 块接口说明

8.2.3.4.1.1 输入接口

MD_MBTCP_CTRL 的输入接口			
输入信号	类型	默认值	含义
ModePos	Int	0	运动模式: 0=电机失能 1=相对位置模式 2=绝对位置模式 3=速度模式 4=主动回零模式 5=零点设置模式 6=程序步模式 7=点动模式 8=寸动模式
EnableAxis	Bool	FALSE	轴使能
CancelTraversing	Bool	TRUE	取消任务: 0=取消当前的运行任务 1=不取消当前的运行任务
IntermediateStop	Bool	TRUE	暂停任务: 0 = 暂停当前运行任务 1 = 不暂停当前运行任务
Positive	Bool	FALSE	正向 (1 = 激活正向旋转, 0 = 未激活正向旋转) 仅速度模式有效
Negative	Bool	FALSE	负向 (1 = 激活负向旋转, 0 = 未激活负向旋转) 仅速度模式有效
Jog1	Bool	FALSE	JOG+(1 = 激活正向点/寸动, 0 = 未激活正向点/寸动)
Jog2	Bool	FALSE	JOG-(1 = 激活负向点/寸动, 0 = 未激活负向点/寸动)
AckError	Bool	FALSE	确认错误(1 = 确认错误有效, 0 = 确认错误无效)
ExecuteMode	Bool	FALSE	激活运行作业, 不要和轴使能在同一个 PLC 扫描周期内进行动作触发
Position	DInt	0 [lu]	设定位置(lu)
Velocity	DInt	0 [lu/s]	设定速度(lu/s)
OverV	Int	100 [%]	所有运行模式的速度倍率有效: 0-199%
OverAcc	Int	100 [%]	加速度倍率有效 0-100%, 不适用于主动回零、点动及寸动模式
TransferType	Bool	0	传输方式: 0=单步传输 (通过<ExecuteMode>上升沿接收新的设定值) 1=连续传输 (立即接收新的设定值)
DisConnect	Bool	0	取消连接: 0=根据参数连接 ModBusTCP 服务器 1=断开与 ModBusTCP 服务器的连接
硬件接口标识	HW_INTERFAC E	64	硬件接口标识符: PLC 接口组件的标识, 应填写调用该块的 PLC 的硬件标识。PLC->属性->系统常数->Hw_Interface(Local~PROFINET_接口_1)的值
ip[1]	USInt	192	ip[1]: IP 地址第一个字节
ip[2]	USInt	168	ip[2]: IP 地址第二个字节
ip[3]	USInt	200	ip[3]: IP 地址第三个字节
ip[4]	USInt	244	ip[4]: IP 地址第四个字节
ConnectID	CONN_OUC	1	开放式通信的连接 ID, 范围为 1 - 4095, 同一 PLC 中, ID 不冲突的情况下可以任意使用。

8.2.3.4.1.2 输出接口

MD_MBTCP_CTRL 的输出接口			
输出信号	类型	默认值	含义
AxisEnabled	Bool	FALSE	轴已经使能
AxisPosOk	Bool	FALSE	已到达轴目标位置(斜坡位置与实际位置同时到达)
AxisRef	Bool	FALSE	原点设置完成 0=零点未设置 1=零点已设置
AxisWarn	Bool	FALSE	轴警告标识 0=无警告 1=有警告
not_homed	Bool	FALSE	警告: 未回零点(零点未设置)
positive_limit_switch_approached	Bool	FALSE	警告: 到达正限位
negative_limit_switch_approached	Bool	FALSE	警告: 到达负限位
soft_positive_limit_approached	Bool	FALSE	警告: 到达软正限位
soft_negative_limit_approached	Bool	FALSE	警告: 到达软负限位
drv_otpw	Bool	FALSE	警告: 驱动电路高温预警(120°C)
no_calibration	Bool	FALSE	警告: 电机未校准
AxisAlarm	Bool	FALSE	轴报警标识 0=无报警 1=有报警
limit_approached	Bool	FALSE	报警: 到达(软/硬)限位
AxisError	Bool	FALSE	轴故障标识 0=无故障 1=有故障
emergency_stop_activated	Bool	FALSE	故障: 急停已激活
excessive_following_error	Bool	FALSE	故障: 跟随误差过大
stall	Bool	FALSE	故障: 电机发生堵转
error_no_calibration	Bool	FALSE	故障: 电机未校准
drv_over_current	Bool	FALSE	故障: 电机过流
drv_open_circuit	Bool	FALSE	故障: 电机开路
drv_over_temperature	Bool	FALSE	故障: 驱动电路过温(150°C)
Lockout	Bool	FALSE	无
ActVelocity	DInt	0	当前速度(经滤波的编码器值, 单位: lu/s)
ActPosition	DInt	0	当前位置(编码器值, 单位: lu)
ActMode	Int	0	当前模式
ActWarn	Word	16#0	当前警告字
ActAlarm	Word	16#0	当前报警字
ActFault	Word	16#0	当前故障字
Error	Bool	FALSE	1=块调用错误
Status	Word	16#0	块状态: 16#7002:无错误 16#8202:运行模式值超程 16#8203:速度/加速度值超程 16#8204 连接 ID 值超程

8.2.3.4.2 关联控制对象

必要参数设定	
步骤	图示
<p>1、确认 PLC 的硬件接口标识。</p> <p>右键 PLC ->属性->系统常数 ->Local~PROFINET_接口_1 (Hw_Interface)</p> <p>图示中为 64</p> <p>查询步骤可见：硬件设备标识符</p>	
<p>2、输入硬件接口标识符。</p>	
<p>3、输入 IP 地址</p> <p>输入需要控制的设备 IP。</p> <p>设备出厂默认 IP 为：192.168.200.244，可通过设备调试工具 BCZY DTools 查找局域网中的设备。</p>	
<p>4、输入连接 ID</p> <p>在同一 PLC 中，且不冲突的情况下，可在范围 1 - 4095 中任意使用。</p>	

8.2.3.4.3 函数块控制

8.2.3.4.3.1 相对定位模式

相对位置模式	
步骤	图示
1、ModePos = 1 运动模式切换到相对位置模式。	
2、CancelTraversing = TRUE 让设备不暂停任务。	
3、IntermediateStop = TRUE 让设备不取消任务。	
4、Position = 5000 确定相对位置移动的距离，单位为 lu。	
5、Velocity = 5000 确定相对位置移动的速度，单位为 lu/s。	
6、EnableAxis=1 让电机使能。	
7、等待时间 X 确保参数传输完毕，X 建议不小于 30 ms。	
8、ExecuteMode = TRUE 该信号上升沿时启动任务,设备按照设定的位置和速度执行相对位置运动。	

8.2.3.4.3.2 绝对定位模式

绝对位置模式	
步骤	图示
1、检查 AxisRef 等于 TRUE 确认轴已回零。设备绝对位置模式需要零点作为的参考点。	
2、ModePos = 2 运动模式切换到绝对位置模式。	
3、CancelTraversing = TRUE 让设备不暂停任务。	
4、IntermediateStop = TRUE 让设备不取消任务。	
5、Position = 5000 确定绝对位置移动的位置，单位为 lu。	
6、Velocity = 5000 确定绝对位置移动的速度，单位为 lu/s。	
7、EnableAxis=1 让电机使能。	
8、等待时间 X 确保参数传输完毕，X 建议不小于 30 ms。	
9、ExecuteMode = TRUE 该信号上升沿时启动任务,设备按照设定的位置和速度执行绝对位置运动。	

8.2.3.4.3.3 速度模式

速度模式	
步骤	图示
1、ModePos = 3 运动模式切换到速度模式。	
2、CancelTraversing = TRUE 让设备不暂停任务。	
3、IntermediateStop = TRUE 让设备不取消任务。	
4、Velocity = 5000 确定速度模式移动的速度，单位为 lu/s。	
5、Positive = TRUE 确认旋转方向为正方向。	
6、EnableAxis=1 让电机使能。	
7、等待时间 X 确保参数传输完毕，X 建议不小于 30 ms。	
8、ExecuteMode = TRUE 该信号上升沿时启动任务,设备按照设定的速度执行速度模式运动。	

8.2.3.4.3.4 主动回零模式

8.2.3.4.3.4.1 扭矩回零

主动回零模式-使用扭矩回零方式	
步骤	图示
1、参数 limit_protect_enable = 0 关闭硬限位功能。	
2、参数 homing_method = 0 使用扭矩回零。	
3、参数 homing_use_z_signal = 0 关闭 z 信号辅助回零。	
4、参数 homing_torque_threshold = 98 扭矩回零阈值设置为 98%。	
5、ModePos = 4 运动模式切换到主动回零模式。	
6、CancelTraversing = TRUE 让设备不暂停任务。	
7、IntermediateStop = TRUE 让设备不取消任务。	
8、EnableAxis=1 让电机使能。	
9、等待时间 X 确保参数传输完毕, X 建议不小于 30 ms。	
10、ExecuteMode = TRUE 该信号上升沿时启动任务,设备按照参数表设定的回零参数执行主动回零。	

8.2.3.4.3.4.2 扭矩回零+编码器 z 信号

主动回零模式-使用扭矩回零方式+编码器 z 信号																																																																																																																																																																																																																																																																																																																																																																																											
步骤	图示																																																																																																																																																																																																																																																																																																																																																																																										
1、参数 limit_protect_enable = 0 关闭硬限位功能。	<table border="1"> <thead> <tr> <th>参数号</th> <th>参数名</th> <th>参数值</th> <th>描述</th> <th>出厂值</th> <th>出厂组</th> <th>最小值</th> <th>最大值</th> <th>单位</th> </tr> </thead> <tbody> <tr><td>62</td><td>限位参数</td><td>limit_protect_enable</td><td>位置禁止功能</td><td>10</td><td>10</td><td>10</td><td>10</td><td>ms</td></tr> <tr><td>64</td><td>限位参数</td><td>limit_protect_time</td><td>位置禁止保持时间</td><td>10</td><td>10</td><td>10</td><td>10</td><td>ms</td></tr> <tr><td>66</td><td>限位参数</td><td>velocity_protect_enable</td><td>速度禁止功能</td><td>10</td><td>10</td><td>10</td><td>10</td><td>rpm</td></tr> <tr><td>68</td><td>限位参数</td><td>velocity_protect_time</td><td>速度禁止保持时间</td><td>10</td><td>10</td><td>10</td><td>10</td><td>ms</td></tr> <tr><td>70</td><td>限位参数</td><td>acceleration_protect</td><td>加速度禁止</td><td>2</td><td>2</td><td>2</td><td>2</td><td>rpm</td></tr> <tr><td>72</td><td>限位参数</td><td>acceleration_time</td><td>加速度禁止保持时间</td><td>10</td><td>10</td><td>10</td><td>10</td><td>ms</td></tr> <tr><td>74</td><td>保护功能参数</td><td>following_error_enable_homing</td><td>跟踪误差使能</td><td>0</td><td>0</td><td>0</td><td>0</td><td>%</td></tr> <tr><td>76</td><td>保护功能参数</td><td>following_error_time_homing</td><td>跟踪误差保持时间</td><td>4</td><td>4</td><td>4</td><td>16</td><td>ms</td></tr> <tr><td>78</td><td>保护功能参数</td><td>following_error_time_homing</td><td>跟踪误差保持时间</td><td>4</td><td>4</td><td>4</td><td>16</td><td>ms</td></tr> <tr><td>80</td><td>保护功能参数</td><td>following_error_time_homing</td><td>跟踪误差保持时间</td><td>200</td><td>200</td><td>200</td><td>1</td><td>ms</td></tr> <tr><td>82</td><td>保护功能参数</td><td>max_position_protect</td><td>最大位置保护</td><td>0</td><td>0</td><td>0</td><td>0</td><td>%</td></tr> <tr><td>84</td><td>保护功能参数</td><td>max_position_protect_time</td><td>最大位置保护保持时间</td><td>2</td><td>2</td><td>2</td><td>1</td><td>ms</td></tr> <tr><td>86</td><td>保护功能参数</td><td>max_velocity_protect</td><td>最大速度保护</td><td>100</td><td>100</td><td>100</td><td>1</td><td>%</td></tr> <tr><td>88</td><td>保护功能参数</td><td>max_velocity_protect_time</td><td>最大速度保护保持时间</td><td>200</td><td>200</td><td>200</td><td>1</td><td>ms</td></tr> <tr><td>90</td><td>保护功能参数</td><td>max_acceleration_protect</td><td>最大加速度保护</td><td>0</td><td>0</td><td>0</td><td>0</td><td>%</td></tr> <tr><td>92</td><td>保护功能参数</td><td>max_acceleration_protect_time</td><td>最大加速度保护保持时间</td><td>0</td><td>0</td><td>0</td><td>0</td><td>ms</td></tr> <tr><td>94</td><td>保护功能参数</td><td>max_torque_protect</td><td>最大扭矩保护</td><td>0</td><td>0</td><td>0</td><td>0</td><td>%</td></tr> <tr><td>96</td><td>保护功能参数</td><td>max_torque_protect_time</td><td>最大扭矩保护保持时间</td><td>0</td><td>0</td><td>0</td><td>0</td><td>ms</td></tr> <tr><td>98</td><td>保护功能参数</td><td>max_force_protect</td><td>最大力保护</td><td>0</td><td>0</td><td>0</td><td>0</td><td>%</td></tr> <tr><td>100</td><td>保护功能参数</td><td>max_force_protect_time</td><td>最大力保护保持时间</td><td>0</td><td>0</td><td>0</td><td>0</td><td>ms</td></tr> <tr><td>102</td><td>保护功能参数</td><td>emergency_stop_enable</td><td>急停使能</td><td>0</td><td>0</td><td>0</td><td>0</td><td>%</td></tr> <tr><td>104</td><td>保护功能参数</td><td>emergency_stop_time</td><td>急停保持时间</td><td>0</td><td>0</td><td>0</td><td>0</td><td>ms</td></tr> <tr><td>106</td><td>回零参数</td><td>homing_method</td><td>回零方法</td><td>0</td><td>0</td><td>0</td><td>0</td><td>%</td></tr> <tr><td>108</td><td>回零参数</td><td>homing_force</td><td>回零力</td><td>0</td><td>0</td><td>0</td><td>0</td><td>%</td></tr> <tr><td>110</td><td>回零参数</td><td>homing_time</td><td>回零时间</td><td>0</td><td>0</td><td>0</td><td>0</td><td>ms</td></tr> <tr><td>112</td><td>回零参数</td><td>homing_velocity</td><td>回零速度</td><td>0</td><td>0</td><td>0</td><td>0</td><td>rpm</td></tr> <tr><td>114</td><td>回零参数</td><td>homing_acceleration</td><td>回零加速度</td><td>0</td><td>0</td><td>0</td><td>0</td><td>rpm</td></tr> <tr><td>116</td><td>回零参数</td><td>homing_force_threshold</td><td>回零力阈值</td><td>100</td><td>100</td><td>100</td><td>1</td><td>%</td></tr> <tr><td>118</td><td>回零参数</td><td>homing_force_threshold_time</td><td>回零力阈值保持时间</td><td>10</td><td>10</td><td>10</td><td>1</td><td>ms</td></tr> <tr><td>120</td><td>回零参数</td><td>homing_z_signal</td><td>回零 z 信号</td><td>0</td><td>0</td><td>0</td><td>0</td><td>%</td></tr> <tr><td>122</td><td>回零参数</td><td>homing_z_signal_time</td><td>回零 z 信号保持时间</td><td>0</td><td>0</td><td>0</td><td>0</td><td>ms</td></tr> <tr><td>124</td><td>回零参数</td><td>homing_z_signal_force</td><td>回零 z 信号力</td><td>0</td><td>0</td><td>0</td><td>0</td><td>%</td></tr> <tr><td>126</td><td>回零参数</td><td>homing_z_signal_force_time</td><td>回零 z 信号力保持时间</td><td>0</td><td>0</td><td>0</td><td>0</td><td>ms</td></tr> <tr><td>128</td><td>回零参数</td><td>homing_z_signal_force_threshold</td><td>回零 z 信号力阈值</td><td>0</td><td>0</td><td>0</td><td>0</td><td>%</td></tr> <tr><td>130</td><td>回零参数</td><td>homing_z_signal_force_threshold_time</td><td>回零 z 信号力阈值保持时间</td><td>0</td><td>0</td><td>0</td><td>0</td><td>ms</td></tr> <tr><td>132</td><td>回零参数</td><td>homing_z_signal_force_threshold_force</td><td>回零 z 信号力阈值力</td><td>0</td><td>0</td><td>0</td><td>0</td><td>%</td></tr> <tr><td>134</td><td>回零参数</td><td>homing_z_signal_force_threshold_force_time</td><td>回零 z 信号力阈值力保持时间</td><td>0</td><td>0</td><td>0</td><td>0</td><td>ms</td></tr> <tr><td>136</td><td>回零参数</td><td>homing_z_signal_force_threshold_force_threshold</td><td>回零 z 信号力阈值力阈值</td><td>0</td><td>0</td><td>0</td><td>0</td><td>%</td></tr> <tr><td>138</td><td>回零参数</td><td>homing_z_signal_force_threshold_force_threshold_time</td><td>回零 z 信号力阈值力阈值保持时间</td><td>0</td><td>0</td><td>0</td><td>0</td><td>ms</td></tr> <tr><td>140</td><td>回零参数</td><td>homing_z_signal_force_threshold_force_threshold_force</td><td>回零 z 信号力阈值力阈值力</td><td>0</td><td>0</td><td>0</td><td>0</td><td>%</td></tr> <tr><td>142</td><td>回零参数</td><td>homing_z_signal_force_threshold_force_threshold_force_time</td><td>回零 z 信号力阈值力阈值力保持时间</td><td>0</td><td>0</td><td>0</td><td>0</td><td>ms</td></tr> </tbody> </table>	参数号	参数名	参数值	描述	出厂值	出厂组	最小值	最大值	单位	62	限位参数	limit_protect_enable	位置禁止功能	10	10	10	10	ms	64	限位参数	limit_protect_time	位置禁止保持时间	10	10	10	10	ms	66	限位参数	velocity_protect_enable	速度禁止功能	10	10	10	10	rpm	68	限位参数	velocity_protect_time	速度禁止保持时间	10	10	10	10	ms	70	限位参数	acceleration_protect	加速度禁止	2	2	2	2	rpm	72	限位参数	acceleration_time	加速度禁止保持时间	10	10	10	10	ms	74	保护功能参数	following_error_enable_homing	跟踪误差使能	0	0	0	0	%	76	保护功能参数	following_error_time_homing	跟踪误差保持时间	4	4	4	16	ms	78	保护功能参数	following_error_time_homing	跟踪误差保持时间	4	4	4	16	ms	80	保护功能参数	following_error_time_homing	跟踪误差保持时间	200	200	200	1	ms	82	保护功能参数	max_position_protect	最大位置保护	0	0	0	0	%	84	保护功能参数	max_position_protect_time	最大位置保护保持时间	2	2	2	1	ms	86	保护功能参数	max_velocity_protect	最大速度保护	100	100	100	1	%	88	保护功能参数	max_velocity_protect_time	最大速度保护保持时间	200	200	200	1	ms	90	保护功能参数	max_acceleration_protect	最大加速度保护	0	0	0	0	%	92	保护功能参数	max_acceleration_protect_time	最大加速度保护保持时间	0	0	0	0	ms	94	保护功能参数	max_torque_protect	最大扭矩保护	0	0	0	0	%	96	保护功能参数	max_torque_protect_time	最大扭矩保护保持时间	0	0	0	0	ms	98	保护功能参数	max_force_protect	最大力保护	0	0	0	0	%	100	保护功能参数	max_force_protect_time	最大力保护保持时间	0	0	0	0	ms	102	保护功能参数	emergency_stop_enable	急停使能	0	0	0	0	%	104	保护功能参数	emergency_stop_time	急停保持时间	0	0	0	0	ms	106	回零参数	homing_method	回零方法	0	0	0	0	%	108	回零参数	homing_force	回零力	0	0	0	0	%	110	回零参数	homing_time	回零时间	0	0	0	0	ms	112	回零参数	homing_velocity	回零速度	0	0	0	0	rpm	114	回零参数	homing_acceleration	回零加速度	0	0	0	0	rpm	116	回零参数	homing_force_threshold	回零力阈值	100	100	100	1	%	118	回零参数	homing_force_threshold_time	回零力阈值保持时间	10	10	10	1	ms	120	回零参数	homing_z_signal	回零 z 信号	0	0	0	0	%	122	回零参数	homing_z_signal_time	回零 z 信号保持时间	0	0	0	0	ms	124	回零参数	homing_z_signal_force	回零 z 信号力	0	0	0	0	%	126	回零参数	homing_z_signal_force_time	回零 z 信号力保持时间	0	0	0	0	ms	128	回零参数	homing_z_signal_force_threshold	回零 z 信号力阈值	0	0	0	0	%	130	回零参数	homing_z_signal_force_threshold_time	回零 z 信号力阈值保持时间	0	0	0	0	ms	132	回零参数	homing_z_signal_force_threshold_force	回零 z 信号力阈值力	0	0	0	0	%	134	回零参数	homing_z_signal_force_threshold_force_time	回零 z 信号力阈值力保持时间	0	0	0	0	ms	136	回零参数	homing_z_signal_force_threshold_force_threshold	回零 z 信号力阈值力阈值	0	0	0	0	%	138	回零参数	homing_z_signal_force_threshold_force_threshold_time	回零 z 信号力阈值力阈值保持时间	0	0	0	0	ms	140	回零参数	homing_z_signal_force_threshold_force_threshold_force	回零 z 信号力阈值力阈值力	0	0	0	0	%	142	回零参数	homing_z_signal_force_threshold_force_threshold_force_time	回零 z 信号力阈值力阈值力保持时间	0	0	0	0	ms
参数号	参数名	参数值	描述	出厂值	出厂组	最小值	最大值	单位																																																																																																																																																																																																																																																																																																																																																																																			
62	限位参数	limit_protect_enable	位置禁止功能	10	10	10	10	ms																																																																																																																																																																																																																																																																																																																																																																																			
64	限位参数	limit_protect_time	位置禁止保持时间	10	10	10	10	ms																																																																																																																																																																																																																																																																																																																																																																																			
66	限位参数	velocity_protect_enable	速度禁止功能	10	10	10	10	rpm																																																																																																																																																																																																																																																																																																																																																																																			
68	限位参数	velocity_protect_time	速度禁止保持时间	10	10	10	10	ms																																																																																																																																																																																																																																																																																																																																																																																			
70	限位参数	acceleration_protect	加速度禁止	2	2	2	2	rpm																																																																																																																																																																																																																																																																																																																																																																																			
72	限位参数	acceleration_time	加速度禁止保持时间	10	10	10	10	ms																																																																																																																																																																																																																																																																																																																																																																																			
74	保护功能参数	following_error_enable_homing	跟踪误差使能	0	0	0	0	%																																																																																																																																																																																																																																																																																																																																																																																			
76	保护功能参数	following_error_time_homing	跟踪误差保持时间	4	4	4	16	ms																																																																																																																																																																																																																																																																																																																																																																																			
78	保护功能参数	following_error_time_homing	跟踪误差保持时间	4	4	4	16	ms																																																																																																																																																																																																																																																																																																																																																																																			
80	保护功能参数	following_error_time_homing	跟踪误差保持时间	200	200	200	1	ms																																																																																																																																																																																																																																																																																																																																																																																			
82	保护功能参数	max_position_protect	最大位置保护	0	0	0	0	%																																																																																																																																																																																																																																																																																																																																																																																			
84	保护功能参数	max_position_protect_time	最大位置保护保持时间	2	2	2	1	ms																																																																																																																																																																																																																																																																																																																																																																																			
86	保护功能参数	max_velocity_protect	最大速度保护	100	100	100	1	%																																																																																																																																																																																																																																																																																																																																																																																			
88	保护功能参数	max_velocity_protect_time	最大速度保护保持时间	200	200	200	1	ms																																																																																																																																																																																																																																																																																																																																																																																			
90	保护功能参数	max_acceleration_protect	最大加速度保护	0	0	0	0	%																																																																																																																																																																																																																																																																																																																																																																																			
92	保护功能参数	max_acceleration_protect_time	最大加速度保护保持时间	0	0	0	0	ms																																																																																																																																																																																																																																																																																																																																																																																			
94	保护功能参数	max_torque_protect	最大扭矩保护	0	0	0	0	%																																																																																																																																																																																																																																																																																																																																																																																			
96	保护功能参数	max_torque_protect_time	最大扭矩保护保持时间	0	0	0	0	ms																																																																																																																																																																																																																																																																																																																																																																																			
98	保护功能参数	max_force_protect	最大力保护	0	0	0	0	%																																																																																																																																																																																																																																																																																																																																																																																			
100	保护功能参数	max_force_protect_time	最大力保护保持时间	0	0	0	0	ms																																																																																																																																																																																																																																																																																																																																																																																			
102	保护功能参数	emergency_stop_enable	急停使能	0	0	0	0	%																																																																																																																																																																																																																																																																																																																																																																																			
104	保护功能参数	emergency_stop_time	急停保持时间	0	0	0	0	ms																																																																																																																																																																																																																																																																																																																																																																																			
106	回零参数	homing_method	回零方法	0	0	0	0	%																																																																																																																																																																																																																																																																																																																																																																																			
108	回零参数	homing_force	回零力	0	0	0	0	%																																																																																																																																																																																																																																																																																																																																																																																			
110	回零参数	homing_time	回零时间	0	0	0	0	ms																																																																																																																																																																																																																																																																																																																																																																																			
112	回零参数	homing_velocity	回零速度	0	0	0	0	rpm																																																																																																																																																																																																																																																																																																																																																																																			
114	回零参数	homing_acceleration	回零加速度	0	0	0	0	rpm																																																																																																																																																																																																																																																																																																																																																																																			
116	回零参数	homing_force_threshold	回零力阈值	100	100	100	1	%																																																																																																																																																																																																																																																																																																																																																																																			
118	回零参数	homing_force_threshold_time	回零力阈值保持时间	10	10	10	1	ms																																																																																																																																																																																																																																																																																																																																																																																			
120	回零参数	homing_z_signal	回零 z 信号	0	0	0	0	%																																																																																																																																																																																																																																																																																																																																																																																			
122	回零参数	homing_z_signal_time	回零 z 信号保持时间	0	0	0	0	ms																																																																																																																																																																																																																																																																																																																																																																																			
124	回零参数	homing_z_signal_force	回零 z 信号力	0	0	0	0	%																																																																																																																																																																																																																																																																																																																																																																																			
126	回零参数	homing_z_signal_force_time	回零 z 信号力保持时间	0	0	0	0	ms																																																																																																																																																																																																																																																																																																																																																																																			
128	回零参数	homing_z_signal_force_threshold	回零 z 信号力阈值	0	0	0	0	%																																																																																																																																																																																																																																																																																																																																																																																			
130	回零参数	homing_z_signal_force_threshold_time	回零 z 信号力阈值保持时间	0	0	0	0	ms																																																																																																																																																																																																																																																																																																																																																																																			
132	回零参数	homing_z_signal_force_threshold_force	回零 z 信号力阈值力	0	0	0	0	%																																																																																																																																																																																																																																																																																																																																																																																			
134	回零参数	homing_z_signal_force_threshold_force_time	回零 z 信号力阈值力保持时间	0	0	0	0	ms																																																																																																																																																																																																																																																																																																																																																																																			
136	回零参数	homing_z_signal_force_threshold_force_threshold	回零 z 信号力阈值力阈值	0	0	0	0	%																																																																																																																																																																																																																																																																																																																																																																																			
138	回零参数	homing_z_signal_force_threshold_force_threshold_time	回零 z 信号力阈值力阈值保持时间	0	0	0	0	ms																																																																																																																																																																																																																																																																																																																																																																																			
140	回零参数	homing_z_signal_force_threshold_force_threshold_force	回零 z 信号力阈值力阈值力	0	0	0	0	%																																																																																																																																																																																																																																																																																																																																																																																			
142	回零参数	homing_z_signal_force_threshold_force_threshold_force_time	回零 z 信号力阈值力阈值力保持时间	0	0	0	0	ms																																																																																																																																																																																																																																																																																																																																																																																			
2、参数 homing_method = 0 使用扭矩回零。																																																																																																																																																																																																																																																																																																																																																																																											
3、参数 homing_use_z_signal = 1 开启 z 信号辅助回零。																																																																																																																																																																																																																																																																																																																																																																																											
4、参数 homing_torque_threshold = 98 扭矩回零阈值设置为 98%。																																																																																																																																																																																																																																																																																																																																																																																											
5、ModePos = 4 运动模式切换到主动回零模式。																																																																																																																																																																																																																																																																																																																																																																																											
6、CancelTraversing = TRUE 让设备不暂停任务。																																																																																																																																																																																																																																																																																																																																																																																											
7、IntermediateStop = TRUE 让设备不取消任务。																																																																																																																																																																																																																																																																																																																																																																																											
8、EnableAxis=1 让电机使能。																																																																																																																																																																																																																																																																																																																																																																																											
9、等待时间 X 确保参数传输完毕, X 建议不小于 30 ms。																																																																																																																																																																																																																																																																																																																																																																																											
10、ExecuteMode = TRUE 该信号上升沿时启动任务,设备按照参数表设定的回零参数执行主动回零。																																																																																																																																																																																																																																																																																																																																																																																											

8.2.3.4.3.4.3 硬限位回零

主动回零模式-使用硬限位信号方式	
步骤	图示
1、参数 limit_protect_enable = 1 使能硬限位功能。	
2、设置参数 limit_switch_polarity = 0(常开型) 或 = 1(常闭型) 根据硬件开关输出极性设置常开型或常闭型。	
3、参数 homing_method = 1 使用限位回零。	
4、参数 homing_use_z_signal = 0 关闭 z 信号辅助回零。	
5、ModePos = 4 使设备运动模式切换到主动回零模式并使能。	
6、CancelTraversing = TRUE 让设备不暂停任务。	
7、IntermediateStop = TRUE 让设备不取消任务。	
8、EnableAxis=1 让电机使能。	
9、等待时间 X 确保参数传输完毕, X 建议不小于 30 ms。	
10、ExecuteMode = TRUE 该信号上升沿时启动任务,设备按照参数表设定的回零参数执行主动回零。	

8.2.3.4.3.4.4 硬限位+编码器 z 信号

主动回零模式-使用硬限位信号方式+编码器 z 信号	
步骤	图示
1、参数 limit_protect_enable = 1 使能硬限位功能。	
2、设置参数 limit_switch_polarity = 0(常开型) 或 = 1(常闭型) 根据硬件开关输出极性设置常开型或常闭型。	
3、参数 homing_method = 1 使用限位回零。	
4、参数 homing_use_z_signal = 1 开启 z 信号辅助回零。	
5、ModePos = 4 使设备运动模式切换到主动回零模式并使能。	
6、CancelTraversing = TRUE 让设备不暂停任务。	
7、IntermediateStop = TRUE 让设备不取消任务。	
8、EnableAxis=1 让电机使能。	
9、等待时间 X 确保参数传输完毕, X 建议不小于 30 ms。	
10、ExecuteMode = TRUE 该信号上升沿时启动任务,设备按照参数表设定的回零参数执行主动回零。	

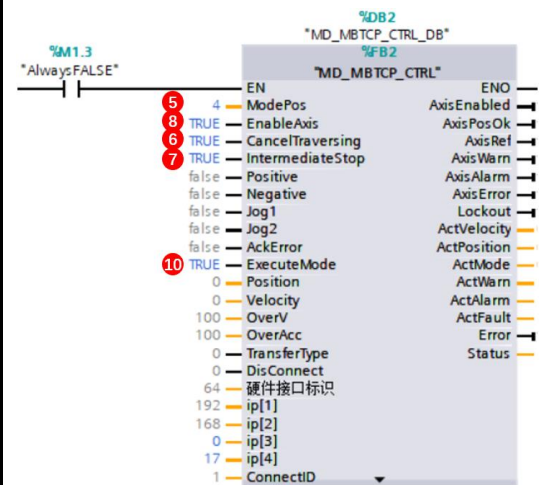

8.2.3.4.3.5 零点设置模式

零点设置模式	
步骤	图示
1、ModePos = 5 运动模式切换到零点设置模式。	
2、CancelTraversing = TRUE 让设备不暂停任务。	
3、IntermediateStop = TRUE 让设备不取消任务。	
4、EnableAxis=1 让电机使能。	
5、等待时间 X 确保参数传输完毕, X 建议不小于 30 ms。	
6、ExecuteMode = TRUE 该信号上升沿时启动任务,设备将当前的位置设置为零点。	

8.2.3.4.3.6 程序块模式

8.2.3.4.3.6.1 单次运行模式

程序块模式-单次运行模式	
步骤	图示
1、参数 program_block_operation_mode = 0 程序块运行模式设置为单次运行模式。	
2、参数 program_block_start_step = 1 程序块起始步设置为 1。	
3、参数 program_block_end_step = 2 程序块结束步设置为 2。	
4、参数 program_block_step[1].Xtarget = 0 程序步 1 目标位置设置为 0 lu。	
5、参数 program_block_step[1].Vtarget = 5000 程序步 1 目标速度设置为 5000 lu/s。	
6、参数 program_block_step[1].delay = 500 程序步 1 延时设置为 500 ms。	
7、参数 program_block_step[2].Xtarget = 10000 程序步 2 目标位置设置为 10000 lu。	
8、参数 program_block_step[2].Vtarget = 5000 程序步 2 目标速度设置为 5000 lu/s。	
9、参数 program_block_step[2].delay = 500 程序步 2 延时设置为 500 ms。	
10、检查 AxisRef 等于 TRUE 确认轴已回零。设备程序块模式需要零点作为的参考点。	
11、ModePos = 6 运动模式切换到程序块模式。	
12、CancelTraversing = TRUE 让设备不暂停任务。	
13、IntermediateStop = TRUE 让设备不取消任务。	
14、TransferType = TRUE (按需设定) 开启设定值连续传输，使程序步的当前步完成后继续执行下一步。	
15、EnableAxis=1 让电机使能。	
16、等待时间 X 确保参数传输完毕，X 建议不小于 30 ms。	
17、ExecuteMode = TRUE 该信号上升沿时启动任务,设备按照程序块参数执行程序块模式运动。	

8.2.3.4.3.6.2 循环运行模式

程序块模式-循环运行模式	
步骤	图示
1、软件参数 program_block_operation_mode = 1 程序块运行模式设置为循环运行模式。	
2、软件参数 program_block_start_step = 1 程序块起始步设置为 1。	
3、软件参数 program_block_end_step = 2 程序块结束步设置为 2。	
4、软件参数 program_block_step[1].Xtarget = 0 程序步 1 目标位置设置为 0 lu。	
5、软件参数 program_block_step[1].Vtarget = 5000 程序步 1 目标速度设置为 5000 lu/s。	
6、软件参数 program_block_step[1].delay = 500 程序步 1 延时设置为 500 ms。	
7、软件参数 program_block_step[2].Xtarget = 10000 程序步 2 目标位置设置为 10000 lu。	
8、软件参数 program_block_step[2].Vtarget = 5000 程序步 2 目标速度设置为 5000 lu/s。	
9、软件参数 program_block_step[2].delay = 500 程序步 2 延时设置为 500 ms。	
10、检查 AxisRef 等于 TRUE 确认轴已回零。设备程序块模式需要零点作为的参考点。	
11、ModePos = 6 运动模式切换到程序块模式。	
12、CancelTraversing = TRUE 让设备不暂停任务。	
13、IntermediateStop = TRUE 让设备不取消任务。	
14、TransferType = TRUE (按需设定) 开启设定值连续传输，使程序步当前步完成后继续执行下一步。	
15、EnableAxis=1 让电机使能。	
16、等待时间 X 确保参数传输完毕，X 建议不小于 30 ms。	
17、ExecuteMode = TRUE 该信号上升沿时启动任务,设备按照程序块参数执行程序块模式运动。	

8.2.3.4.3.7 点动模式

点动模式																																																																																																																																																																																																																																																																																																																																																																																																																											
步骤	图示																																																																																																																																																																																																																																																																																																																																																																																																																										
<p>1、参数 jog_velocity = 60 设置点动速度为 60rpm。</p>	<table border="1"> <thead> <tr> <th>参数名</th> <th>数据类型</th> <th>参数名</th> <th>模式</th> <th>设置值</th> <th>初始值</th> <th>出厂值</th> <th>最小值</th> <th>最大值</th> <th>单位</th> </tr> </thead> <tbody> <tr> <td>110</td> <td>整数参数</td> <td>homeing_time_sigmoid</td> <td>线性插值的斜率</td> <td>14</td> <td>10</td> <td>1</td> <td>0</td> <td>1</td> <td>s</td> </tr> <tr> <td>111</td> <td>整数参数</td> <td>homeing_velocity</td> <td>线性插值的速度</td> <td>140</td> <td>140</td> <td>140</td> <td>1</td> <td>140</td> <td>rpm</td> </tr> <tr> <td>114</td> <td>整数参数</td> <td>homeing_velocity2</td> <td>线性插值的速度2</td> <td>10</td> <td>10</td> <td>10</td> <td>1</td> <td>100</td> <td>rpm</td> </tr> <tr> <td>115</td> <td>整数参数</td> <td>homeing_velocity3</td> <td>线性插值的速度3</td> <td>100</td> <td>100</td> <td>100</td> <td>1</td> <td>100</td> <td>rpm</td> </tr> <tr> <td>118</td> <td>整数参数</td> <td>homeing_velocity_time</td> <td>线性插值的速度时间</td> <td>10</td> <td>10</td> <td>10</td> <td>1</td> <td>1000</td> <td>ms</td> </tr> <tr> <td>120</td> <td>整数参数</td> <td>home_time</td> <td>线性插值的时间</td> <td>0</td> <td>0</td> <td>0</td> <td>0</td> <td>-147493667</td> <td>ms</td> </tr> <tr> <td>122</td> <td></td> <td></td> <td></td> <td></td> <td></td> <td></td> <td></td> <td></td> <td></td> </tr> <tr> <td>124</td> <td></td> <td></td> <td></td> <td></td> <td></td> <td></td> <td></td> <td></td> <td></td> </tr> <tr> <td>126</td> <td></td> <td></td> <td></td> <td></td> <td></td> <td></td> <td></td> <td></td> <td></td> </tr> <tr> <td>130</td> <td>系统参数</td> <td>jog_velocity</td> <td>点动速度</td> <td>60</td> <td>60</td> <td></td> <td></td> <td></td> <td>rpm</td> </tr> <tr> <td>132</td> <td>系统参数</td> <td>plc_runtime_address</td> <td>PLC运行地址</td> <td>2</td> <td>2</td> <td>0</td> <td>16</td> <td></td> <td>7" hex</td> </tr> <tr> <td>134</td> <td>程序参数</td> <td>program_block_operation_mode</td> <td>程序块运行模式</td> <td>1=自由 2=解除运行模式</td> <td>0</td> <td>0</td> <td>0</td> <td>1</td> <td></td> </tr> <tr> <td>136</td> <td>程序参数</td> <td>program_block_run_time</td> <td>程序块运行时间</td> <td>1</td> <td>1</td> <td>1</td> <td>1</td> <td>1</td> <td></td> </tr> <tr> <td>138</td> <td>程序参数</td> <td>program_block_run_time2</td> <td>程序块运行时间2</td> <td>2</td> <td>2</td> <td>1</td> <td>1</td> <td>1</td> <td></td> </tr> <tr> <td>140</td> <td>程序参数</td> <td>program_block_run_time3</td> <td>程序块运行时间3</td> <td>3</td> <td>3</td> <td>0</td> <td>0</td> <td>-147493667</td> <td>ms</td> </tr> <tr> <td>142</td> <td>程序参数</td> <td>program_block_run_time4</td> <td>程序块运行时间4</td> <td>4</td> <td>4</td> <td>0</td> <td>0</td> <td>-147493667</td> <td>ms</td> </tr> <tr> <td>144</td> <td>程序参数</td> <td>program_block_run_time5</td> <td>程序块运行时间5</td> <td>5</td> <td>5</td> <td>0</td> <td>0</td> <td>-147493667</td> <td>ms</td> </tr> <tr> <td>146</td> <td>程序参数</td> <td>program_block_run_time6</td> <td>程序块运行时间6</td> <td>6</td> <td>6</td> <td>0</td> <td>0</td> <td>-147493667</td> <td>ms</td> </tr> <tr> <td>148</td> <td>程序参数</td> <td>program_block_run_time7</td> <td>程序块运行时间7</td> <td>7</td> <td>7</td> <td>0</td> <td>0</td> <td>-147493667</td> <td>ms</td> </tr> <tr> <td>150</td> <td>程序参数</td> <td>program_block_run_time8</td> <td>程序块运行时间8</td> <td>8</td> <td>8</td> <td>0</td> <td>0</td> <td>-147493667</td> <td>ms</td> </tr> <tr> <td>152</td> <td>程序参数</td> <td>program_block_run_time9</td> <td>程序块运行时间9</td> <td>9</td> <td>9</td> <td>0</td> <td>0</td> <td>-147493667</td> <td>ms</td> </tr> <tr> <td>154</td> <td>程序参数</td> <td>program_block_run_time10</td> <td>程序块运行时间10</td> <td>10</td> <td>10</td> <td>0</td> <td>0</td> <td>-147493667</td> <td>ms</td> </tr> <tr> <td>156</td> <td>程序参数</td> <td>program_block_run_time11</td> <td>程序块运行时间11</td> <td>11</td> <td>11</td> <td>0</td> <td>0</td> <td>-147493667</td> <td>ms</td> </tr> <tr> <td>158</td> <td>程序参数</td> <td>program_block_run_time12</td> <td>程序块运行时间12</td> <td>12</td> <td>12</td> <td>0</td> <td>0</td> <td>-147493667</td> <td>ms</td> </tr> <tr> <td>160</td> <td>程序参数</td> <td>program_block_run_time13</td> <td>程序块运行时间13</td> <td>13</td> <td>13</td> <td>0</td> <td>0</td> <td>-147493667</td> <td>ms</td> </tr> <tr> <td>162</td> <td>程序参数</td> <td>program_block_run_time14</td> <td>程序块运行时间14</td> <td>14</td> <td>14</td> <td>0</td> <td>0</td> <td>-147493667</td> <td>ms</td> </tr> <tr> <td>164</td> <td>程序参数</td> <td>program_block_run_time15</td> <td>程序块运行时间15</td> <td>15</td> <td>15</td> <td>0</td> <td>0</td> <td>-147493667</td> <td>ms</td> </tr> <tr> <td>166</td> <td>程序参数</td> <td>program_block_run_time16</td> <td>程序块运行时间16</td> <td>16</td> <td>16</td> <td>0</td> <td>0</td> <td>-147493667</td> <td>ms</td> </tr> <tr> <td>168</td> <td>程序参数</td> <td>program_block_run_time17</td> <td>程序块运行时间17</td> <td>17</td> <td>17</td> <td>0</td> <td>0</td> <td>-147493667</td> <td>ms</td> </tr> <tr> <td>170</td> <td>程序参数</td> <td>program_block_run_time18</td> <td>程序块运行时间18</td> <td>18</td> <td>18</td> <td>0</td> <td>0</td> <td>-147493667</td> <td>ms</td> </tr> <tr> <td>172</td> <td>程序参数</td> <td>program_block_run_time19</td> <td>程序块运行时间19</td> <td>19</td> <td>19</td> <td>0</td> <td>0</td> <td>-147493667</td> <td>ms</td> </tr> <tr> <td>174</td> <td>程序参数</td> <td>program_block_run_time20</td> <td>程序块运行时间20</td> <td>20</td> <td>20</td> <td>0</td> <td>0</td> <td>-147493667</td> <td>ms</td> </tr> <tr> <td>176</td> <td>程序参数</td> <td>program_block_run_time21</td> <td>程序块运行时间21</td> <td>21</td> <td>21</td> <td>0</td> <td>0</td> <td>-147493667</td> <td>ms</td> </tr> <tr> <td>178</td> <td>程序参数</td> <td>program_block_run_time22</td> <td>程序块运行时间22</td> <td>22</td> <td>22</td> <td>0</td> <td>0</td> <td>-147493667</td> <td>ms</td> </tr> <tr> <td>180</td> <td>程序参数</td> <td>program_block_run_time23</td> <td>程序块运行时间23</td> <td>23</td> <td>23</td> <td>0</td> <td>0</td> <td>-147493667</td> <td>ms</td> </tr> <tr> <td>182</td> <td>程序参数</td> <td>program_block_run_time24</td> <td>程序块运行时间24</td> <td>24</td> <td>24</td> <td>0</td> <td>0</td> <td>-147493667</td> <td>ms</td> </tr> <tr> <td>184</td> <td>程序参数</td> <td>program_block_run_time25</td> <td>程序块运行时间25</td> <td>25</td> <td>25</td> <td>0</td> <td>0</td> <td>-147493667</td> <td>ms</td> </tr> <tr> <td>186</td> <td>程序参数</td> <td>program_block_run_time26</td> <td>程序块运行时间26</td> <td>26</td> <td>26</td> <td>0</td> <td>0</td> <td>-147493667</td> <td>ms</td> </tr> <tr> <td>188</td> <td>程序参数</td> <td>program_block_run_time27</td> <td>程序块运行时间27</td> <td>27</td> <td>27</td> <td>0</td> <td>0</td> <td>-147493667</td> <td>ms</td> </tr> <tr> <td>190</td> <td>程序参数</td> <td>program_block_run_time28</td> <td>程序块运行时间28</td> <td>28</td> <td>28</td> <td>0</td> <td>0</td> <td>-147493667</td> <td>ms</td> </tr> </tbody> </table>	参数名	数据类型	参数名	模式	设置值	初始值	出厂值	最小值	最大值	单位	110	整数参数	homeing_time_sigmoid	线性插值的斜率	14	10	1	0	1	s	111	整数参数	homeing_velocity	线性插值的速度	140	140	140	1	140	rpm	114	整数参数	homeing_velocity2	线性插值的速度2	10	10	10	1	100	rpm	115	整数参数	homeing_velocity3	线性插值的速度3	100	100	100	1	100	rpm	118	整数参数	homeing_velocity_time	线性插值的速度时间	10	10	10	1	1000	ms	120	整数参数	home_time	线性插值的时间	0	0	0	0	-147493667	ms	122										124										126										130	系统参数	jog_velocity	点动速度	60	60				rpm	132	系统参数	plc_runtime_address	PLC运行地址	2	2	0	16		7" hex	134	程序参数	program_block_operation_mode	程序块运行模式	1=自由 2=解除运行模式	0	0	0	1		136	程序参数	program_block_run_time	程序块运行时间	1	1	1	1	1		138	程序参数	program_block_run_time2	程序块运行时间2	2	2	1	1	1		140	程序参数	program_block_run_time3	程序块运行时间3	3	3	0	0	-147493667	ms	142	程序参数	program_block_run_time4	程序块运行时间4	4	4	0	0	-147493667	ms	144	程序参数	program_block_run_time5	程序块运行时间5	5	5	0	0	-147493667	ms	146	程序参数	program_block_run_time6	程序块运行时间6	6	6	0	0	-147493667	ms	148	程序参数	program_block_run_time7	程序块运行时间7	7	7	0	0	-147493667	ms	150	程序参数	program_block_run_time8	程序块运行时间8	8	8	0	0	-147493667	ms	152	程序参数	program_block_run_time9	程序块运行时间9	9	9	0	0	-147493667	ms	154	程序参数	program_block_run_time10	程序块运行时间10	10	10	0	0	-147493667	ms	156	程序参数	program_block_run_time11	程序块运行时间11	11	11	0	0	-147493667	ms	158	程序参数	program_block_run_time12	程序块运行时间12	12	12	0	0	-147493667	ms	160	程序参数	program_block_run_time13	程序块运行时间13	13	13	0	0	-147493667	ms	162	程序参数	program_block_run_time14	程序块运行时间14	14	14	0	0	-147493667	ms	164	程序参数	program_block_run_time15	程序块运行时间15	15	15	0	0	-147493667	ms	166	程序参数	program_block_run_time16	程序块运行时间16	16	16	0	0	-147493667	ms	168	程序参数	program_block_run_time17	程序块运行时间17	17	17	0	0	-147493667	ms	170	程序参数	program_block_run_time18	程序块运行时间18	18	18	0	0	-147493667	ms	172	程序参数	program_block_run_time19	程序块运行时间19	19	19	0	0	-147493667	ms	174	程序参数	program_block_run_time20	程序块运行时间20	20	20	0	0	-147493667	ms	176	程序参数	program_block_run_time21	程序块运行时间21	21	21	0	0	-147493667	ms	178	程序参数	program_block_run_time22	程序块运行时间22	22	22	0	0	-147493667	ms	180	程序参数	program_block_run_time23	程序块运行时间23	23	23	0	0	-147493667	ms	182	程序参数	program_block_run_time24	程序块运行时间24	24	24	0	0	-147493667	ms	184	程序参数	program_block_run_time25	程序块运行时间25	25	25	0	0	-147493667	ms	186	程序参数	program_block_run_time26	程序块运行时间26	26	26	0	0	-147493667	ms	188	程序参数	program_block_run_time27	程序块运行时间27	27	27	0	0	-147493667	ms	190	程序参数	program_block_run_time28	程序块运行时间28	28	28	0	0	-147493667	ms
参数名	数据类型	参数名	模式	设置值	初始值	出厂值	最小值	最大值	单位																																																																																																																																																																																																																																																																																																																																																																																																																		
110	整数参数	homeing_time_sigmoid	线性插值的斜率	14	10	1	0	1	s																																																																																																																																																																																																																																																																																																																																																																																																																		
111	整数参数	homeing_velocity	线性插值的速度	140	140	140	1	140	rpm																																																																																																																																																																																																																																																																																																																																																																																																																		
114	整数参数	homeing_velocity2	线性插值的速度2	10	10	10	1	100	rpm																																																																																																																																																																																																																																																																																																																																																																																																																		
115	整数参数	homeing_velocity3	线性插值的速度3	100	100	100	1	100	rpm																																																																																																																																																																																																																																																																																																																																																																																																																		
118	整数参数	homeing_velocity_time	线性插值的速度时间	10	10	10	1	1000	ms																																																																																																																																																																																																																																																																																																																																																																																																																		
120	整数参数	home_time	线性插值的时间	0	0	0	0	-147493667	ms																																																																																																																																																																																																																																																																																																																																																																																																																		
122																																																																																																																																																																																																																																																																																																																																																																																																																											
124																																																																																																																																																																																																																																																																																																																																																																																																																											
126																																																																																																																																																																																																																																																																																																																																																																																																																											
130	系统参数	jog_velocity	点动速度	60	60				rpm																																																																																																																																																																																																																																																																																																																																																																																																																		
132	系统参数	plc_runtime_address	PLC运行地址	2	2	0	16		7" hex																																																																																																																																																																																																																																																																																																																																																																																																																		
134	程序参数	program_block_operation_mode	程序块运行模式	1=自由 2=解除运行模式	0	0	0	1																																																																																																																																																																																																																																																																																																																																																																																																																			
136	程序参数	program_block_run_time	程序块运行时间	1	1	1	1	1																																																																																																																																																																																																																																																																																																																																																																																																																			
138	程序参数	program_block_run_time2	程序块运行时间2	2	2	1	1	1																																																																																																																																																																																																																																																																																																																																																																																																																			
140	程序参数	program_block_run_time3	程序块运行时间3	3	3	0	0	-147493667	ms																																																																																																																																																																																																																																																																																																																																																																																																																		
142	程序参数	program_block_run_time4	程序块运行时间4	4	4	0	0	-147493667	ms																																																																																																																																																																																																																																																																																																																																																																																																																		
144	程序参数	program_block_run_time5	程序块运行时间5	5	5	0	0	-147493667	ms																																																																																																																																																																																																																																																																																																																																																																																																																		
146	程序参数	program_block_run_time6	程序块运行时间6	6	6	0	0	-147493667	ms																																																																																																																																																																																																																																																																																																																																																																																																																		
148	程序参数	program_block_run_time7	程序块运行时间7	7	7	0	0	-147493667	ms																																																																																																																																																																																																																																																																																																																																																																																																																		
150	程序参数	program_block_run_time8	程序块运行时间8	8	8	0	0	-147493667	ms																																																																																																																																																																																																																																																																																																																																																																																																																		
152	程序参数	program_block_run_time9	程序块运行时间9	9	9	0	0	-147493667	ms																																																																																																																																																																																																																																																																																																																																																																																																																		
154	程序参数	program_block_run_time10	程序块运行时间10	10	10	0	0	-147493667	ms																																																																																																																																																																																																																																																																																																																																																																																																																		
156	程序参数	program_block_run_time11	程序块运行时间11	11	11	0	0	-147493667	ms																																																																																																																																																																																																																																																																																																																																																																																																																		
158	程序参数	program_block_run_time12	程序块运行时间12	12	12	0	0	-147493667	ms																																																																																																																																																																																																																																																																																																																																																																																																																		
160	程序参数	program_block_run_time13	程序块运行时间13	13	13	0	0	-147493667	ms																																																																																																																																																																																																																																																																																																																																																																																																																		
162	程序参数	program_block_run_time14	程序块运行时间14	14	14	0	0	-147493667	ms																																																																																																																																																																																																																																																																																																																																																																																																																		
164	程序参数	program_block_run_time15	程序块运行时间15	15	15	0	0	-147493667	ms																																																																																																																																																																																																																																																																																																																																																																																																																		
166	程序参数	program_block_run_time16	程序块运行时间16	16	16	0	0	-147493667	ms																																																																																																																																																																																																																																																																																																																																																																																																																		
168	程序参数	program_block_run_time17	程序块运行时间17	17	17	0	0	-147493667	ms																																																																																																																																																																																																																																																																																																																																																																																																																		
170	程序参数	program_block_run_time18	程序块运行时间18	18	18	0	0	-147493667	ms																																																																																																																																																																																																																																																																																																																																																																																																																		
172	程序参数	program_block_run_time19	程序块运行时间19	19	19	0	0	-147493667	ms																																																																																																																																																																																																																																																																																																																																																																																																																		
174	程序参数	program_block_run_time20	程序块运行时间20	20	20	0	0	-147493667	ms																																																																																																																																																																																																																																																																																																																																																																																																																		
176	程序参数	program_block_run_time21	程序块运行时间21	21	21	0	0	-147493667	ms																																																																																																																																																																																																																																																																																																																																																																																																																		
178	程序参数	program_block_run_time22	程序块运行时间22	22	22	0	0	-147493667	ms																																																																																																																																																																																																																																																																																																																																																																																																																		
180	程序参数	program_block_run_time23	程序块运行时间23	23	23	0	0	-147493667	ms																																																																																																																																																																																																																																																																																																																																																																																																																		
182	程序参数	program_block_run_time24	程序块运行时间24	24	24	0	0	-147493667	ms																																																																																																																																																																																																																																																																																																																																																																																																																		
184	程序参数	program_block_run_time25	程序块运行时间25	25	25	0	0	-147493667	ms																																																																																																																																																																																																																																																																																																																																																																																																																		
186	程序参数	program_block_run_time26	程序块运行时间26	26	26	0	0	-147493667	ms																																																																																																																																																																																																																																																																																																																																																																																																																		
188	程序参数	program_block_run_time27	程序块运行时间27	27	27	0	0	-147493667	ms																																																																																																																																																																																																																																																																																																																																																																																																																		
190	程序参数	program_block_run_time28	程序块运行时间28	28	28	0	0	-147493667	ms																																																																																																																																																																																																																																																																																																																																																																																																																		
<p>2、ModePos = 7 使设备模式切换到点动模式。</p>	<pre> %DB2 "MD_MBTCP_CTRL_DB" %FB2 "MD_MBTCP_CTRL" EN ModePos 7 EnableAxis TRUE CancelTraversing TRUE IntermediateStop TRUE Positive false Negative false Jog1 4 Jog2 5 AckError false ExecuteMode false Position 0 Velocity 0 OverV 100 OverAcc 100 TransferType 0 DisConnect 0 硬件接口标识 64 ip[1] 192 ip[2] 168 ip[3] 0 ip[4] 17 ConnectID 1 AxisEnabled false AxisPosOk false AxisRef false AxisWarn false AxisAlarm false AxisError false Lockout false ActVelocity 0 ActPosition 0 ActMode 0 ActWarn 16#0 ActAlarm 16#0 ActFault 16#0 Error false Status 16#0 </pre>																																																																																																																																																																																																																																																																																																																																																																																																																										
<p>3、EnableAxis = TRUE 使能电机。</p>																																																																																																																																																																																																																																																																																																																																																																																																																											
<p>4、Jog1 = 1 信号为 1 时，设备以 60rpm 的速度向正方向旋转。</p>																																																																																																																																																																																																																																																																																																																																																																																																																											
<p>5、Jog1 = 0 复位正转信号，设备停止正转。</p>																																																																																																																																																																																																																																																																																																																																																																																																																											

8.2.3.4.3.8 寸动模式

寸动模式	
步骤	图示
<p>1、参数 jog_velocity = 60 设置点动速度为 60rpm。(寸动速度=点动速度)</p>	
<p>2、参数 jog_increase_distance = -2 设置寸动距离为-2，即 2 的-2 次方，为 0.25 圈。</p>	
<p>3、ModePos = 8 使设备模式切换到寸动模式。</p>	
<p>4、EnableAxis = TRUE 使能电机。</p>	
<p>5、Jog1 = 1 该信号上升沿时启动任务,设备往正方向旋转 0.25 圈。</p>	

8.3 西门子 S7-200 SMART 样例(PROFINET)

8.3.1 涉及软硬件

硬件： 1、S7-200 smart ST20

2、百川 MD 系列 PROFINET 一体式步进伺服

3、计算机

4、网线

5、交换机

软件： STEP 7-MicroWIN SMART、BCZY DTools



配置文件： GSDML-V2.32-BCZY-MDSERIES-MODULE-20251110.xml

库文件： BCMD_LIB.smartlib

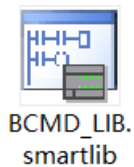

8.3.2 硬件连接

8.3.2.1 建立连接

本一体式步进伺服采用 DC 24V ($\pm 15\%$) 输入，本样例将使用 AC100-240V 转 DC24V 作为输入电源。

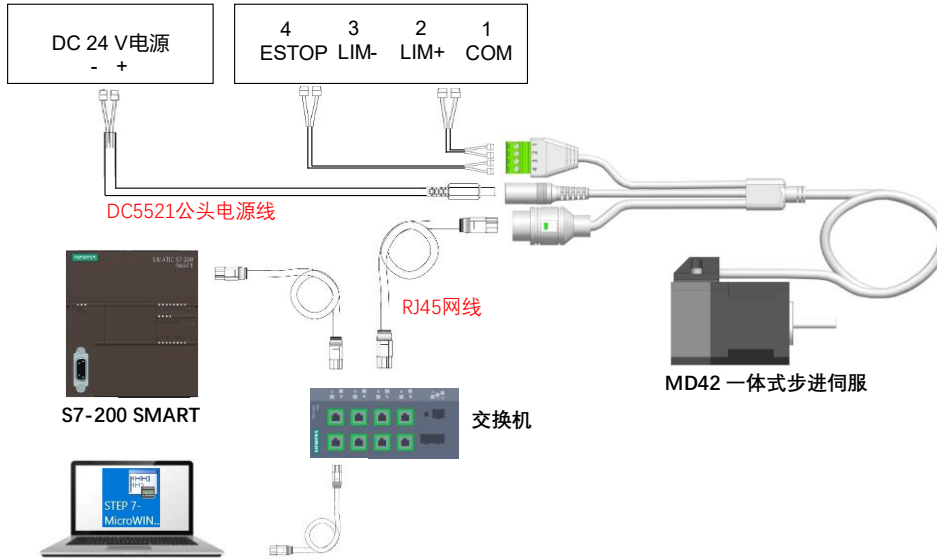

使用 DC5521 公头电源线将 DC24V 接入一体式步进伺服 DC5521 母头。

通过标准 RJ45 网线将调试计算机、PLC、一体式步进伺服连接到交换机组网。

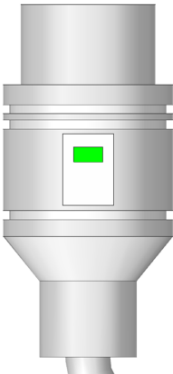

8.3.2.2 检查系统指示灯

电源通电后，未完成组态时，状态如下表状态 2 间隔短闪。

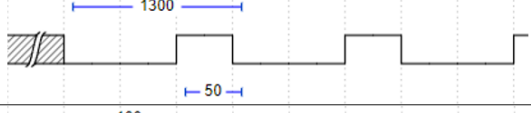
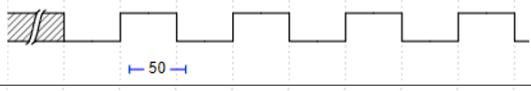
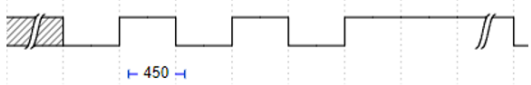
LED灯	状态	LED闪烁波形(单位:ms)
	1、常亮。控制器已连接通信正常	
	2、间隔短闪。无控制器连接	
	3、快闪。设备初始化	
	4、周期闪烁三次后恢复1/2/3状态。查找设备功能	

8.3.3 添加配置文件

根据文件所在目录切换路径，导入 GSD 文件。

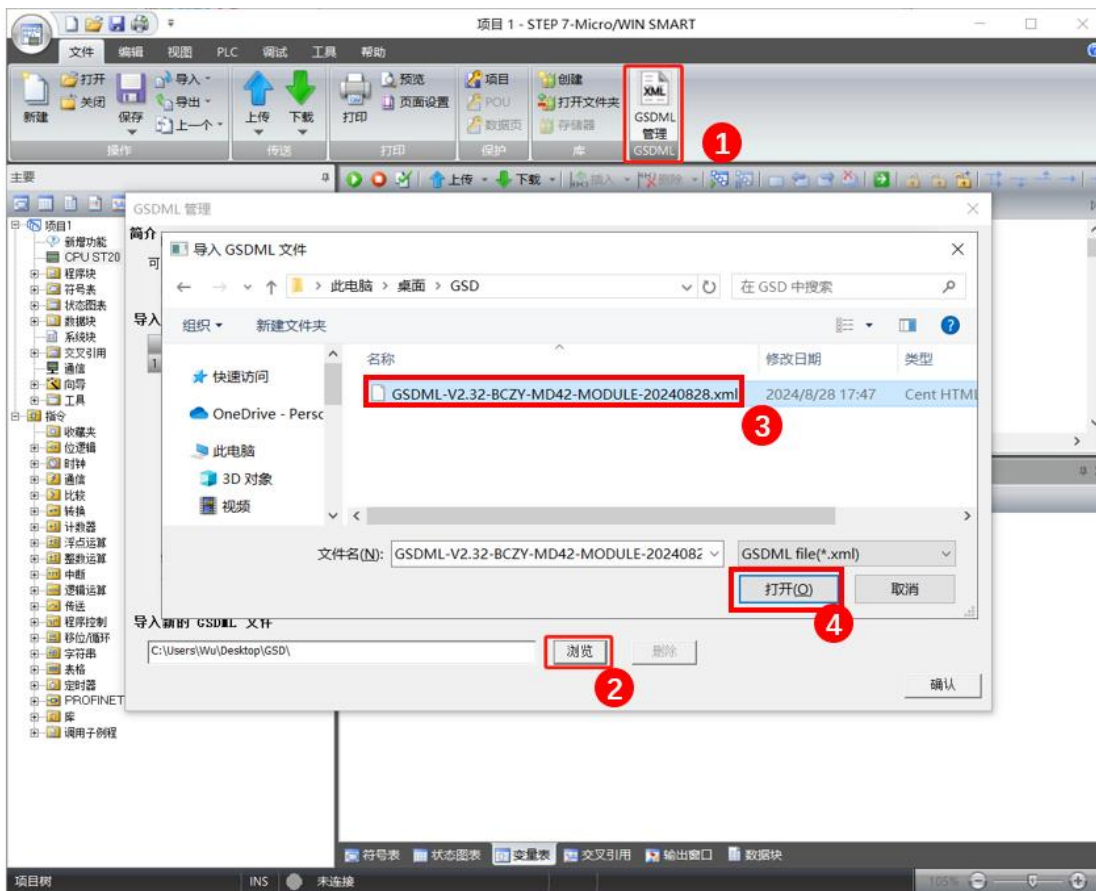

8.3.4 组态

8.3.4.1 PLC 配置

设置控制器 PLC 地址，此样例 PLC 控制器 IP 地址设置为 192.168.200.191

系统块 -> 选择 CPU 型号 -> 填入 IP 地址与子网掩码 -> 确定

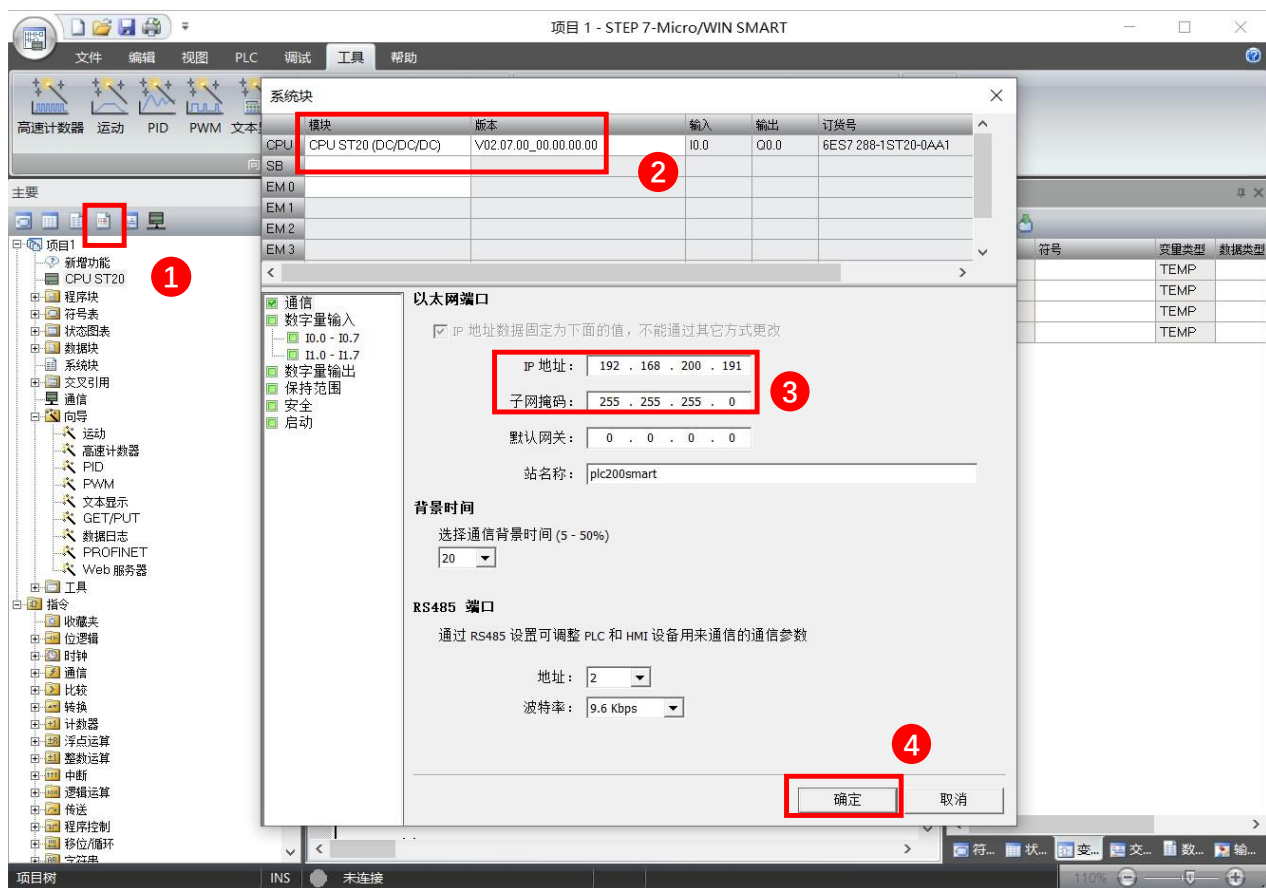

8.3.4.2 PROFINET 配置向导

8.3.4.2.1 配置控制器

向导-> PROFINET 中选择 PLC 角色为控制器，并且设置控制器的 IP 地址，如下图所示。

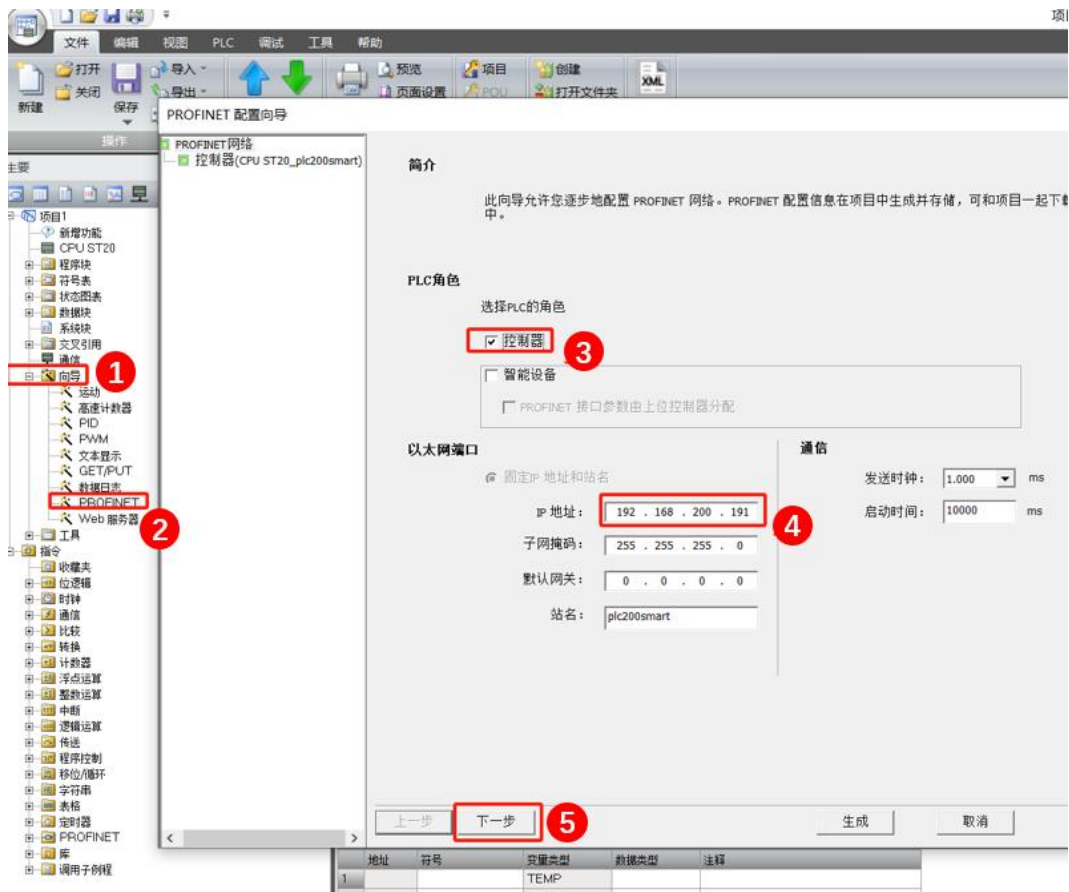

8.3.4.2.2 添加 PROFINET 设备

从硬件目录中 PROFINET-IO, Drives, BCZY, BCZY_Drives 下, 选择刚刚添加好的设备, 拖放至设备表中。

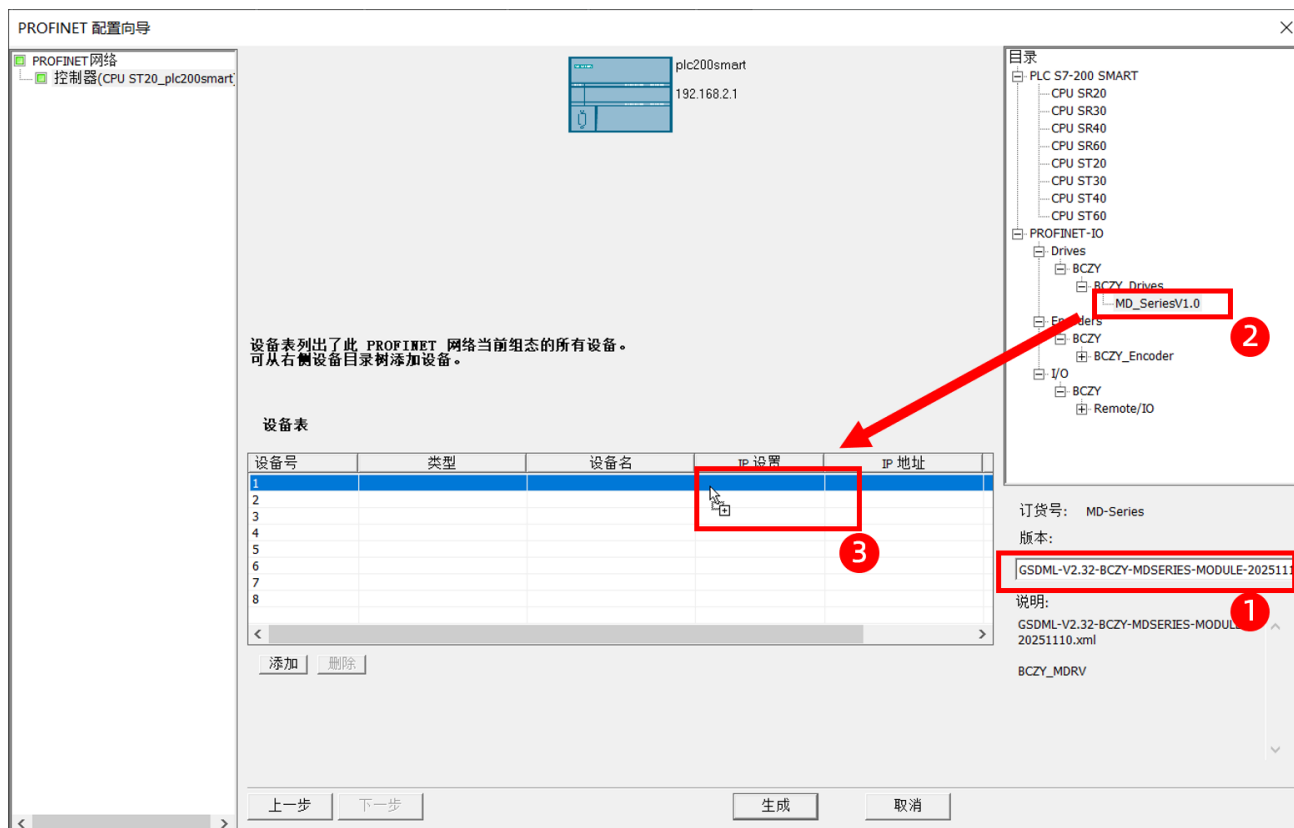

确认 GSD 版本与添加的文件为同一版本

8.3.4.2.3 设置 PROFINET 设备

本样例用默认的设备名称 **md-dev.dev1**，设定 IP 地址为 **192.168.200.192** 如下图所示。

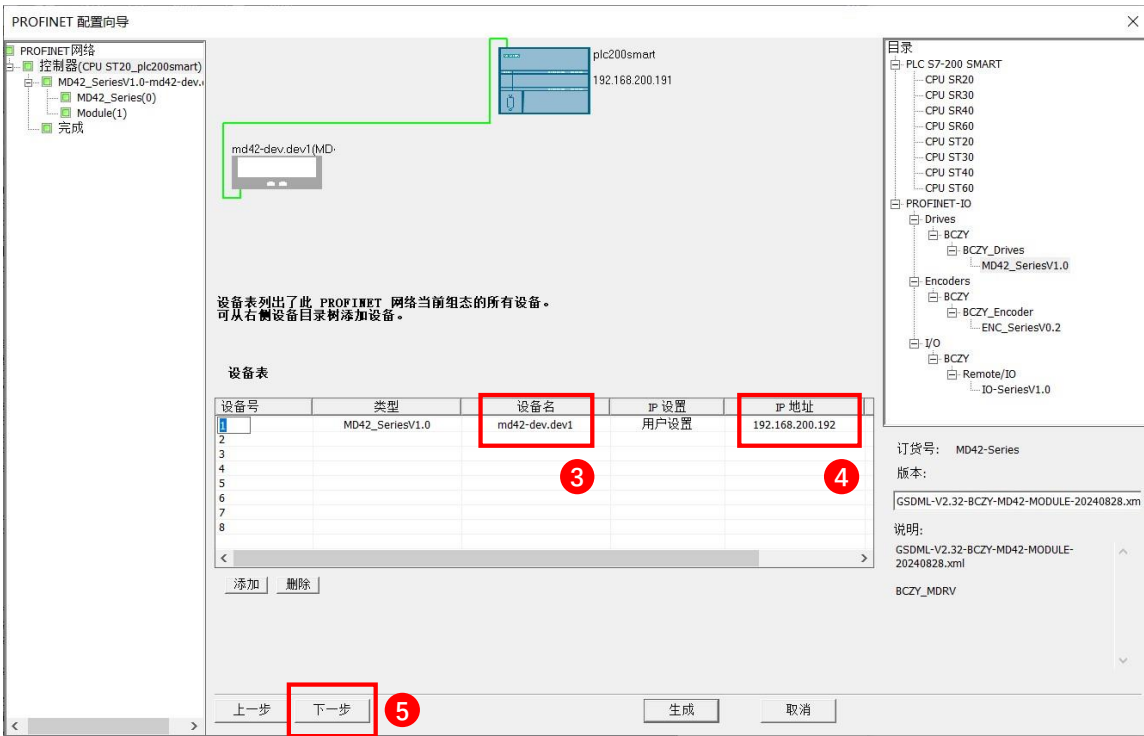

8.3.4.2.4 添加控制报文

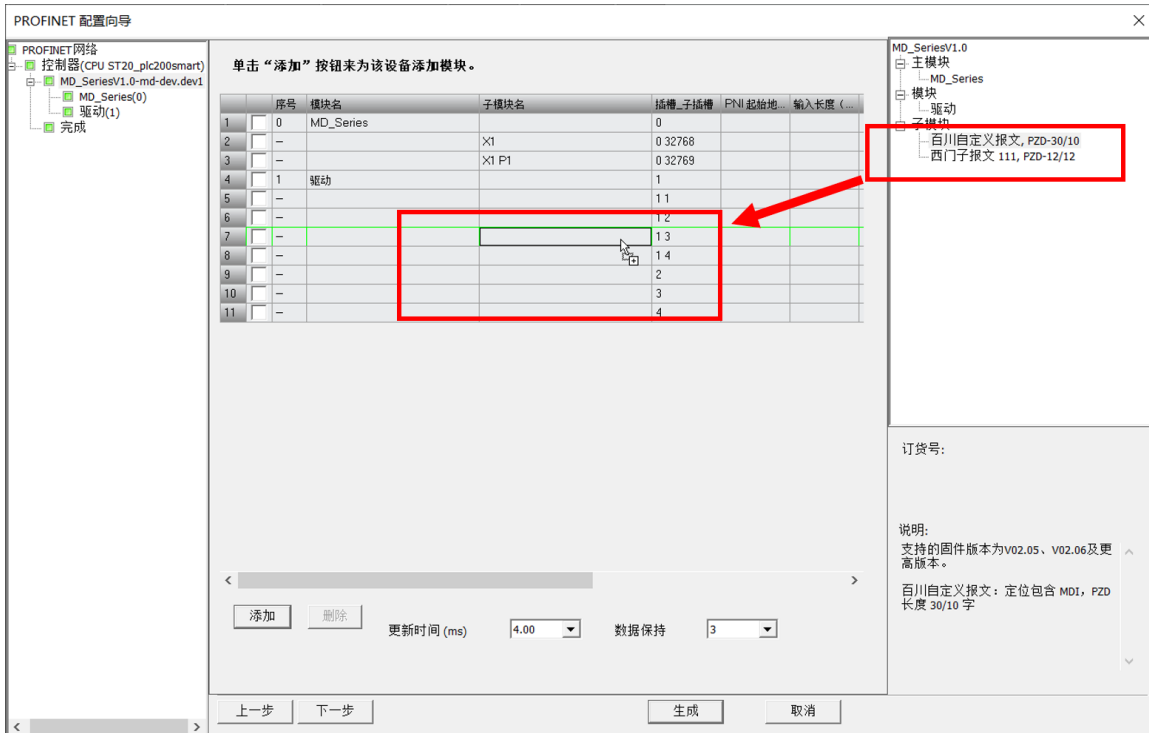

8.3.4.2.5 查看信息

(7) I/O 映射区 (8) I/O 周期更新时间(ms)

PROFINET 配置向导

单击“添加”按钮来为该设备添加模块。

序号	模块名	子模块名	插槽_子插槽	PNI 起始地	输入长度	PNO 起始地	输出长度
1	MD_Series		0				
2		X1		0 32768			
3		X1 P1		0 32769			
4	1	驱动					1
5							1.1
6							1.2
7		百川自定义报文, PZD-30/10	1.3	128	60	128	20
8							1.4
9							2
10							3
11							4

更新时间 (ms) 4.00 数据保持 3

生成

MD_SeriesV1.0
主模块
MD_Series
模块
驱动
子模块
百川自定义报文, PZD-30/10
西门子报文 111, PZD-12/12

订货号:

说明:
支持的固件版本为V02.05、V02.06及更高版本。
百川自定义报文: 定位包含 MDI, PZD 长度 30/10 字

8.3.4.3修改设备名称

工具 -> 查找 PROFINET 设备 ->选择相应网卡 -> 查找设备

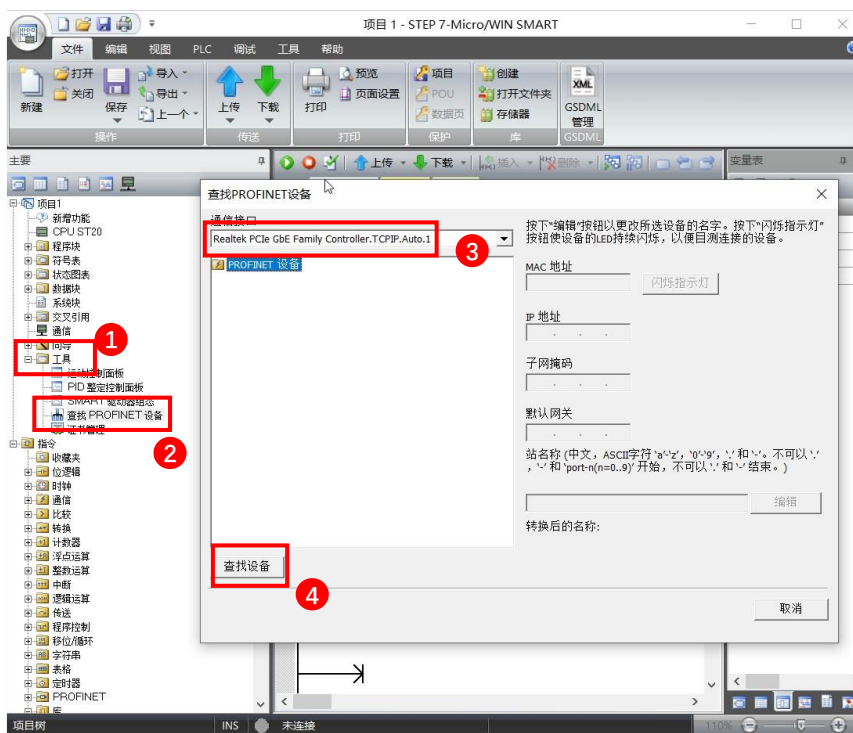

选择设备 -> 编辑设备名称

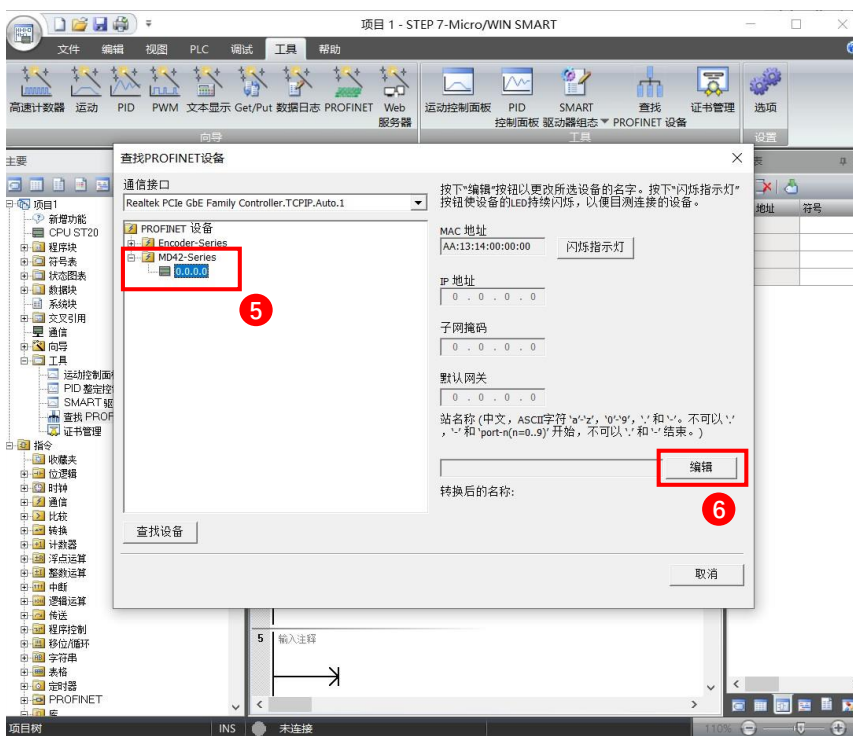

输入组态的名称 -> 设置

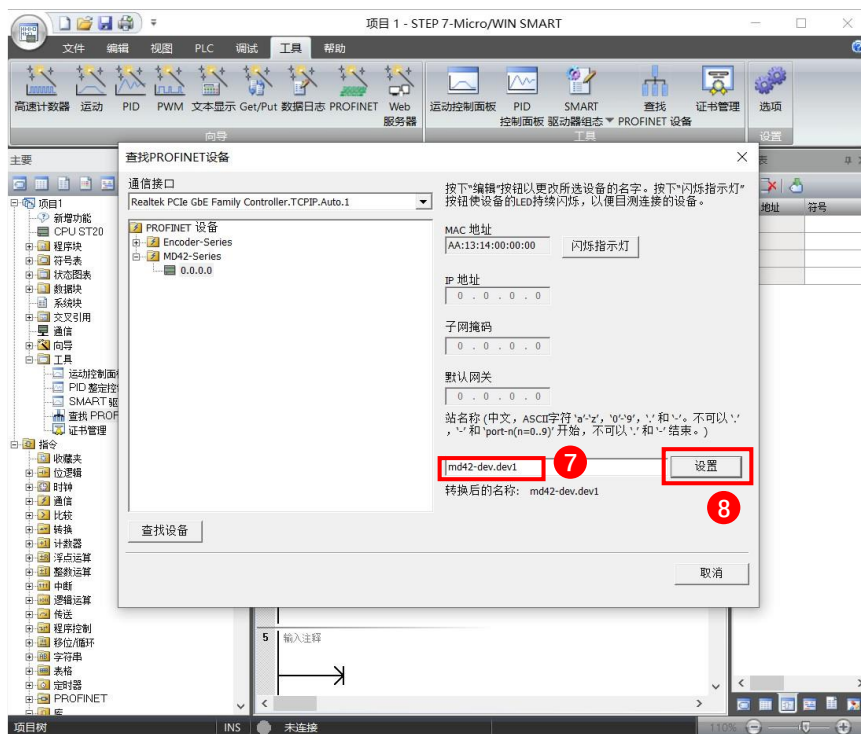

确认设置完成 -> 关闭窗口

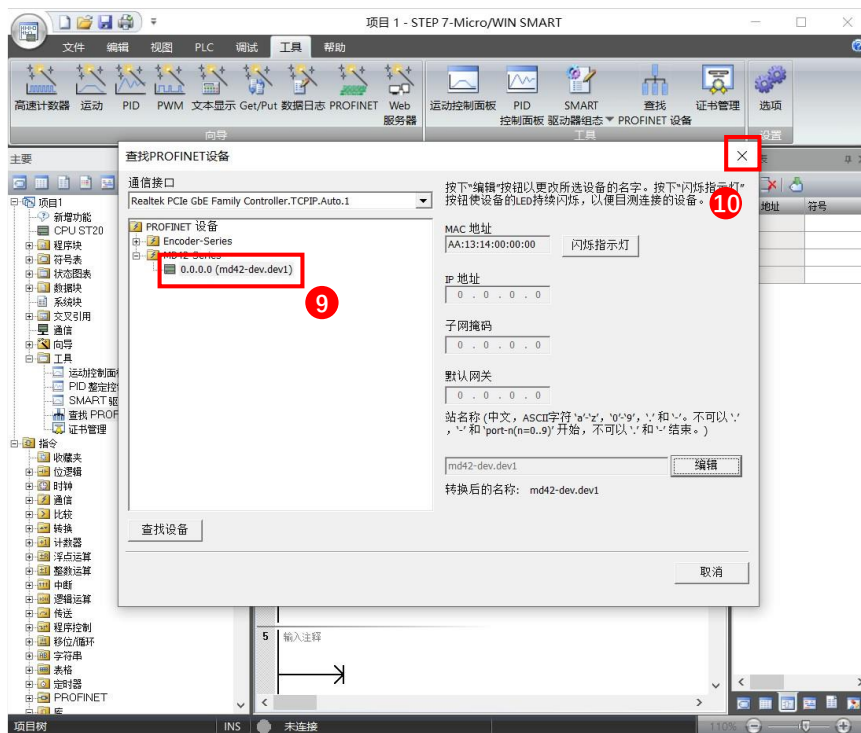

8.3.5 控制电机

8.3.5.1 控制方法

8.3.5.1.1 厂家报文使用方法

本样例为使用厂家报文进行控制提供一个库文件“BCMD_LIB.smartlib”，用户可添加库文件使用。



BCMD_LIB.
smartlib

库名称	特点	引脚
BCMD_LIB.smartlib	通过引脚控制电机。	<pre> MD_PN_CTRL ├── EN ├── ModePos ├── Position ├── Velocity ├── EnableAxis ├── CancelTra~ ├── Intermediat~ ├── ExecuteMo~ ├── St_I_add (&IB128) ├── St_Q_add (&QB128) ├── Control_ta~ (&VB12) ├── Status_table (&VB24) ├── ActVelocity → VD32 ├── ActPosition → VD36 ├── Warn_code → VW40 ├── Fault_code → VW42 ├── Done → V44.0 </pre>

8.3.5.1.1.1 导入库文件

右键“库”-> 打开库文件夹

此时会打开放置库的文件夹，路径为“...\\Siemens\\STEP 7-MicroWIN SMART\\Lib”

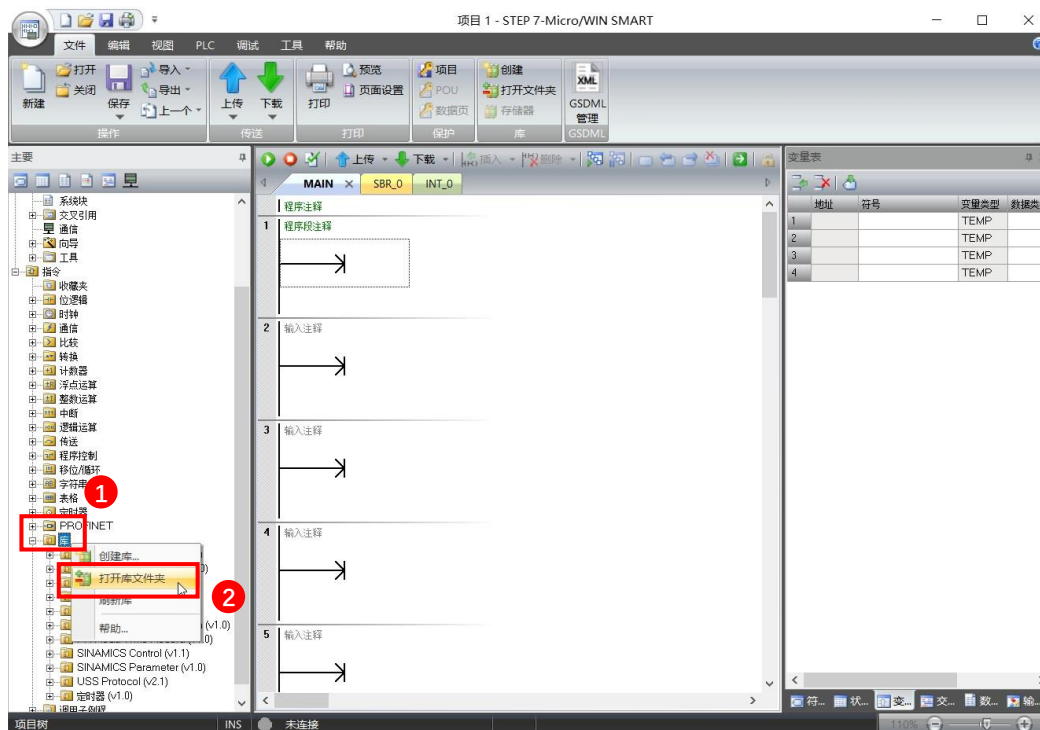

将库文件“BCMD_LIB.smartlib” 拷贝到打开的文件夹 Lib 内

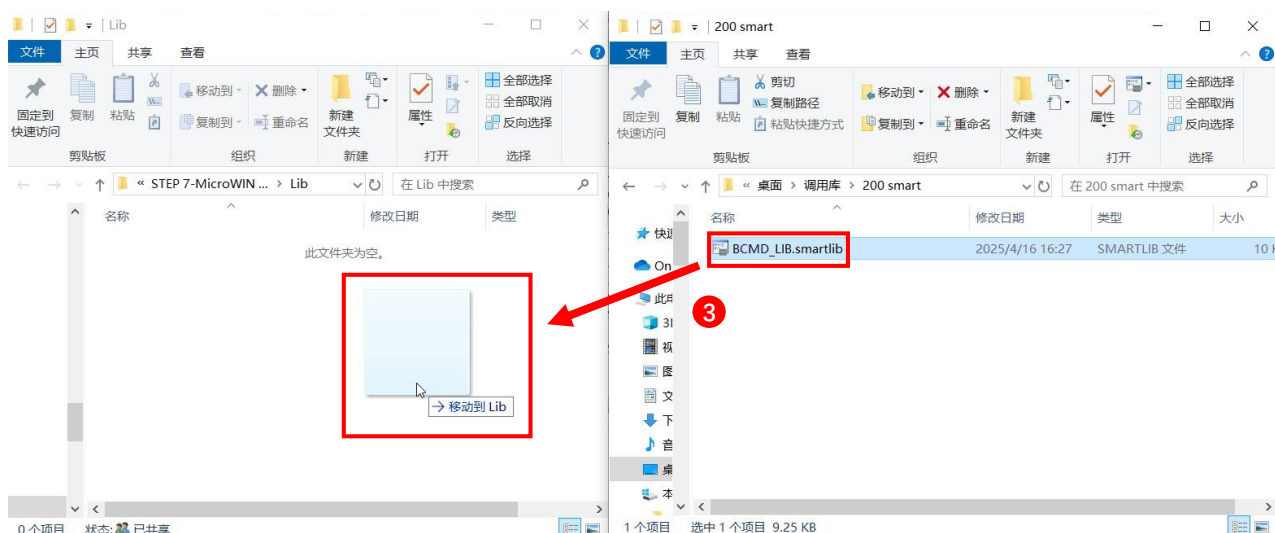

右键“库”->刷新库

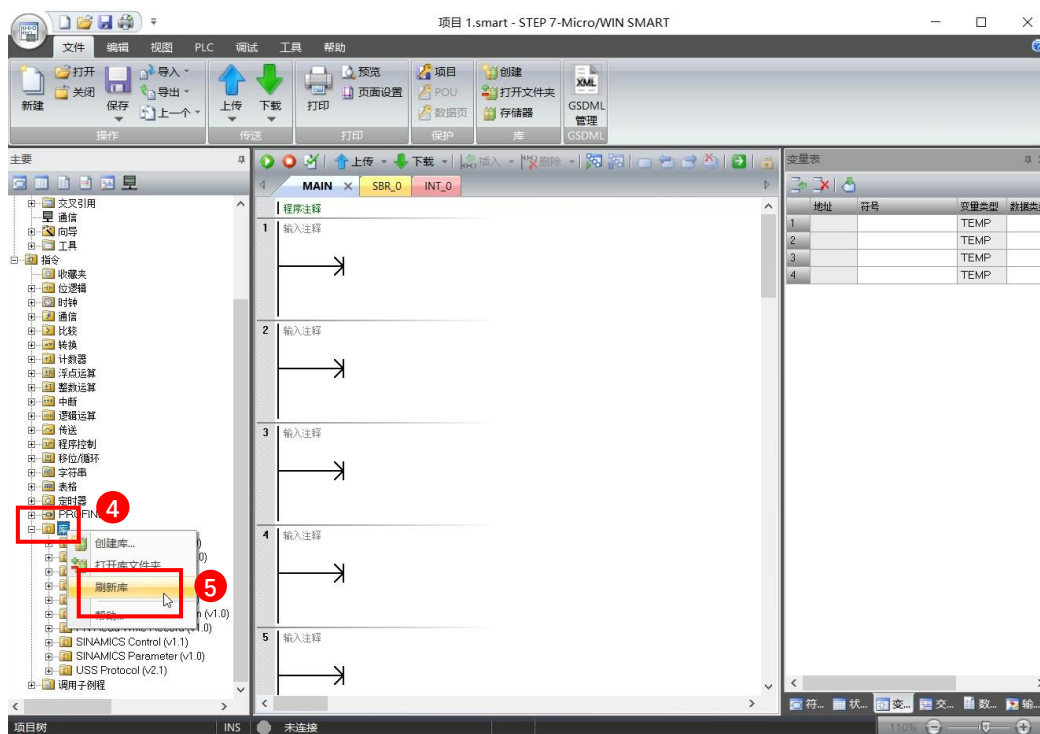

此时库列表中会出现 BCMD_PN_Control

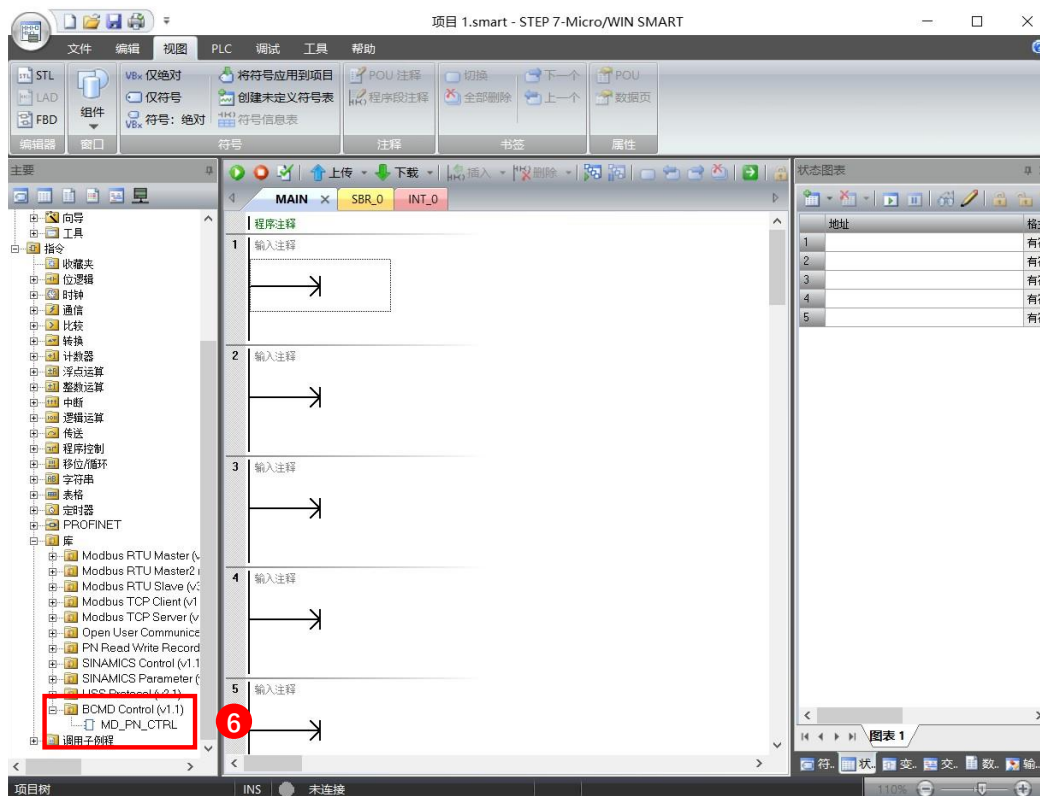

8.3.5.1.1.2 生成函数块

将库函数拖拽到程序段

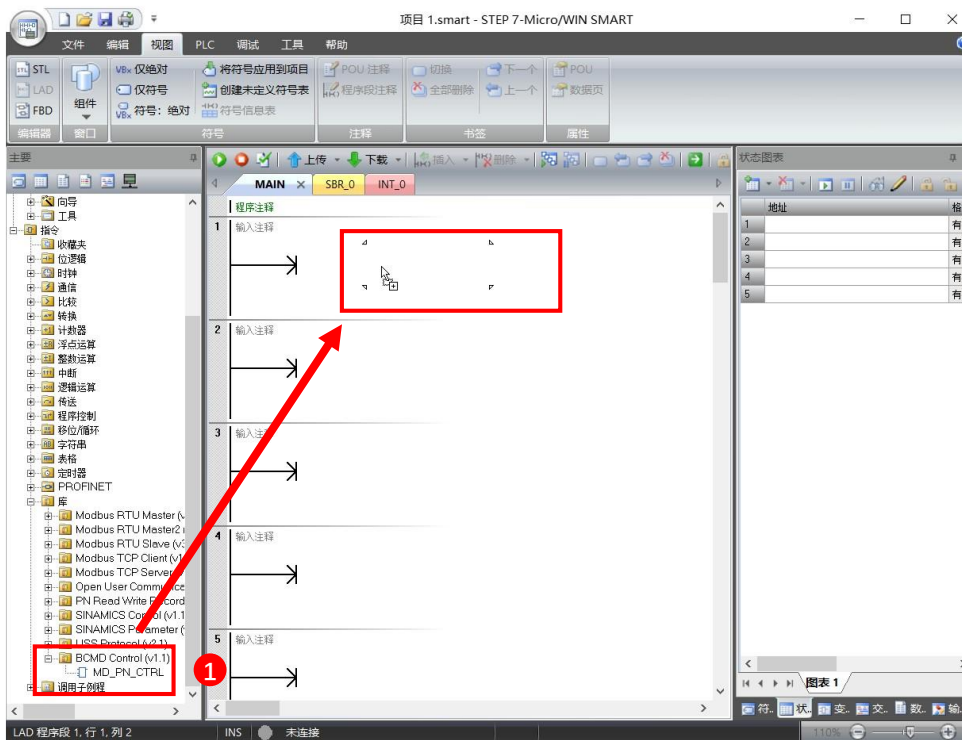

此时库函数已经添加到程序段内

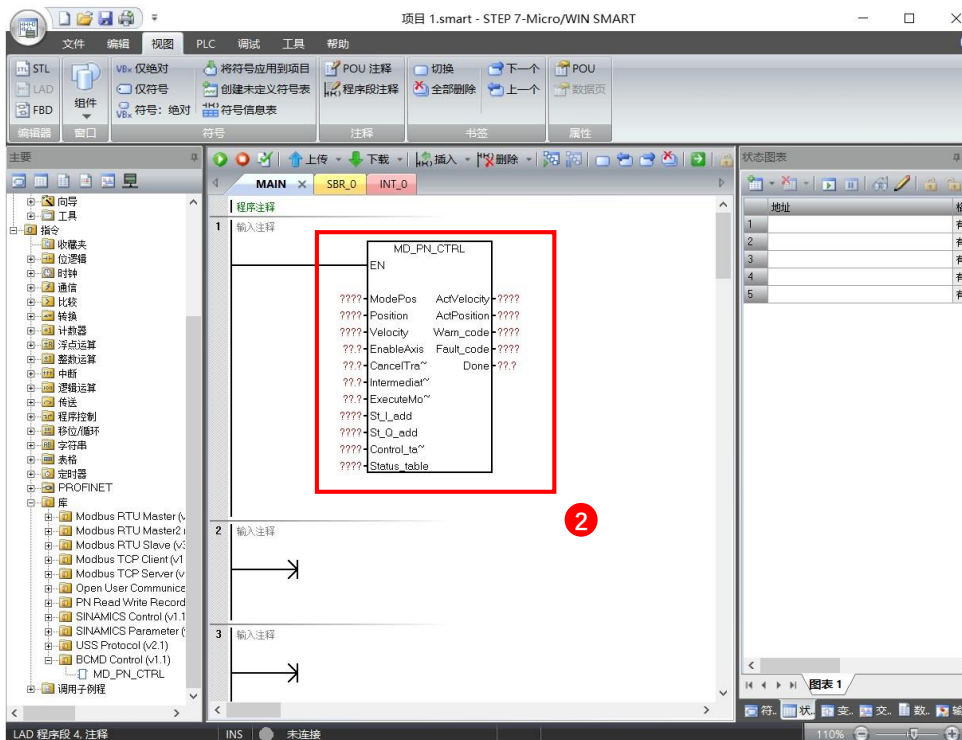

将控制变量填入引脚

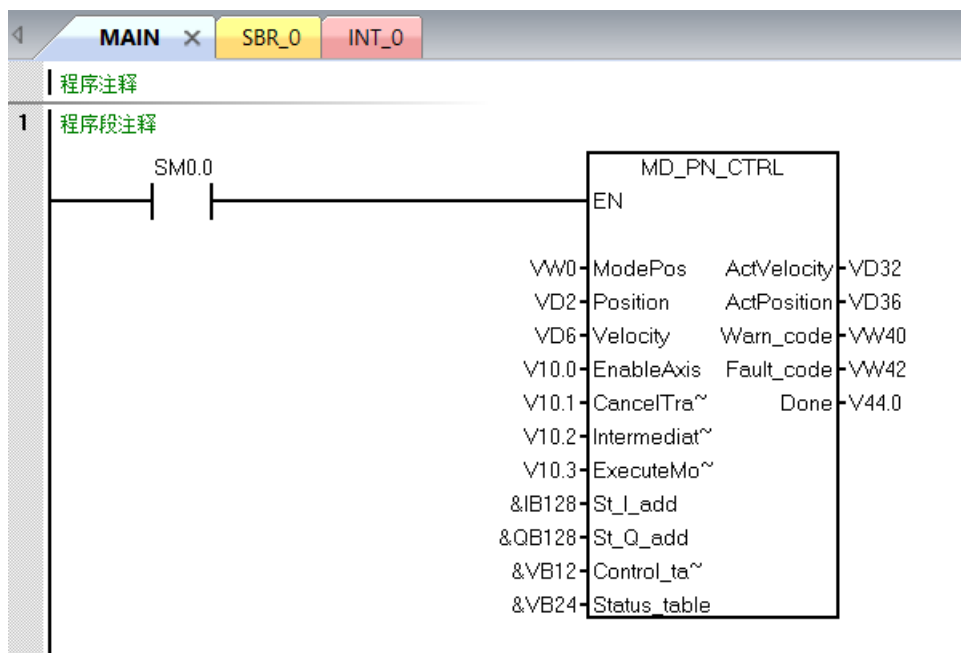

8.3.5.1.1.3 符号表分配

此步骤是将使用的变量添加符号，方便使用符号寻址。

符号	地址	注释
I_1ModePos	VW0	运动模式: 0失败, 1绝对位置, 2相对位置, 3速度, 4主动回零, 5零点设置, 6程序步, 7点动, 8寸动
I_2Position	VD2	设定位置 (lu)
I_3Velocity	VD6	设定速度 (lu/s)
I_4EnableAxis	V10.0	使能
I_5CancelTraversing	V10.1	取消任务: 0=取消当前的运行任务 1=不取消当前的运行任务
I_6IntermediateStop	V10.2	暂停任务: 0 = 暂停当前运行任务 1 = 不暂停当前运行任务
I_7ExecuteMode	V10.3	激活运行作业, 不要和轴使能在同一个PLC扫描周期内进行动作触发
I_8Control	VB12	控制表 12字节
I_9Status	VB24	状态表 8字节
O_1ActVelocity	VD32	当前速度
O_2ActPosition	VD36	当前位置
O_3Warn_code	VW40	电机状态
O_4Fault_code	VW42	MD_PN_CTRL块状态
O_5Done	V44.0	完成
Control_1Positive	V12.0	Positive正向旋转
Control_2Negative	V12.1	Negative负向旋转
Control_3JOG1	V12.2	点动1
Control_4JOG2	V12.3	点动2
Control_5AckError	V12.5	AckError(确认错误)
Control_6OverV	VW14	所有运行模式的速度倍率有效: 0-199%
Control_7OverAcc	VW16	加速度倍率有效: 0-100%
Control_8ConfigEpos	VD20	ConfigEpos>0.OFF2.X1.OFF3
Status1Axisenabled	V24.0	驱动已使能
Status2AxisPosOk	V24.1	达到轴的当前位置
Status3AxisRef	V24.2	已设置参考点
Status4AxisWarn	V24.4	驱动警告主警告
Status5AxisError	V24.5	驱动警告主错误
Status6OverrangeErr	V24.6	输入的数值超出范围

视图使用 “符号:绝对” 效果如下

程序注释

1 程序段注释

```

Always_On.SM0.0
├── MD_PN_CTRL
│   ├── EN
│   ├── ModePos: I_1ModePos:VW0
│   ├── Position: I_2Position:VD2
│   ├── Velocity: I_3Velocity:VD6
│   ├── EnableAxis: I_4EnableAxis:V10.0
│   ├── CancelTraversing: I_5CancelTraversing:V10.1
│   ├── IntermediateStop: I_6IntermediateStop:V10.2
│   ├── ExecuteMode: I_7ExecuteMode:V10.3
│   ├── St_I_add: &B128
│   ├── St_Q_add: &QB128
│   ├── Control_table: &I_8Control:&VB12
│   └── Status_table: &I_9Status:&VB24
│
│   ├── ActVelocity: O_1ActVelocity:VD32
│   ├── ActPosition: O_2ActPosition:VD36
│   ├── Warn_code: O_3Warn_code:VW40
│   ├── Fault_code: O_4Fault_code:VW42
│   └── Done: O_5Done:V44.0

```

符号	地址	注释
Always_On	SM0.0	始终接通
I_1ModePos	VW0	运动模式: 0失败, 1绝对位置, 2相对位置, 3速度, 4主动回零, 5零点设置, 6程序步, 7点动, 8寸动
I_2Position	VD2	设定位置 (lu)
I_3Velocity	VD6	设定速度 (lu/s)
I_4EnableAxis	V10.0	使能
I_5CancelTraversing	V10.1	取消任务: 0=取消当前的运行任务 1=不取消当前的运行任务
I_6IntermediateStop	V10.2	暂停任务: 0 = 暂停当前运行任务 1 = 不暂停当前运行任务
I_7ExecuteMode	V10.3	激活运行作业, 不要和轴使能在同一个PLC扫描周期内进行动作触发
I_8Control	VB12	控制表 12字节
I_9Status	VB24	状态表 8字节
O_1ActVelocity	VD32	当前速度
O_2ActPosition	VD36	当前位置
O_3Warn_code	VW40	电机状态
O_4Fault_code	VW42	MD_PN_CTRL块状态
O_5Done	V44.0	完成

8.3.5.1.1.4 库存储器分配

右键“库”->“库存储器”

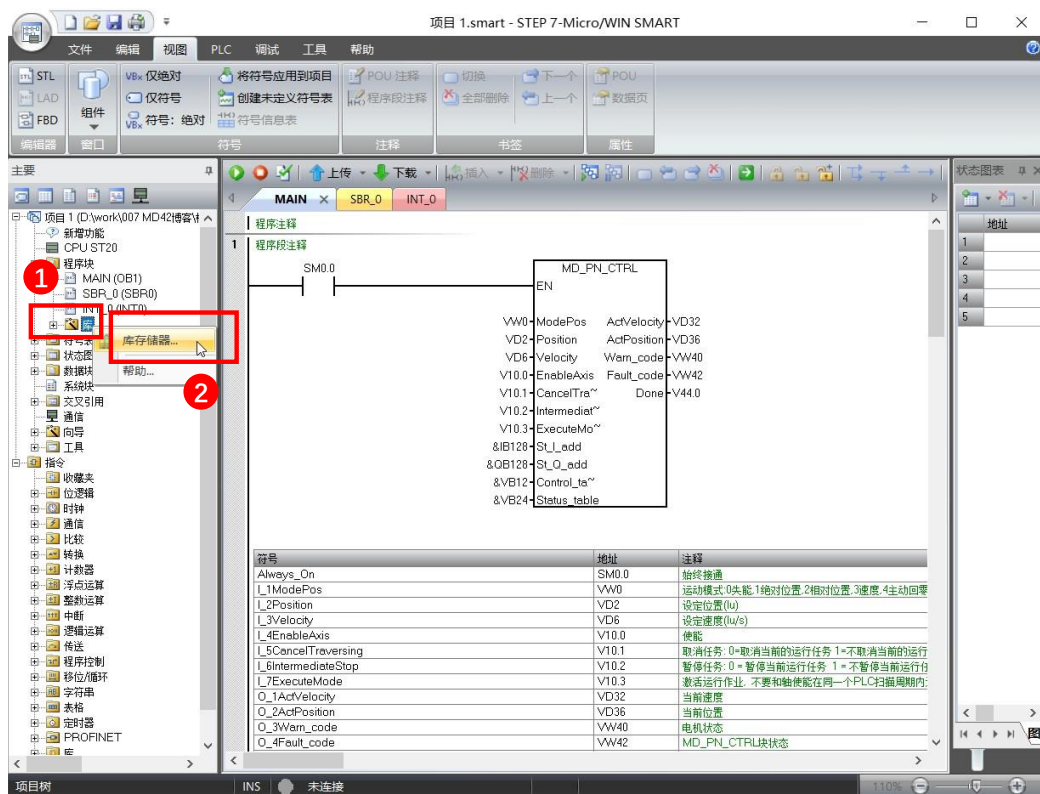

为 BCMD Control 分配未被使用的地址，可以使用建议地址分配，也可手动分配。

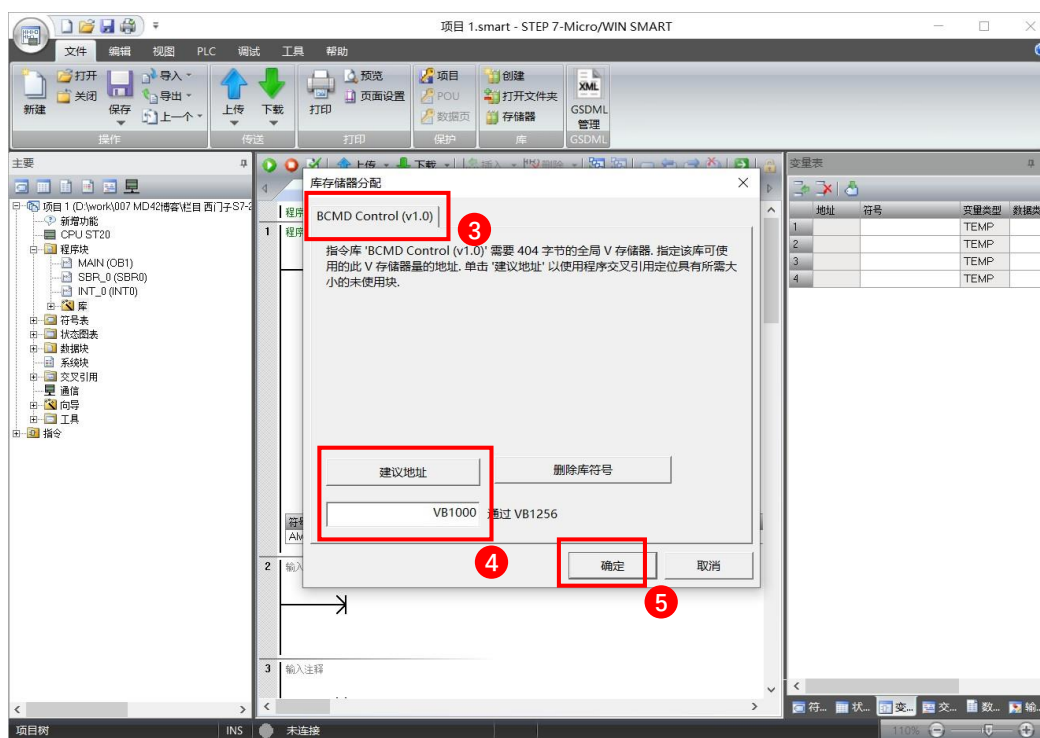

8.3.5.1.1.5 MD_PN_CTRL 函数块

8.3.5.1.1.5.1 块接口说明

8.3.5.1.1.5.1.1 输入接口

MD_PN_CTRL 的输入接口		
输入信号	类型	含义
ModePos	Int	运动模式: 1=相对位置模式 2=绝对位置模式 3=速度模式 4=主动回零模式 5=零点设置模式 6=程序步模式 7=点动模式 8=寸动模式
Position	DInt	设定位置(lu)
Velocity	DInt	设定速度(lu/s)
EnableAxis	Bool	轴使能
CancelTraversing	Bool	取消任务: 0=取消当前的运行任务 1=不取消当前的运行任务
IntermediateStop	Bool	暂停任务: 0 = 暂停当前运行任务 1 = 不暂停当前运行任务
ExecuteMode	Bool	激活运行作业,不能和轴使能在同一个 PLC 扫描周期内进行动作触发
St_I_add	DWORD	PROFINET IO I 存储区起始地址的指针。
St_Q_add	DWORD	PROFINET IO Q 存储区起始地址的指针。
Control_table	DWORD	控制表 Control_table 起始地址的指针。12 字节
Status_table	DWORD	状态表 Status_table 起始地址的指针。8 字节

8.3.5.1.1.5.1.2 输出接口

MD_PN_CTRL 的输出接口		
输出信号	类型	含义
ActVelocity	DInt	当前速度(经滤波的编码器值, 单位: lu/s)
ActPosition	DInt	当前位置(编码器值, 单位: lu)
Warn_code	Word	警告代码信息
Fault_code	Word	故障代码信息
Done	Bool	当操作模式为相对运动或绝对运动时达到目标位置

8.3.5.1.1.5.2 Control_table 定义

Control_table								
字节偏移	位 7	位 6	位 5	位 4	位 3	位 2	位 1	位 0
0	保留	保留	AckError 确认错误	保留	JOG2 点动 2	JOG1 点动 1	Negative 负向旋转	Positive 正向旋转
1	保留							
2	OverV: 所有运行模式的速度倍率有效: 0-199%							
3								
4	OverAcc: 加速度倍率有效 0-100%, 不适用于主动回零、点动及寸动模式							
5								
6	保留							
7								
8	ConfigEpos							
9								
10								
11								

ConfigEpos 位	功能说明
ConfigEpos.%X0	OFF2 (1 = 无脉冲禁用)
ConfigEpos.%X1	OFF3 (1 = 无斜坡停止)
ConfigEpos.%X2	激活软限位功能(零点设置后生效)
ConfigEpos.%X3	激活硬限位功能(与调试软件中启用硬限位功能互为“或”逻辑, 两者满足其一即生效)
ConfigEpos.%X6	零点开关信号
ConfigEpos.%X8	设定值连续传输 (绝对位置模式、速度模式下有效) 0=单步传输 (通过<启动任务>上升沿接收新的设定值) 1=连续传输 (立即接收新的设定值)

注意: 当程序中对 ConfigEpos 的相关位变量进行配置时, 必须将其初始值设置为 3 (ConfigEpos.%X0 = 1, ConfigEpos.%X1 = 1), 以确保 OFF2 和 OFF3 停止功能处于非禁用与停止状态。

8.3.5.1.1.5.3 Status_table 定义

Status_table								
字节偏移	位 7	位 6	位 5	位 4	位 3	位 2	位 1	位 0
0	保留	Overrange_Error 输入的数据超出范围	AxisError 驱动器发生错误	AxisWarn 驱动器发生警告	Lockout 驱动器禁止接通	AxisRef 已设置参考点	AxisPosOk 达到轴的目标位置	Axisenabled 驱动已使能
1	ErrorID:错误							
2	Actmode:当前激活的运行模式							
3								
4	POS_ZSW1:POS ZSW1 状态字							
5								
6	POS_ZSW2:POS ZSW2 状态字							
7								

错误代码	说明
0	无错误
1	检测到驱动器错误
2	驱动器已禁用
3	不支持所选模式
4	参数 OverV、OverAcc、OverDec 的设置超出支持的取值范围
5	ModePos=6 时，设置的程序段号超出范围

8.3.5.1.1.5.4 关联控制对象

必要参数设定	
步骤	图示
<p>1、确认控制对象 IO 映射区。 查看你要控制的设备的 IO 映射区。 详细可见：查看信息 图示中为 I 区域：IB128~IB188 Q 区域：QB128~QB148</p>	

2、填入输入输出地址指针

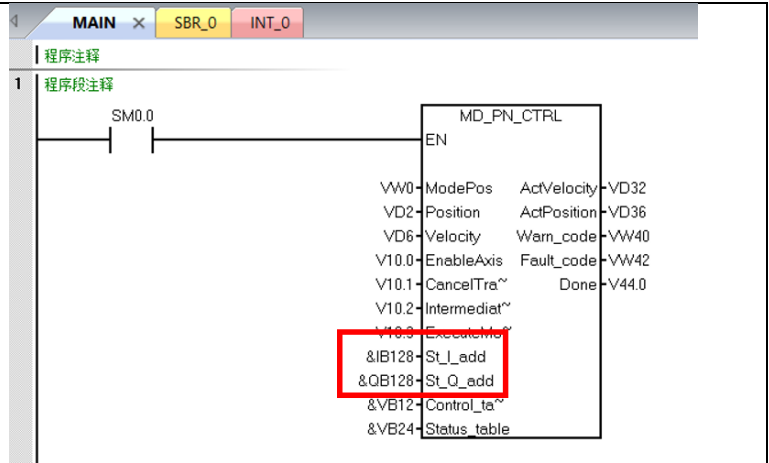

8.3.5.1.1.5.5 函数块控制

以下样例在于分别演示各个运动模式的操作顺序，部分步骤(如速度倍率、加速度倍率等)不需要每次运动都设定，步骤仅供参考，用户需要根据实际情况进行修改。

8.3.5.1.1.5.5.1 相对定位模式

相对位置模式	
步骤	图示
1、ModePos = 1 运动模式切换到相对位置模式。	
2、CancelTraversing = TRUE 让设备不暂停任务。	
3、IntermediateStop = TRUE 让设备不取消任务。	
4、Position = 5000 确定相对位置移动的距离，单位为 lu。	
5、Velocity = 5000 确定相对位置移动的速度，单位为 lu/s。	
6、OverV = 100 速度倍率设定，所有运行模式的速度倍率，值范围：0-199(%)	
7、OverAcc = 100 加速度倍率设定，值范围：0-100(%)，不适用于主动回零、点动及寸动模式	
8、OFF2、OFF3 都设置为 1 Control_table 中的 ConfigEpos 的 X0(OFF2),X1(OFF3)设定为 1。	
9、EnableAxis=1 让电机使能。	
10、等待时间 X 确保参数传输完毕，X 应大于 2 倍 IO 周期时间。IO 周期时间参考 查看信息	
11、ExecuteMode = TRUE 该信号上升沿时启动任务,设备按照设定的位置和速度执行相对位置运动。	

符号分配详细见[符号表分配](#)

8.3.5.1.1.5.5.2 绝对定位模式

绝对位置模式	
步骤	图示
1、ModePos = 2 运动模式切换到绝对位置模式。 (该模式需要先设定零点)	<p>输入注释 M01启动绝对: M0.1 L7ExecuteM: V10.3</p>
2、CancelTraversing = TRUE 让设备不暂停任务。	
3、IntermediateStop = TRUE 让设备不取消任务。	
4、Position = 5000 确定绝对位置移动的位置，单位为 lu。	
5、Velocity = 5000 确定绝对位置移动的速度，单位为 lu/s。	
6、OverV = 100 速度倍率设定，所有运行模式的速度倍率，值范围：0-199(%)	
7、OverAcc = 100 加速度倍率设定，值范围：0-100(%)，不适用于主动回零、点动及寸动模式	
8、OFF2、OFF3 都设置为 TRUE Control_table 中的 ConfigEpos 的 X0(OFF2),X1(OFF3)设定为 1。	
9、EnableAxis=1 让电机使能。	
10、等待时间 X 确保参数传输完毕，X 应大于 2 倍数据周期时间。IO 周期时间参考 查看信息	
11、ExecuteMode = TRUE 该信号上升沿时启动任务,设备按照设定的位置和速度执行绝对位置运动。	

符号分配详细见[符号表分配](#)

8.3.5.1.1.5.5.3 速度模式

速度模式	
步骤	图示
1、ModePos = 3 运动模式切换到速度模式。	<p>输入注释 M02自动速* M0.2 L7ExecuteM V10.3</p>
2、CancelTraversing = TRUE 让设备不暂停任务。	
3、IntermediateStop = TRUE 让设备不取消任务。	
4、Velocity = 5000 确定速度模式移动的速度，单位为 lu/s。	
5、Positive = TRUE 确认旋转方向为正方向。	
6、OverV = 100 速度倍率设定，所有运行模式的速度倍率，值范围：0-199(%)	
7、OverAcc = 100 加速度倍率设定，值范围：0-100(%)，不适用于主动回零、点动及寸动模式	
8、OFF2、OFF3 都设置为 TRUE Control_table 中的 ConfigEpos 的 X0(OFF2),X1(OFF3)设定为 1。	
9、EnableAxis=1 让电机使能。	
10、等待时间 X 确保参数传输完毕，X 应大于 2 倍数据周期时间。 IO 周期时间参考 查看信息	
11、ExecuteMode = TRUE 该信号上升沿时启动任务,设备按照设定的速度执行速度模式运动。	

符号分配详见[符号表分配](#)

8.3.5.1.1.5.5.4 主动回零模式

8.3.5.1.1.5.5.4.1 扭矩回零

主动回零模式-使用扭矩回零方式	
步骤	图示
<p>1、参数 limit_protect_enable = 0 关闭硬限位功能。</p>	
<p>2、参数 homing_method = 0 使用扭矩回零。</p>	
<p>3、参数 homing_use_z_signal = 0 关闭 z 信号辅助回零。</p>	
<p>4、参数 homing_torque_threshold = 98 扭矩回零阈值设置为 98%。</p>	
<p>5、ModePos = 4 运动模式切换到主动回零模式。</p>	
<p>6、CancelTraversing = TRUE 让设备不暂停任务。</p>	
<p>7、IntermediateStop = TRUE 让设备不取消任务。</p>	
<p>8、OverV = 100 速度倍率设定，所有运行模式的速度倍率，值范围：0-199(%)</p>	
<p>9、OverAcc = 100 加速度倍率设定，值范围：0-100(%)，不适用于主动回零、点动及寸动模式</p>	
<p>10、OFF2、OFF3 都设置为 TRUE Control_table 中的 ConfigEpos 的 X0(OFF2),X1(OFF3)设定为 1。</p>	
<p>11、EnableAxis=1 让电机使能。</p>	
<p>12、等待时间 X 确保参数传输完毕，X 应大于 2 倍数据周期时间。 IO 周期时间参考 查看信息</p>	
<p>13、ExecuteMode = TRUE 该信号上升沿时启动任务,设备按照参数表设定的回零参数执行主动回零。</p>	

符号分配详见[符号表分配](#)

8.3.5.1.1.5.5.4.2 扭矩回零+编码器 z 信号

主动回零模式-使用扭矩回零方式+编码器 z 信号	
步骤	图示
1、参数 limit_protect_enable = 0 关闭硬限位功能。	
2、参数 homing_method = 0 使用扭矩回零。	
3、参数 homing_use_z_signal = 1 开启 z 信号辅助回零。	
4、参数 homing_torque_threshold = 98 扭矩回零阈值设置为 98%。	
5、ModePos = 4 运动模式切换到主动回零模式。	
6、CancelTraversing = TRUE 让设备不暂停任务。	
7、IntermediateStop = TRUE 让设备不取消任务。	
8、OverV = 100 速度倍率设定，所有运行模式的速度倍率，值范围：0-199(%)	
9、OverAcc = 100 加速度倍率设定，值范围：0-100(%)，不适用于主动回零、点动及寸动模式	
10、OFF2、OFF3 都设置为 TRUE Control_table 中的 ConfigEpos 的 X0(OFF2),X1(OFF3)设定为 1。	
11、EnableAxis=1 让电机使能。	
12、等待时间 X 确保参数传输完毕，X 应大于 2 倍数据周期时间。 IO 周期时间参考 查看信息	
13、ExecuteMode = TRUE 该信号上升沿时启动任务,设备按照参数表设定的回零参数执行主动回零。	

符号分配详见[符号表分配](#)

8.3.5.1.1.5.5.4.3 硬限位回零

主动回零模式-使用硬限位信号方式																																																																																																																																																																																																																																																																																																																																																																																																																																																																																																																																																																																																																																																																																																																																																																																																																																																																																																																																																																																																																																																																																																																																																																																																																																																																																																																																																					
步骤	图示																																																																																																																																																																																																																																																																																																																																																																																																																																																																																																																																																																																																																																																																																																																																																																																																																																																																																																																																																																																																																																																																																																																																																																																																																																																																																																																																																				
1、参数 limit_protect_enable = 1 使能硬限位功能。	<table border="1"> <thead> <tr> <th>参数号</th> <th>参数名称</th> <th>参数名</th> <th>描述</th> <th>设置值</th> <th>当前值</th> <th>出厂值</th> <th>最小值</th> <th>最大值</th> <th>单位</th> </tr> </thead> <tbody> <tr><td>42</td><td>限位参数</td><td>target_maxhd_shrshld</td><td>位置禁止限值</td><td>-10</td><td>-10</td><td>-10</td><td>-10</td><td>16</td><td>2°/s</td></tr> <tr><td>43</td><td>限位参数</td><td>target_maxhd_shrshld</td><td>位置禁止限值</td><td>10</td><td>10</td><td>10</td><td>10</td><td>16</td><td>mm</td></tr> <tr><td>44</td><td>限位参数</td><td>velocity_maxhd_shrshld</td><td>速度禁止限值</td><td>10</td><td>10</td><td>10</td><td>1</td><td>6000</td><td>rpm</td></tr> <tr><td>45</td><td>限位参数</td><td>velocity_maxhd_shrshld</td><td>速度禁止限值</td><td>10</td><td>10</td><td>10</td><td>1</td><td>6000</td><td>mm</td></tr> <tr><td>70</td><td>限位参数</td><td>absShld_Shrshld</td><td>零速检测</td><td>2</td><td>2</td><td>2</td><td>1</td><td>6000</td><td>rpm</td></tr> <tr><td>71</td><td>限位参数</td><td>absShld_Shrshld</td><td>零速检测</td><td>10</td><td>10</td><td>10</td><td>1</td><td>6000</td><td>mm</td></tr> <tr><td>74</td><td>保护中间参数</td><td>following_error_maxdeviating_makda</td><td>跟踪误差最大值</td><td>0</td><td>0</td><td>0</td><td>0</td><td>1</td><td>mm</td></tr> <tr><td>75</td><td>保护中间参数</td><td>following_error_maxdeviating_makda</td><td>跟踪误差最大值</td><td>-4</td><td>-4</td><td>-4</td><td>-10</td><td>16</td><td>2°/s</td></tr> <tr><td>76</td><td>保护中间参数</td><td>following_error_shrshld</td><td>跟踪误差限值</td><td>-2</td><td>-2</td><td>-2</td><td>-10</td><td>16</td><td>mm</td></tr> <tr><td>77</td><td>保护中间参数</td><td>following_error_shrshld</td><td>跟踪误差限值</td><td>200</td><td>200</td><td>200</td><td>0</td><td>1</td><td>mm</td></tr> <tr><td>82</td><td>保护中间参数</td><td>stop_prntnc_velocity_maxshld</td><td>轴停止速度限值</td><td>0</td><td>0</td><td>0</td><td>0</td><td>1</td><td>rpm</td></tr> <tr><td>83</td><td>保护中间参数</td><td>stop_prntnc_velocity_maxshld</td><td>轴停止速度限值</td><td>2</td><td>2</td><td>2</td><td>1</td><td>6000</td><td>rpm</td></tr> <tr><td>84</td><td>保护中间参数</td><td>stop_prntnc_velocity_maxshld</td><td>轴停止速度限值</td><td>100</td><td>100</td><td>100</td><td>1</td><td>100</td><td>%</td></tr> <tr><td>85</td><td>保护中间参数</td><td>stop_prntnc_velocity_maxshld</td><td>轴停止速度限值</td><td>200</td><td>200</td><td>200</td><td>2</td><td>1</td><td>mm</td></tr> <tr><td>86</td><td>保护中间参数</td><td>stop_prntnc_velocity_maxshld</td><td>轴停止速度限值</td><td>1</td><td>1</td><td>1</td><td>0</td><td>1</td><td>mm</td></tr> <tr><td>87</td><td>保护中间参数</td><td>stop_prntnc_velocity_maxshld</td><td>轴停止速度限值</td><td>0</td><td>0</td><td>0</td><td>0</td><td>1</td><td>mm</td></tr> <tr><td>88</td><td>保护中间参数</td><td>stop_prntnc_velocity_maxshld</td><td>轴停止速度限值</td><td>0</td><td>0</td><td>0</td><td>0</td><td>1</td><td>mm</td></tr> <tr><td>89</td><td>保护中间参数</td><td>stop_prntnc_velocity_maxshld</td><td>轴停止速度限值</td><td>0</td><td>0</td><td>0</td><td>0</td><td>1</td><td>mm</td></tr> <tr><td>90</td><td>保护中间参数</td><td>stop_prntnc_velocity_maxshld</td><td>轴停止速度限值</td><td>0</td><td>0</td><td>0</td><td>0</td><td>1</td><td>mm</td></tr> <tr><td>91</td><td>保护中间参数</td><td>stop_prntnc_velocity_maxshld</td><td>轴停止速度限值</td><td>0</td><td>0</td><td>0</td><td>0</td><td>1</td><td>mm</td></tr> <tr><td>92</td><td>保护中间参数</td><td>stop_prntnc_velocity_maxshld</td><td>轴停止速度限值</td><td>0</td><td>0</td><td>0</td><td>0</td><td>1</td><td>mm</td></tr> <tr><td>93</td><td>保护中间参数</td><td>stop_prntnc_velocity_maxshld</td><td>轴停止速度限值</td><td>0</td><td>0</td><td>0</td><td>0</td><td>1</td><td>mm</td></tr> <tr><td>94</td><td>保护中间参数</td><td>stop_prntnc_velocity_maxshld</td><td>轴停止速度限值</td><td>0</td><td>0</td><td>0</td><td>0</td><td>1</td><td>mm</td></tr> <tr><td>95</td><td>保护中间参数</td><td>stop_prntnc_velocity_maxshld</td><td>轴停止速度限值</td><td>0</td><td>0</td><td>0</td><td>0</td><td>1</td><td>mm</td></tr> <tr><td>96</td><td>保护中间参数</td><td>stop_prntnc_velocity_maxshld</td><td>轴停止速度限值</td><td>0</td><td>0</td><td>0</td><td>0</td><td>1</td><td>mm</td></tr> <tr><td>97</td><td>保护中间参数</td><td>stop_prntnc_velocity_maxshld</td><td>轴停止速度限值</td><td>0</td><td>0</td><td>0</td><td>0</td><td>1</td><td>mm</td></tr> <tr><td>98</td><td>保护中间参数</td><td>stop_prntnc_velocity_maxshld</td><td>轴停止速度限值</td><td>0</td><td>0</td><td>0</td><td>0</td><td>1</td><td>mm</td></tr> <tr><td>99</td><td>保护中间参数</td><td>stop_prntnc_velocity_maxshld</td><td>轴停止速度限值</td><td>0</td><td>0</td><td>0</td><td>0</td><td>1</td><td>mm</td></tr> <tr><td>100</td><td>保护中间参数</td><td>stop_prntnc_velocity_maxshld</td><td>轴停止速度限值</td><td>0</td><td>0</td><td>0</td><td>0</td><td>1</td><td>mm</td></tr> <tr><td>101</td><td>保护中间参数</td><td>stop_prntnc_velocity_maxshld</td><td>轴停止速度限值</td><td>0</td><td>0</td><td>0</td><td>0</td><td>1</td><td>mm</td></tr> <tr><td>102</td><td>保护中间参数</td><td>stop_prntnc_velocity_maxshld</td><td>轴停止速度限值</td><td>0</td><td>0</td><td>0</td><td>0</td><td>1</td><td>mm</td></tr> <tr><td>103</td><td>保护中间参数</td><td>stop_prntnc_velocity_maxshld</td><td>轴停止速度限值</td><td>0</td><td>0</td><td>0</td><td>0</td><td>1</td><td>mm</td></tr> <tr><td>104</td><td>回零参数</td><td>homing_method</td><td>回零方法</td><td>1</td><td>1</td><td>1</td><td>0</td><td>1</td><td>mm</td></tr> <tr><td>105</td><td>回零参数</td><td>homing_method</td><td>回零方法</td><td>0</td><td>0</td><td>0</td><td>0</td><td>1</td><td>mm</td></tr> <tr><td>106</td><td>回零参数</td><td>homing_use_z_signal</td><td>是否使用z信号</td><td>0</td><td>0</td><td>0</td><td>0</td><td>1</td><td>mm</td></tr> <tr><td>107</td><td>回零参数</td><td>homing_use_z_signal</td><td>是否使用z信号</td><td>1</td><td>1</td><td>1</td><td>0</td><td>1</td><td>mm</td></tr> <tr><td>108</td><td>回零参数</td><td>homing_use_z_signal</td><td>是否使用z信号</td><td>0</td><td>0</td><td>0</td><td>0</td><td>1</td><td>mm</td></tr> <tr><td>109</td><td>回零参数</td><td>homing_use_z_signal</td><td>是否使用z信号</td><td>0</td><td>0</td><td>0</td><td>0</td><td>1</td><td>mm</td></tr> <tr><td>110</td><td>回零参数</td><td>homing_use_z_signal</td><td>是否使用z信号</td><td>0</td><td>0</td><td>0</td><td>0</td><td>1</td><td>mm</td></tr> <tr><td>111</td><td>回零参数</td><td>homing_use_z_signal</td><td>是否使用z信号</td><td>0</td><td>0</td><td>0</td><td>0</td><td>1</td><td>mm</td></tr> <tr><td>112</td><td>回零参数</td><td>homing_use_z_signal</td><td>是否使用z信号</td><td>0</td><td>0</td><td>0</td><td>0</td><td>1</td><td>mm</td></tr> <tr><td>113</td><td>回零参数</td><td>homing_use_z_signal</td><td>是否使用z信号</td><td>0</td><td>0</td><td>0</td><td>0</td><td>1</td><td>mm</td></tr> <tr><td>114</td><td>回零参数</td><td>homing_use_z_signal</td><td>是否使用z信号</td><td>0</td><td>0</td><td>0</td><td>0</td><td>1</td><td>mm</td></tr> <tr><td>115</td><td>回零参数</td><td>homing_use_z_signal</td><td>是否使用z信号</td><td>0</td><td>0</td><td>0</td><td>0</td><td>1</td><td>mm</td></tr> <tr><td>116</td><td>回零参数</td><td>homing_use_z_signal</td><td>是否使用z信号</td><td>0</td><td>0</td><td>0</td><td>0</td><td>1</td><td>mm</td></tr> <tr><td>117</td><td>回零参数</td><td>homing_use_z_signal</td><td>是否使用z信号</td><td>0</td><td>0</td><td>0</td><td>0</td><td>1</td><td>mm</td></tr> <tr><td>118</td><td>回零参数</td><td>homing_use_z_signal</td><td>是否使用z信号</td><td>0</td><td>0</td><td>0</td><td>0</td><td>1</td><td>mm</td></tr> <tr><td>119</td><td>回零参数</td><td>homing_use_z_signal</td><td>是否使用z信号</td><td>0</td><td>0</td><td>0</td><td>0</td><td>1</td><td>mm</td></tr> <tr><td>120</td><td>回零参数</td><td>homing_use_z_signal</td><td>是否使用z信号</td><td>0</td><td>0</td><td>0</td><td>0</td><td>1</td><td>mm</td></tr> <tr><td>121</td><td>回零参数</td><td>homing_use_z_signal</td><td>是否使用z信号</td><td>0</td><td>0</td><td>0</td><td>0</td><td>1</td><td>mm</td></tr> <tr><td>122</td><td>回零参数</td><td>homing_use_z_signal</td><td>是否使用z信号</td><td>0</td><td>0</td><td>0</td><td>0</td><td>1</td><td>mm</td></tr> <tr><td>123</td><td>回零参数</td><td>homing_use_z_signal</td><td>是否使用z信号</td><td>0</td><td>0</td><td>0</td><td>0</td><td>1</td><td>mm</td></tr> <tr><td>124</td><td>回零参数</td><td>homing_use_z_signal</td><td>是否使用z信号</td><td>0</td><td>0</td><td>0</td><td>0</td><td>1</td><td>mm</td></tr> <tr><td>125</td><td>回零参数</td><td>homing_use_z_signal</td><td>是否使用z信号</td><td>0</td><td>0</td><td>0</td><td>0</td><td>1</td><td>mm</td></tr> <tr><td>126</td><td>回零参数</td><td>homing_use_z_signal</td><td>是否使用z信号</td><td>0</td><td>0</td><td>0</td><td>0</td><td>1</td><td>mm</td></tr> <tr><td>127</td><td>回零参数</td><td>homing_use_z_signal</td><td>是否使用z信号</td><td>0</td><td>0</td><td>0</td><td>0</td><td>1</td><td>mm</td></tr> <tr><td>128</td><td>回零参数</td><td>homing_use_z_signal</td><td>是否使用z信号</td><td>0</td><td>0</td><td>0</td><td>0</td><td>1</td><td>mm</td></tr> <tr><td>129</td><td>回零参数</td><td>homing_use_z_signal</td><td>是否使用z信号</td><td>0</td><td>0</td><td>0</td><td>0</td><td>1</td><td>mm</td></tr> <tr><td>130</td><td>回零参数</td><td>homing_use_z_signal</td><td>是否使用z信号</td><td>0</td><td>0</td><td>0</td><td>0</td><td>1</td><td>mm</td></tr> <tr><td>131</td><td>回零参数</td><td>homing_use_z_signal</td><td>是否使用z信号</td><td>0</td><td>0</td><td>0</td><td>0</td><td>1</td><td>mm</td></tr> <tr><td>132</td><td>回零参数</td><td>homing_use_z_signal</td><td>是否使用z信号</td><td>0</td><td>0</td><td>0</td><td>0</td><td>1</td><td>mm</td></tr> <tr><td>133</td><td>回零参数</td><td>homing_use_z_signal</td><td>是否使用z信号</td><td>0</td><td>0</td><td>0</td><td>0</td><td>1</td><td>mm</td></tr> <tr><td>134</td><td>回零参数</td><td>homing_use_z_signal</td><td>是否使用z信号</td><td>0</td><td>0</td><td>0</td><td>0</td><td>1</td><td>mm</td></tr> <tr><td>135</td><td>回零参数</td><td>homing_use_z_signal</td><td>是否使用z信号</td><td>0</td><td>0</td><td>0</td><td>0</td><td>1</td><td>mm</td></tr> <tr><td>136</td><td>回零参数</td><td>homing_use_z_signal</td><td>是否使用z信号</td><td>0</td><td>0</td><td>0</td><td>0</td><td>1</td><td>mm</td></tr> <tr><td>137</td><td>回零参数</td><td>homing_use_z_signal</td><td>是否使用z信号</td><td>0</td><td>0</td><td>0</td><td>0</td><td>1</td><td>mm</td></tr> <tr><td>138</td><td>回零参数</td><td>homing_use_z_signal</td><td>是否使用z信号</td><td>0</td><td>0</td><td>0</td><td>0</td><td>1</td><td>mm</td></tr> <tr><td>139</td><td>回零参数</td><td>homing_use_z_signal</td><td>是否使用z信号</td><td>0</td><td>0</td><td>0</td><td>0</td><td>1</td><td>mm</td></tr> <tr><td>140</td><td>回零参数</td><td>homing_use_z_signal</td><td>是否使用z信号</td><td>0</td><td>0</td><td>0</td><td>0</td><td>1</td><td>mm</td></tr> <tr><td>141</td><td>回零参数</td><td>homing_use_z_signal</td><td>是否使用z信号</td><td>0</td><td>0</td><td>0</td><td>0</td><td>1</td><td>mm</td></tr> <tr><td>142</td><td>回零参数</td><td>homing_use_z_signal</td><td>是否使用z信号</td><td>0</td><td>0</td><td>0</td><td>0</td><td>1</td><td>mm</td></tr> <tr><td>143</td><td>回零参数</td><td>homing_use_z_signal</td><td>是否使用z信号</td><td>0</td><td>0</td><td>0</td><td>0</td><td>1</td><td>mm</td></tr> <tr><td>144</td><td>回零参数</td><td>homing_use_z_signal</td><td>是否使用z信号</td><td>0</td><td>0</td><td>0</td><td>0</td><td>1</td><td>mm</td></tr> <tr><td>145</td><td>回零参数</td><td>homing_use_z_signal</td><td>是否使用z信号</td><td>0</td><td>0</td><td>0</td><td>0</td><td>1</td><td>mm</td></tr> <tr><td>146</td><td>回零参数</td><td>homing_use_z_signal</td><td>是否使用z信号</td><td>0</td><td>0</td><td>0</td><td>0</td><td>1</td><td>mm</td></tr> <tr><td>147</td><td>回零参数</td><td>homing_use_z_signal</td><td>是否使用z信号</td><td>0</td><td>0</td><td>0</td><td>0</td><td>1</td><td>mm</td></tr> <tr><td>148</td><td>回零参数</td><td>homing_use_z_signal</td><td>是否使用z信号</td><td>0</td><td>0</td><td>0</td><td>0</td><td>1</td><td>mm</td></tr> <tr><td>149</td><td>回零参数</td><td>homing_use_z_signal</td><td>是否使用z信号</td><td>0</td><td>0</td><td>0</td><td>0</td><td>1</td><td>mm</td></tr> <tr><td>150</td><td>回零参数</td><td>homing_use_z_signal</td><td>是否使用z信号</td><td>0</td><td>0</td><td>0</td><td>0</td><td>1</td><td>mm</td></tr> <tr><td>151</td><td>回零参数</td><td>homing_use_z_signal</td><td>是否使用z信号</td><td>0</td><td>0</td><td>0</td><td>0</td><td>1</td><td>mm</td></tr> <tr><td>152</td><td>回零参数</td><td>homing_use_z_signal</td><td>是否使用z信号</td><td>0</td><td>0</td><td>0</td><td>0</td><td>1</td><td>mm</td></tr> <tr><td>153</td><td>回零参数</td><td>homing_use_z_signal</td><td>是否使用z信号</td><td>0</td><td>0</td><td>0</td><td>0</td><td>1</td><td>mm</td></tr> <tr><td>154</td><td>回零参数</td><td>homing_use_z_signal</td><td>是否使用z信号</td><td>0</td><td>0</td><td>0</td><td>0</td><td>1</td><td>mm</td></tr> <tr><td>155</td><td>回零参数</td><td>homing_use_z_signal</td><td>是否使用z信号</td><td>0</td><td>0</td><td>0</td><td>0</td><td>1</td><td>mm</td></tr> <tr><td>156</td><td>回零参数</td><td>homing_use_z_signal</td><td>是否使用z信号</td><td>0</td><td>0</td><td>0</td><td>0</td><td>1</td><td>mm</td></tr> <tr><td>157</td><td>回零参数</td><td>homing_use_z_signal</td><td>是否使用z信号</td><td>0</td><td>0</td><td>0</td><td>0</td><td>1</td><td>mm</td></tr> <tr><td>158</td><td>回零参数</td><td>homing_use_z_signal</td><td>是否使用z信号</td><td>0</td><td>0</td><td>0</td><td>0</td><td>1</td><td>mm</td></tr> <tr><td>159</td><td>回零参数</td><td>homing_use_z_signal</td><td>是否使用z信号</td><td>0</td><td>0</td><td>0</td><td>0</td><td>1</td><td>mm</td></tr> <tr><td>160</td><td>回零参数</td><td>homing_use_z_signal</td><td>是否使用z信号</td><td>0</td><td>0</td><td>0</td><td>0</td><td>1</td><td>mm</td></tr> <tr><td>161</td><td>回零参数</td><td>homing_use_z_signal</td><td>是否使用z信号</td><td>0</td><td>0</td><td>0</td><td>0</td><td>1</td><td>mm</td></tr> <tr><td>162</td><td>回零参数</td><td>homing_use_z_signal</td><td>是否使用z信号</td><td>0</td><td>0</td><td>0</td><td>0</td><td>1</td><td>mm</td></tr> <tr><td>163</td><td>回零参数</td><td>homing_use_z_signal</td><td>是否使用z信号</td><td>0</td><td>0</td><td>0</td><td>0</td><td>1</td><td>mm</td></tr> <tr><td>164</td><td>回零参数</td><td>homing_use_z_signal</td><td>是否使用z信号</td><td>0</td><td>0</td><td>0</td><td>0</td><td>1</td><td>mm</td></tr> <tr><td>165</td><td>回零参数</td><td>homing_use_z_signal</td><td>是否使用z信号</td><td>0</td><td>0</td><td>0</td><td>0</td><td>1</td><td>mm</td></tr> <tr><td>166</td><td>回零参数</td><td>homing_use_z_signal</td><td>是否使用z信号</td><td>0</td><td>0</td><td>0</td><td>0</td><td>1</td><td>mm</td></tr> <tr><td>167</td><td>回零参数</td><td>homing_use_z_signal</td><td>是否使用z信号</td><td>0</td><td>0</td><td>0</td><td>0</td><td>1</td><td>mm</td></tr> <tr><td>168</td><td>回零参数</td><td>homing_use_z_signal</td><td>是否使用z信号</td><td>0</td><td>0</td><td>0</td><td>0</td><td>1</td><td>mm</td></tr> <tr><td>169</td><td>回零参数</td><td>homing_use_z_signal</td><td>是否使用z信号</td><td>0</td><td>0</td><td>0</td><td>0</td><td>1</td><td>mm</td></tr> <tr><td>170</td><td>回零参数</td><td>homing_use_z_signal</td><td>是否使用z信号</td><td>0</td><td>0</td><td>0</td><td>0</td><td>1</td><td>mm</td></tr> <tr><td>171</td><td>回零参数</td><td>homing_use_z_signal</td><td>是否使用z信号</td><td>0</td><td>0</td><td>0</td><td>0</td><td>1</td><td>mm</td></tr> <tr><td>172</td><td>回零参数</td><td>homing_use_z_signal</td><td>是否使用z信号</td><td>0</td><td>0</td><td>0</td><td>0</td><td>1</td><td>mm</td></tr> <tr><td>173</td><td>回零参数</td><td>homing_use_z_signal</td><td>是否使用z信号</td><td>0</td><td>0</td><td>0</td><td>0</td><td>1</td><td>mm</td></tr> <tr><td>174</td><td>回零参数</td><td>homing_use_z_signal</td><td>是否使用z信号</td><td>0</td><td>0</td><td>0</td><td>0</td><td>1</td><td>mm</td></tr> <tr><td>175</td><td>回零参数</td><td>homing_use_z_signal</td><td>是否使用z信号</td><td>0</td><td>0</td><td>0</td><td>0</td><td>1</td><td>mm</td></tr> <tr><td>176</td><td>回零参数</td><td>homing_use_z_signal</td><td>是否使用z信号</td><td>0</td><td>0</td><td>0</td><td>0</td><td>1</td><td>mm</td></tr> <tr><td>177</td><td>回零参数</td><td>homing_use_z_signal</td><td>是否使用z信号</td><td>0</td><td>0</td><td>0</td><td>0</td><td>1</td><td>mm</td></tr> <tr><td>178</td><td>回零参数</td><td>homing_use_z_signal</td><td>是否使用z信号</td><td>0</td><td>0</td><td>0</td><td>0</td><td>1</td><td>mm</td></tr> <tr><td>179</td><td>回零参数</td><td>homing_use_z_signal</td><td>是否使用z信号</td><td>0</td><td>0</td><td>0</td><td>0</td><td>1</td><td>mm</td></tr> <tr><td>180</td><td>回零参数</td><td>homing_use_z_signal</td><td>是否使用z信号</td><td>0</td><td>0</td><td>0</td><td>0</td><td>1</td><td>mm</td></tr> <tr><td>181</td><td>回零参数</td><td>homing_use_z_signal</td><td>是否使用z信号</td><td>0</td><td>0</td><td>0</td><td>0</td><td>1</td><td>mm</td></tr> <tr><td>182</td><td>回零参数</td><td>homing_use_z_signal</td><td>是否使用z信号</td><td>0</td><td>0</td><td>0</td><td>0</td><td>1</td><td>mm</td></tr> <tr><td>183</td><td>回零参数</td><td>homing_use_z_signal</td><td>是否使用z信号</td><td>0</td><td>0</td><td>0</td><td>0</td><td>1</td><td>mm</td></tr> <tr><td>184</td><td>回零参数</td><td>homing_use_z_signal</td><td>是否使用z信号</td><td>0</td><td>0</td><td>0</td><td>0</td><td>1</td><td>mm</td></tr> <tr><td>185</td><td>回零参数</td><td>homing_use_z_signal</td><td>是否使用z信号</td><td>0</td><td>0</td><td>0</td><td>0</td><td>1</td><td>mm</td></tr> <tr><td>186</td><td>回零参数</td><td>homing_use_z_signal</td><td>是否使用z信号</td><td>0</td><td>0</td><td>0</td><td>0</td><td>1</td><td>mm</td></tr> <tr><td>187</td><td>回零参数</td><td>homing_use_z_signal</td><td>是否使用z信号</td><td>0</td><td>0</td><td>0</td><td>0</td><td>1</td><td>mm</td></tr> <tr><td>188</td><td>回零参数</td><td>homing_use_z_signal</td><td>是否使用z信号</td><td>0</td><td>0</td><td>0</td><td>0</td><td>1</td><td>mm</td></tr> <tr><td>189</td><td>回零参数</td><td>homing_use_z_signal</td><td>是否使用z信号</td><td>0</td><td>0</td><td>0</td><td>0</td><td>1</td><td>mm</td></tr> <tr><td>190</td><td>回零参数</td><td>homing_use_z_signal</td><td>是否使用z信号</td><td>0</td><td>0</td><td>0</td><td>0</td><td>1</td><td>mm</td></tr> <tr><td>191</td><td>回零参数</td><td>homing_use_z_signal</td><td>是否使用z信号</td><td>0</td><td>0</td><td>0</td><td>0</td><td>1</td><td>mm</td></tr> <tr><td>192</td><td>回零参数</td><td>homing_use_z_signal</td><td>是否使用z信号</td><td>0</td><td>0</td><td>0</td><td>0</td><td>1</td><td>mm</td></tr> <tr><td>193</td><td>回零参数</td><td>homing_use_z_signal</td><td>是否使用z信号</td><td>0</td><td>0</td><td>0</td><td>0</td><td>1</td><td>mm</td></tr> <tr><td>194</td><td>回零参数</td><td>homing_use_z_signal</td><td>是否使用z信号</td><td>0</td><td>0</td><td>0</td><td>0</td><td>1</td><td>mm</td></tr> <tr><td>195</td><td>回零参数</td><td>homing_use_z_signal</td><td>是否使用z信号</td><td>0</td><td>0</td><td>0</td><td>0</td><td>1</td><td>mm</td></tr> <tr><td>196</td><td>回零参数</td><td>homing_use_z_signal</td><td>是否使用z信号</td><td>0</td><td>0</td><td>0</td><td>0</td><td>1</td><td>mm</td></tr> <tr><td>197</td><td>回零参数</td><td>homing_use_z_signal</td><td>是否使用z信号</td><td>0</td><td>0</td><td>0</td><td>0</td><td>1</td><td>mm</td></tr> <tr><td>198</td><td>回零参数</td><td>homing_use_z_signal</td><td>是否使用z信号</td><td>0</td><td>0</td><td>0</td><td>0</td><td>1</td><td>mm</td></tr> <tr><td>199</td><td>回零参数</td><td>homing_use_z_signal</td><td>是否使用z信号</td><td>0</td><td>0</td><td>0</td><td>0</td><td>1</td><td>mm</td></tr> <tr><td>200</td><td>回零参数</td><td>homing_use_z_signal</td><td>是否使用z信号</td><td>0</td><td>0</td><td>0</td><td>0</td><td>1</td><td>mm</td></tr> </tbody> </table>	参数号	参数名称	参数名	描述	设置值	当前值	出厂值	最小值	最大值	单位	42	限位参数	target_maxhd_shrshld	位置禁止限值	-10	-10	-10	-10	16	2°/s	43	限位参数	target_maxhd_shrshld	位置禁止限值	10	10	10	10	16	mm	44	限位参数	velocity_maxhd_shrshld	速度禁止限值	10	10	10	1	6000	rpm	45	限位参数	velocity_maxhd_shrshld	速度禁止限值	10	10	10	1	6000	mm	70	限位参数	absShld_Shrshld	零速检测	2	2	2	1	6000	rpm	71	限位参数	absShld_Shrshld	零速检测	10	10	10	1	6000	mm	74	保护中间参数	following_error_maxdeviating_makda	跟踪误差最大值	0	0	0	0	1	mm	75	保护中间参数	following_error_maxdeviating_makda	跟踪误差最大值	-4	-4	-4	-10	16	2°/s	76	保护中间参数	following_error_shrshld	跟踪误差限值	-2	-2	-2	-10	16	mm	77	保护中间参数	following_error_shrshld	跟踪误差限值	200	200	200	0	1	mm	82	保护中间参数	stop_prntnc_velocity_maxshld	轴停止速度限值	0	0	0	0	1	rpm	83	保护中间参数	stop_prntnc_velocity_maxshld	轴停止速度限值	2	2	2	1	6000	rpm	84	保护中间参数	stop_prntnc_velocity_maxshld	轴停止速度限值	100	100	100	1	100	%	85	保护中间参数	stop_prntnc_velocity_maxshld	轴停止速度限值	200	200	200	2	1	mm	86	保护中间参数	stop_prntnc_velocity_maxshld	轴停止速度限值	1	1	1	0	1	mm	87	保护中间参数	stop_prntnc_velocity_maxshld	轴停止速度限值	0	0	0	0	1	mm	88	保护中间参数	stop_prntnc_velocity_maxshld	轴停止速度限值	0	0	0	0	1	mm	89	保护中间参数	stop_prntnc_velocity_maxshld	轴停止速度限值	0	0	0	0	1	mm	90	保护中间参数	stop_prntnc_velocity_maxshld	轴停止速度限值	0	0	0	0	1	mm	91	保护中间参数	stop_prntnc_velocity_maxshld	轴停止速度限值	0	0	0	0	1	mm	92	保护中间参数	stop_prntnc_velocity_maxshld	轴停止速度限值	0	0	0	0	1	mm	93	保护中间参数	stop_prntnc_velocity_maxshld	轴停止速度限值	0	0	0	0	1	mm	94	保护中间参数	stop_prntnc_velocity_maxshld	轴停止速度限值	0	0	0	0	1	mm	95	保护中间参数	stop_prntnc_velocity_maxshld	轴停止速度限值	0	0	0	0	1	mm	96	保护中间参数	stop_prntnc_velocity_maxshld	轴停止速度限值	0	0	0	0	1	mm	97	保护中间参数	stop_prntnc_velocity_maxshld	轴停止速度限值	0	0	0	0	1	mm	98	保护中间参数	stop_prntnc_velocity_maxshld	轴停止速度限值	0	0	0	0	1	mm	99	保护中间参数	stop_prntnc_velocity_maxshld	轴停止速度限值	0	0	0	0	1	mm	100	保护中间参数	stop_prntnc_velocity_maxshld	轴停止速度限值	0	0	0	0	1	mm	101	保护中间参数	stop_prntnc_velocity_maxshld	轴停止速度限值	0	0	0	0	1	mm	102	保护中间参数	stop_prntnc_velocity_maxshld	轴停止速度限值	0	0	0	0	1	mm	103	保护中间参数	stop_prntnc_velocity_maxshld	轴停止速度限值	0	0	0	0	1	mm	104	回零参数	homing_method	回零方法	1	1	1	0	1	mm	105	回零参数	homing_method	回零方法	0	0	0	0	1	mm	106	回零参数	homing_use_z_signal	是否使用z信号	0	0	0	0	1	mm	107	回零参数	homing_use_z_signal	是否使用z信号	1	1	1	0	1	mm	108	回零参数	homing_use_z_signal	是否使用z信号	0	0	0	0	1	mm	109	回零参数	homing_use_z_signal	是否使用z信号	0	0	0	0	1	mm	110	回零参数	homing_use_z_signal	是否使用z信号	0	0	0	0	1	mm	111	回零参数	homing_use_z_signal	是否使用z信号	0	0	0	0	1	mm	112	回零参数	homing_use_z_signal	是否使用z信号	0	0	0	0	1	mm	113	回零参数	homing_use_z_signal	是否使用z信号	0	0	0	0	1	mm	114	回零参数	homing_use_z_signal	是否使用z信号	0	0	0	0	1	mm	115	回零参数	homing_use_z_signal	是否使用z信号	0	0	0	0	1	mm	116	回零参数	homing_use_z_signal	是否使用z信号	0	0	0	0	1	mm	117	回零参数	homing_use_z_signal	是否使用z信号	0	0	0	0	1	mm	118	回零参数	homing_use_z_signal	是否使用z信号	0	0	0	0	1	mm	119	回零参数	homing_use_z_signal	是否使用z信号	0	0	0	0	1	mm	120	回零参数	homing_use_z_signal	是否使用z信号	0	0	0	0	1	mm	121	回零参数	homing_use_z_signal	是否使用z信号	0	0	0	0	1	mm	122	回零参数	homing_use_z_signal	是否使用z信号	0	0	0	0	1	mm	123	回零参数	homing_use_z_signal	是否使用z信号	0	0	0	0	1	mm	124	回零参数	homing_use_z_signal	是否使用z信号	0	0	0	0	1	mm	125	回零参数	homing_use_z_signal	是否使用z信号	0	0	0	0	1	mm	126	回零参数	homing_use_z_signal	是否使用z信号	0	0	0	0	1	mm	127	回零参数	homing_use_z_signal	是否使用z信号	0	0	0	0	1	mm	128	回零参数	homing_use_z_signal	是否使用z信号	0	0	0	0	1	mm	129	回零参数	homing_use_z_signal	是否使用z信号	0	0	0	0	1	mm	130	回零参数	homing_use_z_signal	是否使用z信号	0	0	0	0	1	mm	131	回零参数	homing_use_z_signal	是否使用z信号	0	0	0	0	1	mm	132	回零参数	homing_use_z_signal	是否使用z信号	0	0	0	0	1	mm	133	回零参数	homing_use_z_signal	是否使用z信号	0	0	0	0	1	mm	134	回零参数	homing_use_z_signal	是否使用z信号	0	0	0	0	1	mm	135	回零参数	homing_use_z_signal	是否使用z信号	0	0	0	0	1	mm	136	回零参数	homing_use_z_signal	是否使用z信号	0	0	0	0	1	mm	137	回零参数	homing_use_z_signal	是否使用z信号	0	0	0	0	1	mm	138	回零参数	homing_use_z_signal	是否使用z信号	0	0	0	0	1	mm	139	回零参数	homing_use_z_signal	是否使用z信号	0	0	0	0	1	mm	140	回零参数	homing_use_z_signal	是否使用z信号	0	0	0	0	1	mm	141	回零参数	homing_use_z_signal	是否使用z信号	0	0	0	0	1	mm	142	回零参数	homing_use_z_signal	是否使用z信号	0	0	0	0	1	mm	143	回零参数	homing_use_z_signal	是否使用z信号	0	0	0	0	1	mm	144	回零参数	homing_use_z_signal	是否使用z信号	0	0	0	0	1	mm	145	回零参数	homing_use_z_signal	是否使用z信号	0	0	0	0	1	mm	146	回零参数	homing_use_z_signal	是否使用z信号	0	0	0	0	1	mm	147	回零参数	homing_use_z_signal	是否使用z信号	0	0	0	0	1	mm	148	回零参数	homing_use_z_signal	是否使用z信号	0	0	0	0	1	mm	149	回零参数	homing_use_z_signal	是否使用z信号	0	0	0	0	1	mm	150	回零参数	homing_use_z_signal	是否使用z信号	0	0	0	0	1	mm	151	回零参数	homing_use_z_signal	是否使用z信号	0	0	0	0	1	mm	152	回零参数	homing_use_z_signal	是否使用z信号	0	0	0	0	1	mm	153	回零参数	homing_use_z_signal	是否使用z信号	0	0	0	0	1	mm	154	回零参数	homing_use_z_signal	是否使用z信号	0	0	0	0	1	mm	155	回零参数	homing_use_z_signal	是否使用z信号	0	0	0	0	1	mm	156	回零参数	homing_use_z_signal	是否使用z信号	0	0	0	0	1	mm	157	回零参数	homing_use_z_signal	是否使用z信号	0	0	0	0	1	mm	158	回零参数	homing_use_z_signal	是否使用z信号	0	0	0	0	1	mm	159	回零参数	homing_use_z_signal	是否使用z信号	0	0	0	0	1	mm	160	回零参数	homing_use_z_signal	是否使用z信号	0	0	0	0	1	mm	161	回零参数	homing_use_z_signal	是否使用z信号	0	0	0	0	1	mm	162	回零参数	homing_use_z_signal	是否使用z信号	0	0	0	0	1	mm	163	回零参数	homing_use_z_signal	是否使用z信号	0	0	0	0	1	mm	164	回零参数	homing_use_z_signal	是否使用z信号	0	0	0	0	1	mm	165	回零参数	homing_use_z_signal	是否使用z信号	0	0	0	0	1	mm	166	回零参数	homing_use_z_signal	是否使用z信号	0	0	0	0	1	mm	167	回零参数	homing_use_z_signal	是否使用z信号	0	0	0	0	1	mm	168	回零参数	homing_use_z_signal	是否使用z信号	0	0	0	0	1	mm	169	回零参数	homing_use_z_signal	是否使用z信号	0	0	0	0	1	mm	170	回零参数	homing_use_z_signal	是否使用z信号	0	0	0	0	1	mm	171	回零参数	homing_use_z_signal	是否使用z信号	0	0	0	0	1	mm	172	回零参数	homing_use_z_signal	是否使用z信号	0	0	0	0	1	mm	173	回零参数	homing_use_z_signal	是否使用z信号	0	0	0	0	1	mm	174	回零参数	homing_use_z_signal	是否使用z信号	0	0	0	0	1	mm	175	回零参数	homing_use_z_signal	是否使用z信号	0	0	0	0	1	mm	176	回零参数	homing_use_z_signal	是否使用z信号	0	0	0	0	1	mm	177	回零参数	homing_use_z_signal	是否使用z信号	0	0	0	0	1	mm	178	回零参数	homing_use_z_signal	是否使用z信号	0	0	0	0	1	mm	179	回零参数	homing_use_z_signal	是否使用z信号	0	0	0	0	1	mm	180	回零参数	homing_use_z_signal	是否使用z信号	0	0	0	0	1	mm	181	回零参数	homing_use_z_signal	是否使用z信号	0	0	0	0	1	mm	182	回零参数	homing_use_z_signal	是否使用z信号	0	0	0	0	1	mm	183	回零参数	homing_use_z_signal	是否使用z信号	0	0	0	0	1	mm	184	回零参数	homing_use_z_signal	是否使用z信号	0	0	0	0	1	mm	185	回零参数	homing_use_z_signal	是否使用z信号	0	0	0	0	1	mm	186	回零参数	homing_use_z_signal	是否使用z信号	0	0	0	0	1	mm	187	回零参数	homing_use_z_signal	是否使用z信号	0	0	0	0	1	mm	188	回零参数	homing_use_z_signal	是否使用z信号	0	0	0	0	1	mm	189	回零参数	homing_use_z_signal	是否使用z信号	0	0	0	0	1	mm	190	回零参数	homing_use_z_signal	是否使用z信号	0	0	0	0	1	mm	191	回零参数	homing_use_z_signal	是否使用z信号	0	0	0	0	1	mm	192	回零参数	homing_use_z_signal	是否使用z信号	0	0	0	0	1	mm	193	回零参数	homing_use_z_signal	是否使用z信号	0	0	0	0	1	mm	194	回零参数	homing_use_z_signal	是否使用z信号	0	0	0	0	1	mm	195	回零参数	homing_use_z_signal	是否使用z信号	0	0	0	0	1	mm	196	回零参数	homing_use_z_signal	是否使用z信号	0	0	0	0	1	mm	197	回零参数	homing_use_z_signal	是否使用z信号	0	0	0	0	1	mm	198	回零参数	homing_use_z_signal	是否使用z信号	0	0	0	0	1	mm	199	回零参数	homing_use_z_signal	是否使用z信号	0	0	0	0	1	mm	200	回零参数	homing_use_z_signal	是否使用z信号	0	0	0	0	1	mm
参数号	参数名称	参数名	描述	设置值	当前值	出厂值	最小值	最大值	单位																																																																																																																																																																																																																																																																																																																																																																																																																																																																																																																																																																																																																																																																																																																																																																																																																																																																																																																																																																																																																																																																																																																																																																																																																																																																																																																																												
42	限位参数	target_maxhd_shrshld	位置禁止限值	-10	-10	-10	-10	16	2°/s																																																																																																																																																																																																																																																																																																																																																																																																																																																																																																																																																																																																																																																																																																																																																																																																																																																																																																																																																																																																																																																																																																																																																																																																																																																																																																																																												
43	限位参数	target_maxhd_shrshld	位置禁止限值	10	10	10	10	16	mm																																																																																																																																																																																																																																																																																																																																																																																																																																																																																																																																																																																																																																																																																																																																																																																																																																																																																																																																																																																																																																																																																																																																																																																																																																																																																																																																												
44	限位参数	velocity_maxhd_shrshld	速度禁止限值	10	10	10	1	6000	rpm																																																																																																																																																																																																																																																																																																																																																																																																																																																																																																																																																																																																																																																																																																																																																																																																																																																																																																																																																																																																																																																																																																																																																																																																																																																																																																																																												
45	限位参数	velocity_maxhd_shrshld	速度禁止限值	10	10	10	1	6000	mm																																																																																																																																																																																																																																																																																																																																																																																																																																																																																																																																																																																																																																																																																																																																																																																																																																																																																																																																																																																																																																																																																																																																																																																																																																																																																																																																												
70	限位参数	absShld_Shrshld	零速检测	2	2	2	1	6000	rpm																																																																																																																																																																																																																																																																																																																																																																																																																																																																																																																																																																																																																																																																																																																																																																																																																																																																																																																																																																																																																																																																																																																																																																																																																																																																																																																																												
71	限位参数	absShld_Shrshld	零速检测	10	10	10	1	6000	mm																																																																																																																																																																																																																																																																																																																																																																																																																																																																																																																																																																																																																																																																																																																																																																																																																																																																																																																																																																																																																																																																																																																																																																																																																																																																																																																																												
74	保护中间参数	following_error_maxdeviating_makda	跟踪误差最大值	0	0	0	0	1	mm																																																																																																																																																																																																																																																																																																																																																																																																																																																																																																																																																																																																																																																																																																																																																																																																																																																																																																																																																																																																																																																																																																																																																																																																																																																																																																																																												
75	保护中间参数	following_error_maxdeviating_makda	跟踪误差最大值	-4	-4	-4	-10	16	2°/s																																																																																																																																																																																																																																																																																																																																																																																																																																																																																																																																																																																																																																																																																																																																																																																																																																																																																																																																																																																																																																																																																																																																																																																																																																																																																																																																												
76	保护中间参数	following_error_shrshld	跟踪误差限值	-2	-2	-2	-10	16	mm																																																																																																																																																																																																																																																																																																																																																																																																																																																																																																																																																																																																																																																																																																																																																																																																																																																																																																																																																																																																																																																																																																																																																																																																																																																																																																																																												
77	保护中间参数	following_error_shrshld	跟踪误差限值	200	200	200	0	1	mm																																																																																																																																																																																																																																																																																																																																																																																																																																																																																																																																																																																																																																																																																																																																																																																																																																																																																																																																																																																																																																																																																																																																																																																																																																																																																																																																												
82	保护中间参数	stop_prntnc_velocity_maxshld	轴停止速度限值	0	0	0	0	1	rpm																																																																																																																																																																																																																																																																																																																																																																																																																																																																																																																																																																																																																																																																																																																																																																																																																																																																																																																																																																																																																																																																																																																																																																																																																																																																																																																																												
83	保护中间参数	stop_prntnc_velocity_maxshld	轴停止速度限值	2	2	2	1	6000	rpm																																																																																																																																																																																																																																																																																																																																																																																																																																																																																																																																																																																																																																																																																																																																																																																																																																																																																																																																																																																																																																																																																																																																																																																																																																																																																																																																												
84	保护中间参数	stop_prntnc_velocity_maxshld	轴停止速度限值	100	100	100	1	100	%																																																																																																																																																																																																																																																																																																																																																																																																																																																																																																																																																																																																																																																																																																																																																																																																																																																																																																																																																																																																																																																																																																																																																																																																																																																																																																																																												
85	保护中间参数	stop_prntnc_velocity_maxshld	轴停止速度限值	200	200	200	2	1	mm																																																																																																																																																																																																																																																																																																																																																																																																																																																																																																																																																																																																																																																																																																																																																																																																																																																																																																																																																																																																																																																																																																																																																																																																																																																																																																																																												
86	保护中间参数	stop_prntnc_velocity_maxshld	轴停止速度限值	1	1	1	0	1	mm																																																																																																																																																																																																																																																																																																																																																																																																																																																																																																																																																																																																																																																																																																																																																																																																																																																																																																																																																																																																																																																																																																																																																																																																																																																																																																																																												
87	保护中间参数	stop_prntnc_velocity_maxshld	轴停止速度限值	0	0	0	0	1	mm																																																																																																																																																																																																																																																																																																																																																																																																																																																																																																																																																																																																																																																																																																																																																																																																																																																																																																																																																																																																																																																																																																																																																																																																																																																																																																																																												
88	保护中间参数	stop_prntnc_velocity_maxshld	轴停止速度限值	0	0	0	0	1	mm																																																																																																																																																																																																																																																																																																																																																																																																																																																																																																																																																																																																																																																																																																																																																																																																																																																																																																																																																																																																																																																																																																																																																																																																																																																																																																																																												
89	保护中间参数	stop_prntnc_velocity_maxshld	轴停止速度限值	0	0	0	0	1	mm																																																																																																																																																																																																																																																																																																																																																																																																																																																																																																																																																																																																																																																																																																																																																																																																																																																																																																																																																																																																																																																																																																																																																																																																																																																																																																																																												
90	保护中间参数	stop_prntnc_velocity_maxshld	轴停止速度限值	0	0	0	0	1	mm																																																																																																																																																																																																																																																																																																																																																																																																																																																																																																																																																																																																																																																																																																																																																																																																																																																																																																																																																																																																																																																																																																																																																																																																																																																																																																																																												
91	保护中间参数	stop_prntnc_velocity_maxshld	轴停止速度限值	0	0	0	0	1	mm																																																																																																																																																																																																																																																																																																																																																																																																																																																																																																																																																																																																																																																																																																																																																																																																																																																																																																																																																																																																																																																																																																																																																																																																																																																																																																																																												
92	保护中间参数	stop_prntnc_velocity_maxshld	轴停止速度限值	0	0	0	0	1	mm																																																																																																																																																																																																																																																																																																																																																																																																																																																																																																																																																																																																																																																																																																																																																																																																																																																																																																																																																																																																																																																																																																																																																																																																																																																																																																																																												
93	保护中间参数	stop_prntnc_velocity_maxshld	轴停止速度限值	0	0	0	0	1	mm																																																																																																																																																																																																																																																																																																																																																																																																																																																																																																																																																																																																																																																																																																																																																																																																																																																																																																																																																																																																																																																																																																																																																																																																																																																																																																																																												
94	保护中间参数	stop_prntnc_velocity_maxshld	轴停止速度限值	0	0	0	0	1	mm																																																																																																																																																																																																																																																																																																																																																																																																																																																																																																																																																																																																																																																																																																																																																																																																																																																																																																																																																																																																																																																																																																																																																																																																																																																																																																																																												
95	保护中间参数	stop_prntnc_velocity_maxshld	轴停止速度限值	0	0	0	0	1	mm																																																																																																																																																																																																																																																																																																																																																																																																																																																																																																																																																																																																																																																																																																																																																																																																																																																																																																																																																																																																																																																																																																																																																																																																																																																																																																																																												
96	保护中间参数	stop_prntnc_velocity_maxshld	轴停止速度限值	0	0	0	0	1	mm																																																																																																																																																																																																																																																																																																																																																																																																																																																																																																																																																																																																																																																																																																																																																																																																																																																																																																																																																																																																																																																																																																																																																																																																																																																																																																																																												
97	保护中间参数	stop_prntnc_velocity_maxshld	轴停止速度限值	0	0	0	0	1	mm																																																																																																																																																																																																																																																																																																																																																																																																																																																																																																																																																																																																																																																																																																																																																																																																																																																																																																																																																																																																																																																																																																																																																																																																																																																																																																																																												
98	保护中间参数	stop_prntnc_velocity_maxshld	轴停止速度限值	0	0	0	0	1	mm																																																																																																																																																																																																																																																																																																																																																																																																																																																																																																																																																																																																																																																																																																																																																																																																																																																																																																																																																																																																																																																																																																																																																																																																																																																																																																																																												
99	保护中间参数	stop_prntnc_velocity_maxshld	轴停止速度限值	0	0	0	0	1	mm																																																																																																																																																																																																																																																																																																																																																																																																																																																																																																																																																																																																																																																																																																																																																																																																																																																																																																																																																																																																																																																																																																																																																																																																																																																																																																																																												
100	保护中间参数	stop_prntnc_velocity_maxshld	轴停止速度限值	0	0	0	0	1	mm																																																																																																																																																																																																																																																																																																																																																																																																																																																																																																																																																																																																																																																																																																																																																																																																																																																																																																																																																																																																																																																																																																																																																																																																																																																																																																																																												
101	保护中间参数	stop_prntnc_velocity_maxshld	轴停止速度限值	0	0	0	0	1	mm																																																																																																																																																																																																																																																																																																																																																																																																																																																																																																																																																																																																																																																																																																																																																																																																																																																																																																																																																																																																																																																																																																																																																																																																																																																																																																																																												
102	保护中间参数	stop_prntnc_velocity_maxshld	轴停止速度限值	0	0	0	0	1	mm																																																																																																																																																																																																																																																																																																																																																																																																																																																																																																																																																																																																																																																																																																																																																																																																																																																																																																																																																																																																																																																																																																																																																																																																																																																																																																																																												
103	保护中间参数	stop_prntnc_velocity_maxshld	轴停止速度限值	0	0	0	0	1	mm																																																																																																																																																																																																																																																																																																																																																																																																																																																																																																																																																																																																																																																																																																																																																																																																																																																																																																																																																																																																																																																																																																																																																																																																																																																																																																																																												
104	回零参数	homing_method	回零方法	1	1	1	0	1	mm																																																																																																																																																																																																																																																																																																																																																																																																																																																																																																																																																																																																																																																																																																																																																																																																																																																																																																																																																																																																																																																																																																																																																																																																																																																																																																																																												
105	回零参数	homing_method	回零方法	0	0	0	0	1	mm																																																																																																																																																																																																																																																																																																																																																																																																																																																																																																																																																																																																																																																																																																																																																																																																																																																																																																																																																																																																																																																																																																																																																																																																																																																																																																																																												
106	回零参数	homing_use_z_signal	是否使用z信号	0	0	0	0	1	mm																																																																																																																																																																																																																																																																																																																																																																																																																																																																																																																																																																																																																																																																																																																																																																																																																																																																																																																																																																																																																																																																																																																																																																																																																																																																																																																																												
107	回零参数	homing_use_z_signal	是否使用z信号	1	1	1	0	1	mm																																																																																																																																																																																																																																																																																																																																																																																																																																																																																																																																																																																																																																																																																																																																																																																																																																																																																																																																																																																																																																																																																																																																																																																																																																																																																																																																												
108	回零参数	homing_use_z_signal	是否使用z信号	0	0	0	0	1	mm																																																																																																																																																																																																																																																																																																																																																																																																																																																																																																																																																																																																																																																																																																																																																																																																																																																																																																																																																																																																																																																																																																																																																																																																																																																																																																																																												
109	回零参数	homing_use_z_signal	是否使用z信号	0	0	0	0	1	mm																																																																																																																																																																																																																																																																																																																																																																																																																																																																																																																																																																																																																																																																																																																																																																																																																																																																																																																																																																																																																																																																																																																																																																																																																																																																																																																																												
110	回零参数	homing_use_z_signal	是否使用z信号	0	0	0	0	1	mm																																																																																																																																																																																																																																																																																																																																																																																																																																																																																																																																																																																																																																																																																																																																																																																																																																																																																																																																																																																																																																																																																																																																																																																																																																																																																																																																												
111	回零参数	homing_use_z_signal	是否使用z信号	0	0	0	0	1	mm																																																																																																																																																																																																																																																																																																																																																																																																																																																																																																																																																																																																																																																																																																																																																																																																																																																																																																																																																																																																																																																																																																																																																																																																																																																																																																																																												
112	回零参数	homing_use_z_signal	是否使用z信号	0	0	0	0	1	mm																																																																																																																																																																																																																																																																																																																																																																																																																																																																																																																																																																																																																																																																																																																																																																																																																																																																																																																																																																																																																																																																																																																																																																																																																																																																																																																																												
113	回零参数	homing_use_z_signal	是否使用z信号	0	0	0	0	1	mm																																																																																																																																																																																																																																																																																																																																																																																																																																																																																																																																																																																																																																																																																																																																																																																																																																																																																																																																																																																																																																																																																																																																																																																																																																																																																																																																												
114	回零参数	homing_use_z_signal	是否使用z信号	0	0	0	0	1	mm																																																																																																																																																																																																																																																																																																																																																																																																																																																																																																																																																																																																																																																																																																																																																																																																																																																																																																																																																																																																																																																																																																																																																																																																																																																																																																																																												
115	回零参数	homing_use_z_signal	是否使用z信号	0	0	0	0	1	mm																																																																																																																																																																																																																																																																																																																																																																																																																																																																																																																																																																																																																																																																																																																																																																																																																																																																																																																																																																																																																																																																																																																																																																																																																																																																																																																																												
116	回零参数	homing_use_z_signal	是否使用z信号	0	0	0	0	1	mm																																																																																																																																																																																																																																																																																																																																																																																																																																																																																																																																																																																																																																																																																																																																																																																																																																																																																																																																																																																																																																																																																																																																																																																																																																																																																																																																												
117	回零参数	homing_use_z_signal	是否使用z信号	0	0	0	0	1	mm																																																																																																																																																																																																																																																																																																																																																																																																																																																																																																																																																																																																																																																																																																																																																																																																																																																																																																																																																																																																																																																																																																																																																																																																																																																																																																																																												
118	回零参数	homing_use_z_signal	是否使用z信号	0	0	0	0	1	mm																																																																																																																																																																																																																																																																																																																																																																																																																																																																																																																																																																																																																																																																																																																																																																																																																																																																																																																																																																																																																																																																																																																																																																																																																																																																																																																																												
119	回零参数	homing_use_z_signal	是否使用z信号	0	0	0	0	1	mm																																																																																																																																																																																																																																																																																																																																																																																																																																																																																																																																																																																																																																																																																																																																																																																																																																																																																																																																																																																																																																																																																																																																																																																																																																																																																																																																												
120	回零参数	homing_use_z_signal	是否使用z信号	0	0	0	0	1	mm																																																																																																																																																																																																																																																																																																																																																																																																																																																																																																																																																																																																																																																																																																																																																																																																																																																																																																																																																																																																																																																																																																																																																																																																																																																																																																																																												
121	回零参数	homing_use_z_signal	是否使用z信号	0	0	0	0	1	mm																																																																																																																																																																																																																																																																																																																																																																																																																																																																																																																																																																																																																																																																																																																																																																																																																																																																																																																																																																																																																																																																																																																																																																																																																																																																																																																																												
122	回零参数	homing_use_z_signal	是否使用z信号	0	0	0	0	1	mm																																																																																																																																																																																																																																																																																																																																																																																																																																																																																																																																																																																																																																																																																																																																																																																																																																																																																																																																																																																																																																																																																																																																																																																																																																																																																																																																												
123	回零参数	homing_use_z_signal	是否使用z信号	0	0	0	0	1	mm																																																																																																																																																																																																																																																																																																																																																																																																																																																																																																																																																																																																																																																																																																																																																																																																																																																																																																																																																																																																																																																																																																																																																																																																																																																																																																																																												
124	回零参数	homing_use_z_signal	是否使用z信号	0	0	0	0	1	mm																																																																																																																																																																																																																																																																																																																																																																																																																																																																																																																																																																																																																																																																																																																																																																																																																																																																																																																																																																																																																																																																																																																																																																																																																																																																																																																																												
125	回零参数	homing_use_z_signal	是否使用z信号	0	0	0	0	1	mm																																																																																																																																																																																																																																																																																																																																																																																																																																																																																																																																																																																																																																																																																																																																																																																																																																																																																																																																																																																																																																																																																																																																																																																																																																																																																																																																												
126	回零参数	homing_use_z_signal	是否使用z信号	0	0	0	0	1	mm																																																																																																																																																																																																																																																																																																																																																																																																																																																																																																																																																																																																																																																																																																																																																																																																																																																																																																																																																																																																																																																																																																																																																																																																																																																																																																																																												
127	回零参数	homing_use_z_signal	是否使用z信号	0	0	0	0	1	mm																																																																																																																																																																																																																																																																																																																																																																																																																																																																																																																																																																																																																																																																																																																																																																																																																																																																																																																																																																																																																																																																																																																																																																																																																																																																																																																																												
128	回零参数	homing_use_z_signal	是否使用z信号	0	0	0	0	1	mm																																																																																																																																																																																																																																																																																																																																																																																																																																																																																																																																																																																																																																																																																																																																																																																																																																																																																																																																																																																																																																																																																																																																																																																																																																																																																																																																												
129	回零参数	homing_use_z_signal	是否使用z信号	0	0	0	0	1	mm																																																																																																																																																																																																																																																																																																																																																																																																																																																																																																																																																																																																																																																																																																																																																																																																																																																																																																																																																																																																																																																																																																																																																																																																																																																																																																																																												
130	回零参数	homing_use_z_signal	是否使用z信号	0	0	0	0	1	mm																																																																																																																																																																																																																																																																																																																																																																																																																																																																																																																																																																																																																																																																																																																																																																																																																																																																																																																																																																																																																																																																																																																																																																																																																																																																																																																																												
131	回零参数	homing_use_z_signal	是否使用z信号	0	0	0	0	1	mm																																																																																																																																																																																																																																																																																																																																																																																																																																																																																																																																																																																																																																																																																																																																																																																																																																																																																																																																																																																																																																																																																																																																																																																																																																																																																																																																												
132	回零参数	homing_use_z_signal	是否使用z信号	0	0	0	0	1	mm																																																																																																																																																																																																																																																																																																																																																																																																																																																																																																																																																																																																																																																																																																																																																																																																																																																																																																																																																																																																																																																																																																																																																																																																																																																																																																																																												
133	回零参数	homing_use_z_signal	是否使用z信号	0	0	0	0	1	mm																																																																																																																																																																																																																																																																																																																																																																																																																																																																																																																																																																																																																																																																																																																																																																																																																																																																																																																																																																																																																																																																																																																																																																																																																																																																																																																																												
134	回零参数	homing_use_z_signal	是否使用z信号	0	0	0	0	1	mm																																																																																																																																																																																																																																																																																																																																																																																																																																																																																																																																																																																																																																																																																																																																																																																																																																																																																																																																																																																																																																																																																																																																																																																																																																																																																																																																												
135	回零参数	homing_use_z_signal	是否使用z信号	0	0	0	0	1	mm																																																																																																																																																																																																																																																																																																																																																																																																																																																																																																																																																																																																																																																																																																																																																																																																																																																																																																																																																																																																																																																																																																																																																																																																																																																																																																																																												
136	回零参数	homing_use_z_signal	是否使用z信号	0	0	0	0	1	mm																																																																																																																																																																																																																																																																																																																																																																																																																																																																																																																																																																																																																																																																																																																																																																																																																																																																																																																																																																																																																																																																																																																																																																																																																																																																																																																																												
137	回零参数	homing_use_z_signal	是否使用z信号	0	0	0	0	1	mm																																																																																																																																																																																																																																																																																																																																																																																																																																																																																																																																																																																																																																																																																																																																																																																																																																																																																																																																																																																																																																																																																																																																																																																																																																																																																																																																												
138	回零参数	homing_use_z_signal	是否使用z信号	0	0	0	0	1	mm																																																																																																																																																																																																																																																																																																																																																																																																																																																																																																																																																																																																																																																																																																																																																																																																																																																																																																																																																																																																																																																																																																																																																																																																																																																																																																																																												
139	回零参数	homing_use_z_signal	是否使用z信号	0	0	0	0	1	mm																																																																																																																																																																																																																																																																																																																																																																																																																																																																																																																																																																																																																																																																																																																																																																																																																																																																																																																																																																																																																																																																																																																																																																																																																																																																																																																																												
140	回零参数	homing_use_z_signal	是否使用z信号	0	0	0	0	1	mm																																																																																																																																																																																																																																																																																																																																																																																																																																																																																																																																																																																																																																																																																																																																																																																																																																																																																																																																																																																																																																																																																																																																																																																																																																																																																																																																												
141	回零参数	homing_use_z_signal	是否使用z信号	0	0	0	0	1	mm																																																																																																																																																																																																																																																																																																																																																																																																																																																																																																																																																																																																																																																																																																																																																																																																																																																																																																																																																																																																																																																																																																																																																																																																																																																																																																																																												
142	回零参数	homing_use_z_signal	是否使用z信号	0	0	0	0	1	mm																																																																																																																																																																																																																																																																																																																																																																																																																																																																																																																																																																																																																																																																																																																																																																																																																																																																																																																																																																																																																																																																																																																																																																																																																																																																																																																																												
143	回零参数	homing_use_z_signal	是否使用z信号	0	0	0	0	1	mm																																																																																																																																																																																																																																																																																																																																																																																																																																																																																																																																																																																																																																																																																																																																																																																																																																																																																																																																																																																																																																																																																																																																																																																																																																																																																																																																												
144	回零参数	homing_use_z_signal	是否使用z信号	0	0	0	0	1	mm																																																																																																																																																																																																																																																																																																																																																																																																																																																																																																																																																																																																																																																																																																																																																																																																																																																																																																																																																																																																																																																																																																																																																																																																																																																																																																																																												
145	回零参数	homing_use_z_signal	是否使用z信号	0	0	0	0	1	mm																																																																																																																																																																																																																																																																																																																																																																																																																																																																																																																																																																																																																																																																																																																																																																																																																																																																																																																																																																																																																																																																																																																																																																																																																																																																																																																																												
146	回零参数	homing_use_z_signal	是否使用z信号	0	0	0	0	1	mm																																																																																																																																																																																																																																																																																																																																																																																																																																																																																																																																																																																																																																																																																																																																																																																																																																																																																																																																																																																																																																																																																																																																																																																																																																																																																																																																												
147	回零参数	homing_use_z_signal	是否使用z信号	0	0	0	0	1	mm																																																																																																																																																																																																																																																																																																																																																																																																																																																																																																																																																																																																																																																																																																																																																																																																																																																																																																																																																																																																																																																																																																																																																																																																																																																																																																																																												
148	回零参数	homing_use_z_signal	是否使用z信号	0	0	0	0	1	mm																																																																																																																																																																																																																																																																																																																																																																																																																																																																																																																																																																																																																																																																																																																																																																																																																																																																																																																																																																																																																																																																																																																																																																																																																																																																																																																																												
149	回零参数	homing_use_z_signal	是否使用z信号	0	0	0	0	1	mm																																																																																																																																																																																																																																																																																																																																																																																																																																																																																																																																																																																																																																																																																																																																																																																																																																																																																																																																																																																																																																																																																																																																																																																																																																																																																																																																												
150	回零参数	homing_use_z_signal	是否使用z信号	0	0	0	0	1	mm																																																																																																																																																																																																																																																																																																																																																																																																																																																																																																																																																																																																																																																																																																																																																																																																																																																																																																																																																																																																																																																																																																																																																																																																																																																																																																																																												
151	回零参数	homing_use_z_signal	是否使用z信号	0	0	0	0	1	mm																																																																																																																																																																																																																																																																																																																																																																																																																																																																																																																																																																																																																																																																																																																																																																																																																																																																																																																																																																																																																																																																																																																																																																																																																																																																																																																																												
152	回零参数	homing_use_z_signal	是否使用z信号	0	0	0	0	1	mm																																																																																																																																																																																																																																																																																																																																																																																																																																																																																																																																																																																																																																																																																																																																																																																																																																																																																																																																																																																																																																																																																																																																																																																																																																																																																																																																												
153	回零参数	homing_use_z_signal	是否使用z信号	0	0	0	0	1	mm																																																																																																																																																																																																																																																																																																																																																																																																																																																																																																																																																																																																																																																																																																																																																																																																																																																																																																																																																																																																																																																																																																																																																																																																																																																																																																																																												
154	回零参数	homing_use_z_signal	是否使用z信号	0	0	0	0	1	mm																																																																																																																																																																																																																																																																																																																																																																																																																																																																																																																																																																																																																																																																																																																																																																																																																																																																																																																																																																																																																																																																																																																																																																																																																																																																																																																																												
155	回零参数	homing_use_z_signal	是否使用z信号	0	0	0	0	1	mm																																																																																																																																																																																																																																																																																																																																																																																																																																																																																																																																																																																																																																																																																																																																																																																																																																																																																																																																																																																																																																																																																																																																																																																																																																																																																																																																												
156	回零参数	homing_use_z_signal	是否使用z信号	0	0	0	0	1	mm																																																																																																																																																																																																																																																																																																																																																																																																																																																																																																																																																																																																																																																																																																																																																																																																																																																																																																																																																																																																																																																																																																																																																																																																																																																																																																																																												
157	回零参数	homing_use_z_signal	是否使用z信号	0	0	0	0	1	mm																																																																																																																																																																																																																																																																																																																																																																																																																																																																																																																																																																																																																																																																																																																																																																																																																																																																																																																																																																																																																																																																																																																																																																																																																																																																																																																																												
158	回零参数	homing_use_z_signal	是否使用z信号	0	0	0	0	1	mm																																																																																																																																																																																																																																																																																																																																																																																																																																																																																																																																																																																																																																																																																																																																																																																																																																																																																																																																																																																																																																																																																																																																																																																																																																																																																																																																												
159	回零参数	homing_use_z_signal	是否使用z信号	0	0	0	0	1	mm																																																																																																																																																																																																																																																																																																																																																																																																																																																																																																																																																																																																																																																																																																																																																																																																																																																																																																																																																																																																																																																																																																																																																																																																																																																																																																																																												
160	回零参数	homing_use_z_signal	是否使用z信号	0	0	0	0	1	mm																																																																																																																																																																																																																																																																																																																																																																																																																																																																																																																																																																																																																																																																																																																																																																																																																																																																																																																																																																																																																																																																																																																																																																																																																																																																																																																																												
161	回零参数	homing_use_z_signal	是否使用z信号	0	0	0	0	1	mm																																																																																																																																																																																																																																																																																																																																																																																																																																																																																																																																																																																																																																																																																																																																																																																																																																																																																																																																																																																																																																																																																																																																																																																																																																																																																																																																												
162	回零参数	homing_use_z_signal	是否使用z信号	0	0	0	0	1	mm																																																																																																																																																																																																																																																																																																																																																																																																																																																																																																																																																																																																																																																																																																																																																																																																																																																																																																																																																																																																																																																																																																																																																																																																																																																																																																																																												
163	回零参数	homing_use_z_signal	是否使用z信号	0	0	0	0	1	mm																																																																																																																																																																																																																																																																																																																																																																																																																																																																																																																																																																																																																																																																																																																																																																																																																																																																																																																																																																																																																																																																																																																																																																																																																																																																																																																																												
164	回零参数	homing_use_z_signal	是否使用z信号	0	0	0	0	1	mm																																																																																																																																																																																																																																																																																																																																																																																																																																																																																																																																																																																																																																																																																																																																																																																																																																																																																																																																																																																																																																																																																																																																																																																																																																																																																																																																												
165	回零参数	homing_use_z_signal	是否使用z信号	0	0	0	0	1	mm																																																																																																																																																																																																																																																																																																																																																																																																																																																																																																																																																																																																																																																																																																																																																																																																																																																																																																																																																																																																																																																																																																																																																																																																																																																																																																																																												
166	回零参数	homing_use_z_signal	是否使用z信号	0	0	0	0	1	mm																																																																																																																																																																																																																																																																																																																																																																																																																																																																																																																																																																																																																																																																																																																																																																																																																																																																																																																																																																																																																																																																																																																																																																																																																																																																																																																																												
167	回零参数	homing_use_z_signal	是否使用z信号	0	0	0	0	1	mm																																																																																																																																																																																																																																																																																																																																																																																																																																																																																																																																																																																																																																																																																																																																																																																																																																																																																																																																																																																																																																																																																																																																																																																																																																																																																																																																												
168	回零参数	homing_use_z_signal	是否使用z信号	0	0	0	0	1	mm																																																																																																																																																																																																																																																																																																																																																																																																																																																																																																																																																																																																																																																																																																																																																																																																																																																																																																																																																																																																																																																																																																																																																																																																																																																																																																																																												
169	回零参数	homing_use_z_signal	是否使用z信号	0	0	0	0	1	mm																																																																																																																																																																																																																																																																																																																																																																																																																																																																																																																																																																																																																																																																																																																																																																																																																																																																																																																																																																																																																																																																																																																																																																																																																																																																																																																																												
170	回零参数	homing_use_z_signal	是否使用z信号	0	0	0	0	1	mm																																																																																																																																																																																																																																																																																																																																																																																																																																																																																																																																																																																																																																																																																																																																																																																																																																																																																																																																																																																																																																																																																																																																																																																																																																																																																																																																												
171	回零参数	homing_use_z_signal	是否使用z信号	0	0	0	0	1	mm																																																																																																																																																																																																																																																																																																																																																																																																																																																																																																																																																																																																																																																																																																																																																																																																																																																																																																																																																																																																																																																																																																																																																																																																																																																																																																																																												
172	回零参数	homing_use_z_signal	是否使用z信号	0	0	0	0	1	mm																																																																																																																																																																																																																																																																																																																																																																																																																																																																																																																																																																																																																																																																																																																																																																																																																																																																																																																																																																																																																																																																																																																																																																																																																																																																																																																																												
173	回零参数	homing_use_z_signal	是否使用z信号	0	0	0	0	1	mm																																																																																																																																																																																																																																																																																																																																																																																																																																																																																																																																																																																																																																																																																																																																																																																																																																																																																																																																																																																																																																																																																																																																																																																																																																																																																																																																												
174	回零参数	homing_use_z_signal	是否使用z信号	0	0	0	0	1	mm																																																																																																																																																																																																																																																																																																																																																																																																																																																																																																																																																																																																																																																																																																																																																																																																																																																																																																																																																																																																																																																																																																																																																																																																																																																																																																																																												
175	回零参数	homing_use_z_signal	是否使用z信号	0	0	0	0	1	mm																																																																																																																																																																																																																																																																																																																																																																																																																																																																																																																																																																																																																																																																																																																																																																																																																																																																																																																																																																																																																																																																																																																																																																																																																																																																																																																																												
176	回零参数	homing_use_z_signal	是否使用z信号	0	0	0	0	1	mm																																																																																																																																																																																																																																																																																																																																																																																																																																																																																																																																																																																																																																																																																																																																																																																																																																																																																																																																																																																																																																																																																																																																																																																																																																																																																																																																												
177	回零参数	homing_use_z_signal	是否使用z信号	0	0	0	0	1	mm																																																																																																																																																																																																																																																																																																																																																																																																																																																																																																																																																																																																																																																																																																																																																																																																																																																																																																																																																																																																																																																																																																																																																																																																																																																																																																																																												
178	回零参数	homing_use_z_signal	是否使用z信号	0	0	0	0	1	mm																																																																																																																																																																																																																																																																																																																																																																																																																																																																																																																																																																																																																																																																																																																																																																																																																																																																																																																																																																																																																																																																																																																																																																																																																																																																																																																																												
179	回零参数	homing_use_z_signal	是否使用z信号	0	0	0	0	1	mm																																																																																																																																																																																																																																																																																																																																																																																																																																																																																																																																																																																																																																																																																																																																																																																																																																																																																																																																																																																																																																																																																																																																																																																																																																																																																																																																												
180	回零参数	homing_use_z_signal	是否使用z信号	0	0	0	0	1	mm																																																																																																																																																																																																																																																																																																																																																																																																																																																																																																																																																																																																																																																																																																																																																																																																																																																																																																																																																																																																																																																																																																																																																																																																																																																																																																																																												
181	回零参数	homing_use_z_signal	是否使用z信号	0	0	0	0	1	mm																																																																																																																																																																																																																																																																																																																																																																																																																																																																																																																																																																																																																																																																																																																																																																																																																																																																																																																																																																																																																																																																																																																																																																																																																																																																																																																																												
182	回零参数	homing_use_z_signal	是否使用z信号	0	0	0	0	1	mm																																																																																																																																																																																																																																																																																																																																																																																																																																																																																																																																																																																																																																																																																																																																																																																																																																																																																																																																																																																																																																																																																																																																																																																																																																																																																																																																												
183	回零参数	homing_use_z_signal	是否使用z信号	0	0	0	0	1	mm																																																																																																																																																																																																																																																																																																																																																																																																																																																																																																																																																																																																																																																																																																																																																																																																																																																																																																																																																																																																																																																																																																																																																																																																																																																																																																																																												
184	回零参数	homing_use_z_signal	是否使用z信号	0	0	0	0	1	mm																																																																																																																																																																																																																																																																																																																																																																																																																																																																																																																																																																																																																																																																																																																																																																																																																																																																																																																																																																																																																																																																																																																																																																																																																																																																																																																																												
185	回零参数	homing_use_z_signal	是否使用z信号	0	0	0	0	1	mm																																																																																																																																																																																																																																																																																																																																																																																																																																																																																																																																																																																																																																																																																																																																																																																																																																																																																																																																																																																																																																																																																																																																																																																																																																																																																																																																												
186	回零参数	homing_use_z_signal	是否使用z信号	0	0	0	0	1	mm																																																																																																																																																																																																																																																																																																																																																																																																																																																																																																																																																																																																																																																																																																																																																																																																																																																																																																																																																																																																																																																																																																																																																																																																																																																																																																																																												
187	回零参数	homing_use_z_signal	是否使用z信号	0	0	0	0	1	mm																																																																																																																																																																																																																																																																																																																																																																																																																																																																																																																																																																																																																																																																																																																																																																																																																																																																																																																																																																																																																																																																																																																																																																																																																																																																																																																																												
188	回零参数	homing_use_z_signal	是否使用z信号	0	0	0	0	1	mm																																																																																																																																																																																																																																																																																																																																																																																																																																																																																																																																																																																																																																																																																																																																																																																																																																																																																																																																																																																																																																																																																																																																																																																																																																																																																																																																												
189	回零参数	homing_use_z_signal	是否使用z信号	0	0	0	0	1	mm																																																																																																																																																																																																																																																																																																																																																																																																																																																																																																																																																																																																																																																																																																																																																																																																																																																																																																																																																																																																																																																																																																																																																																																																																																																																																																																																												
190	回零参数	homing_use_z_signal	是否使用z信号	0	0	0	0	1	mm																																																																																																																																																																																																																																																																																																																																																																																																																																																																																																																																																																																																																																																																																																																																																																																																																																																																																																																																																																																																																																																																																																																																																																																																																																																																																																																																												
191	回零参数	homing_use_z_signal	是否使用z信号	0	0	0	0	1	mm																																																																																																																																																																																																																																																																																																																																																																																																																																																																																																																																																																																																																																																																																																																																																																																																																																																																																																																																																																																																																																																																																																																																																																																																																																																																																																																																												
192	回零参数	homing_use_z_signal	是否使用z信号	0	0	0	0	1	mm																																																																																																																																																																																																																																																																																																																																																																																																																																																																																																																																																																																																																																																																																																																																																																																																																																																																																																																																																																																																																																																																																																																																																																																																																																																																																																																																												
193	回零参数	homing_use_z_signal	是否使用z信号	0	0	0	0	1	mm																																																																																																																																																																																																																																																																																																																																																																																																																																																																																																																																																																																																																																																																																																																																																																																																																																																																																																																																																																																																																																																																																																																																																																																																																																																																																																																																												
194	回零参数	homing_use_z_signal	是否使用z信号	0	0	0	0	1	mm																																																																																																																																																																																																																																																																																																																																																																																																																																																																																																																																																																																																																																																																																																																																																																																																																																																																																																																																																																																																																																																																																																																																																																																																																																																																																																																																												
195	回零参数	homing_use_z_signal	是否使用z信号	0	0	0	0	1	mm																																																																																																																																																																																																																																																																																																																																																																																																																																																																																																																																																																																																																																																																																																																																																																																																																																																																																																																																																																																																																																																																																																																																																																																																																																																																																																																																												
196	回零参数	homing_use_z_signal	是否使用z信号	0	0	0	0	1	mm																																																																																																																																																																																																																																																																																																																																																																																																																																																																																																																																																																																																																																																																																																																																																																																																																																																																																																																																																																																																																																																																																																																																																																																																																																																																																																																																												
197	回零参数	homing_use_z_signal	是否使用z信号	0	0	0	0	1	mm																																																																																																																																																																																																																																																																																																																																																																																																																																																																																																																																																																																																																																																																																																																																																																																																																																																																																																																																																																																																																																																																																																																																																																																																																																																																																																																																												
198	回零参数	homing_use_z_signal	是否使用z信号	0	0	0	0	1	mm																																																																																																																																																																																																																																																																																																																																																																																																																																																																																																																																																																																																																																																																																																																																																																																																																																																																																																																																																																																																																																																																																																																																																																																																																																																																																																																																												
199	回零参数	homing_use_z_signal	是否使用z信号	0	0	0	0	1	mm																																																																																																																																																																																																																																																																																																																																																																																																																																																																																																																																																																																																																																																																																																																																																																																																																																																																																																																																																																																																																																																																																																																																																																																																																																																																																																																																												
200	回零参数	homing_use_z_signal	是否使用z信号	0	0	0	0	1	mm																																																																																																																																																																																																																																																																																																																																																																																																																																																																																																																																																																																																																																																																																																																																																																																																																																																																																																																																																																																																																																																																																																																																																																																																																																																																																																																																												
2、设置参数 limit_switch_polarity = 0(常开型) 或 = 1(常闭型) 根据硬件开关输出极性设置常开型或常闭型。																																																																																																																																																																																																																																																																																																																																																																																																																																																																																																																																																																																																																																																																																																																																																																																																																																																																																																																																																																																																																																																																																																																																																																																																																																																																																																																																																					
3、参数 homing_method = 1 使用限位回零。																																																																																																																																																																																																																																																																																																																																																																																																																																																																																																																																																																																																																																																																																																																																																																																																																																																																																																																																																																																																																																																																																																																																																																																																																																																																																																																																																					
4、参数 homing_use_z_signal = 0 关闭 z 信号辅助回零。																																																																																																																																																																																																																																																																																																																																																																																																																																																																																																																																																																																																																																																																																																																																																																																																																																																																																																																																																																																																																																																																																																																																																																																																																																																																																																																																																					
5、ModePos = 4 使设备运动模式切换到主动回零模式并使能。																																																																																																																																																																																																																																																																																																																																																																																																																																																																																																																																																																																																																																																																																																																																																																																																																																																																																																																																																																																																																																																																																																																																																																																																																																																																																																																																																					
6、CancelTraversing = TRUE 让设备不暂停任务。																																																																																																																																																																																																																																																																																																																																																																																																																																																																																																																																																																																																																																																																																																																																																																																																																																																																																																																																																																																																																																																																																																																																																																																																																																																																																																																																																					
7、IntermediateStop = TRUE 让设备不取消任务。																																																																																																																																																																																																																																																																																																																																																																																																																																																																																																																																																																																																																																																																																																																																																																																																																																																																																																																																																																																																																																																																																																																																																																																																																																																																																																																																																					
8、OverV = 100 速度倍率设定，所有运行模式的速度倍率，值范围：0-199(%)																																																																																																																																																																																																																																																																																																																																																																																																																																																																																																																																																																																																																																																																																																																																																																																																																																																																																																																																																																																																																																																																																																																																																																																																																																																																																																																																																					
9、OverAcc = 100 加速度倍率设定，值范围：0-100(%), 不适用于主动回零、点动及寸动模式																																																																																																																																																																																																																																																																																																																																																																																																																																																																																																																																																																																																																																																																																																																																																																																																																																																																																																																																																																																																																																																																																																																																																																																																																																																																																																																																																					
10、OFF2、OFF3 都设置为 TRUE Control_table 中的 ConfigEpos 的 X0(OFF2),X1(OFF3)设定为 1。																																																																																																																																																																																																																																																																																																																																																																																																																																																																																																																																																																																																																																																																																																																																																																																																																																																																																																																																																																																																																																																																																																																																																																																																																																																																																																																																																					
11、EnableAxis=1 让电机使能。																																																																																																																																																																																																																																																																																																																																																																																																																																																																																																																																																																																																																																																																																																																																																																																																																																																																																																																																																																																																																																																																																																																																																																																																																																																																																																																																																					
12、等待时间 X 确保参数传输完毕，X 应大于 2 倍数据周期时间。 IO 周期时间参考 查看信息																																																																																																																																																																																																																																																																																																																																																																																																																																																																																																																																																																																																																																																																																																																																																																																																																																																																																																																																																																																																																																																																																																																																																																																																																																																																																																																																																					
13、ExecuteMode = TRUE 该信号上升沿时启动任务,设备按照参数表设定的回零参数执行主动回零。																																																																																																																																																																																																																																																																																																																																																																																																																																																																																																																																																																																																																																																																																																																																																																																																																																																																																																																																																																																																																																																																																																																																																																																																																																																																																																																																																					

符号分配详见[符号表分配](#)

8.3.5.1.1.5.5.4.4 硬限位+编码器 z 信号

主动回零模式-使用硬限位信号方式+编码器 z 信号	
步骤	图示
<p>1、参数 limit_protect_enable = 1 使能硬限位功能。</p>	
<p>2、设置参数 limit_switch_polarity = 0(常开型) 或 = 1(常闭型) 根据硬件开关输出极性设置常开型或常闭型。</p>	
<p>3、参数 homing_method = 1 使用限位回零。</p>	
<p>4、参数 homing_use_z_signal = 1 开启 z 信号辅助回零。</p>	
<p>5、ModePos = 4 使设备运动模式切换到主动回零模式并使能。</p>	
<p>6、CancelTraversing = TRUE 让设备不暂停任务。</p>	
<p>7、IntermediateStop = TRUE 让设备不取消任务。</p>	
<p>8、OverV = 100 速度倍率设定，所有运行模式的速度倍率，值范围：0-199(%)</p>	
<p>9、OverAcc = 100 加速度倍率设定，值范围：0-100(%), 不适用于主动回零、点动及寸动模式</p>	
<p>10、OFF2、OFF3 都设置为 TRUE Control_table 中的 ConfigEpos 的 X0(OFF2),X1(OFF3)设定为 1。</p>	
<p>11、EnableAxis=1 让电机使能。</p>	
<p>12、等待时间 X 确保参数传输完毕，X 应大于 2 倍数据周期时间。IO 周期时间参考 查看信息</p>	
<p>13、ExecuteMode = TRUE 该信号上升沿时启动任务,设备按照参数表设定的回零参数执行主动回零。</p>	

符号分配详见[符号表分配](#)

8.3.5.1.1.5.5.5 零点设置模式

零点设置模式	
步骤	图示
1、ModePos = 5 运动模式切换到零点设置模式。	
2、CancelTraversing = TRUE 让设备不暂停任务。	
3、IntermediateStop = TRUE 让设备不取消任务。	
4、OverV = 100 速度倍率设定, 所有运行模式的速度倍率, 值范围: 0-199(%)	
5、OverAcc = 100 加速度倍率设定, 值范围: 0-100(%), 不适用于主动回零、点动及寸动模式	
6、OFF2、OFF3 都设置为 TRUE Control_table 中的 ConfigEpos 的 X0(OFF2),X1(OFF3)设定为 1。	
7、EnableAxis=1 让电机使能。	
8、等待时间 X 确保参数传输完毕, X 应大于 2 倍数据周期时间。 IO 周期时间参考 查看信息	
9、ExecuteMode = TRUE 该信号上升沿时启动任务,设备将当前的位置设置为零点。	

符号分配详见[符号表分配](#)

8.3.5.1.1.5.5.5.1 程序块模式

8.3.5.1.1.5.5.5.2 单次运行模式

程序块模式-单次运行模式																																																																																																																						
步骤	图示																																																																																																																					
1、参数 program_block_operation_mode = 0 程序块运行模式设置为单次运行模式。																																																																																																																						
2、参数 program_block_start_step = 1 程序块起始步设置为 1。																																																																																																																						
3、参数 program_block_end_step = 2 程序块结束步设置为 2。																																																																																																																						
4、参数 program_block_step[1].Xtarget = 0 程序步 1 目标位置设置为 0 lu。	<table border="1"> <thead> <tr> <th>参数号</th> <th>参数名</th> <th>描述</th> <th>设置值</th> <th>初始值</th> <th>出厂值</th> <th>最小值</th> <th>最大值</th> <th>单位</th> </tr> </thead> <tbody> <tr><td>139</td><td>程序步数</td><td>homing_wm_x_target</td><td>z轴机械零点</td><td>10</td><td>10</td><td>0</td><td>0</td><td>mm</td></tr> <tr><td>140</td><td>程序步数</td><td>homing_wm_y_target</td><td>y轴机械零点</td><td>10</td><td>10</td><td>0</td><td>0</td><td>mm</td></tr> <tr><td>141</td><td>程序步数</td><td>homing_wm_z_target</td><td>z轴机械零点</td><td>10</td><td>10</td><td>0</td><td>0</td><td>mm</td></tr> <tr><td>142</td><td>程序步数</td><td>homing_wm_x_offset</td><td>z轴机械零点偏移量</td><td>10</td><td>10</td><td>0</td><td>0</td><td>mm</td></tr> <tr><td>143</td><td>程序步数</td><td>homing_wm_y_offset</td><td>y轴机械零点偏移量</td><td>10</td><td>10</td><td>0</td><td>0</td><td>mm</td></tr> <tr><td>144</td><td>程序步数</td><td>homing_wm_z_offset</td><td>z轴机械零点偏移量</td><td>10</td><td>10</td><td>0</td><td>0</td><td>mm</td></tr> <tr><td>145</td><td>程序步数</td><td>homing_wm_x_start</td><td>z轴机械零点启动时间</td><td>10</td><td>10</td><td>0</td><td>0</td><td>ms</td></tr> <tr><td>146</td><td>程序步数</td><td>homing_wm_y_start</td><td>y轴机械零点启动时间</td><td>10</td><td>10</td><td>0</td><td>0</td><td>ms</td></tr> <tr><td>147</td><td>程序步数</td><td>homing_wm_z_start</td><td>z轴机械零点启动时间</td><td>10</td><td>10</td><td>0</td><td>0</td><td>ms</td></tr> <tr><td>148</td><td>程序步数</td><td>homing_wm_x_end</td><td>z轴机械零点结束时间</td><td>10</td><td>10</td><td>0</td><td>0</td><td>ms</td></tr> <tr><td>149</td><td>程序步数</td><td>homing_wm_y_end</td><td>y轴机械零点结束时间</td><td>10</td><td>10</td><td>0</td><td>0</td><td>ms</td></tr> <tr><td>150</td><td>程序步数</td><td>homing_wm_z_end</td><td>z轴机械零点结束时间</td><td>10</td><td>10</td><td>0</td><td>0</td><td>ms</td></tr> </tbody> </table>	参数号	参数名	描述	设置值	初始值	出厂值	最小值	最大值	单位	139	程序步数	homing_wm_x_target	z轴机械零点	10	10	0	0	mm	140	程序步数	homing_wm_y_target	y轴机械零点	10	10	0	0	mm	141	程序步数	homing_wm_z_target	z轴机械零点	10	10	0	0	mm	142	程序步数	homing_wm_x_offset	z轴机械零点偏移量	10	10	0	0	mm	143	程序步数	homing_wm_y_offset	y轴机械零点偏移量	10	10	0	0	mm	144	程序步数	homing_wm_z_offset	z轴机械零点偏移量	10	10	0	0	mm	145	程序步数	homing_wm_x_start	z轴机械零点启动时间	10	10	0	0	ms	146	程序步数	homing_wm_y_start	y轴机械零点启动时间	10	10	0	0	ms	147	程序步数	homing_wm_z_start	z轴机械零点启动时间	10	10	0	0	ms	148	程序步数	homing_wm_x_end	z轴机械零点结束时间	10	10	0	0	ms	149	程序步数	homing_wm_y_end	y轴机械零点结束时间	10	10	0	0	ms	150	程序步数	homing_wm_z_end	z轴机械零点结束时间	10	10	0	0	ms
参数号	参数名	描述	设置值	初始值	出厂值	最小值	最大值	单位																																																																																																														
139	程序步数	homing_wm_x_target	z轴机械零点	10	10	0	0	mm																																																																																																														
140	程序步数	homing_wm_y_target	y轴机械零点	10	10	0	0	mm																																																																																																														
141	程序步数	homing_wm_z_target	z轴机械零点	10	10	0	0	mm																																																																																																														
142	程序步数	homing_wm_x_offset	z轴机械零点偏移量	10	10	0	0	mm																																																																																																														
143	程序步数	homing_wm_y_offset	y轴机械零点偏移量	10	10	0	0	mm																																																																																																														
144	程序步数	homing_wm_z_offset	z轴机械零点偏移量	10	10	0	0	mm																																																																																																														
145	程序步数	homing_wm_x_start	z轴机械零点启动时间	10	10	0	0	ms																																																																																																														
146	程序步数	homing_wm_y_start	y轴机械零点启动时间	10	10	0	0	ms																																																																																																														
147	程序步数	homing_wm_z_start	z轴机械零点启动时间	10	10	0	0	ms																																																																																																														
148	程序步数	homing_wm_x_end	z轴机械零点结束时间	10	10	0	0	ms																																																																																																														
149	程序步数	homing_wm_y_end	y轴机械零点结束时间	10	10	0	0	ms																																																																																																														
150	程序步数	homing_wm_z_end	z轴机械零点结束时间	10	10	0	0	ms																																																																																																														
5、参数 program_block_step[1].Vtarget = 5000 程序步 1 目标速度设置为 5000 lu/s。																																																																																																																						
6、参数 program_block_step[1].delay = 500 程序步 1 延时设置为 500 ms。																																																																																																																						
7、参数 program_block_step[2].Xtarget = 10000 程序步 2 目标位置设置为 10000 lu。																																																																																																																						
8、参数 program_block_step[2].Vtarget = 5000 程序步 2 目标速度设置为 5000 lu/s。																																																																																																																						
9、参数 program_block_step[2].delay = 500 程序步 2 延时设置为 500 ms。																																																																																																																						
10、ModePos = 6 运动模式切换到程序块模式。 (该模式需要先设定零点)																																																																																																																						
11、CancelTraversing = TRUE 让设备不暂停任务。																																																																																																																						
12、IntermediateStop = TRUE 让设备不取消任务。																																																																																																																						
13、OFF2、OFF3 都设置为 TRUE Control_table 中的 ConfigEpos 的 X0(OFF2),X1(OFF3)设定为 1。																																																																																																																						
14、OverV = 100 速度倍率设定, 所有运行模式的速度倍率, 值范围: 0-199(%)																																																																																																																						
15、OverAcc = 100 加速度倍率设定, 值范围: 0-100(%), 不适用于主动回零、点动及寸动模式																																																																																																																						
16、EnableAxis=1 让电机使能。																																																																																																																						
17、等待时间 X 确保参数传输完毕, X 应大于 2 倍数据周期时间。IO 周期时间参考 查看信息																																																																																																																						
18、ExecuteMode = TRUE 该信号上升沿时启动任务,设备按照程序块参数执行程序块模式运动。																																																																																																																						

参数号	参数名	描述	设置值	初始值	出厂值	最小值	最大值	单位
139	程序步数	homing_wm_x_target	z轴机械零点	10	10	0	0	mm
140	程序步数	homing_wm_y_target	y轴机械零点	10	10	0	0	mm
141	程序步数	homing_wm_z_target	z轴机械零点	10	10	0	0	mm
142	程序步数	homing_wm_x_offset	z轴机械零点偏移量	10	10	0	0	mm
143	程序步数	homing_wm_y_offset	y轴机械零点偏移量	10	10	0	0	mm
144	程序步数	homing_wm_z_offset	z轴机械零点偏移量	10	10	0	0	mm
145	程序步数	homing_wm_x_start	z轴机械零点启动时间	10	10	0	0	ms
146	程序步数	homing_wm_y_start	y轴机械零点启动时间	10	10	0	0	ms
147	程序步数	homing_wm_z_start	z轴机械零点启动时间	10	10	0	0	ms
148	程序步数	homing_wm_x_end	z轴机械零点结束时间	10	10	0	0	ms
149	程序步数	homing_wm_y_end	y轴机械零点结束时间	10	10	0	0	ms
150	程序步数	homing_wm_z_end	z轴机械零点结束时间	10	10	0	0	ms

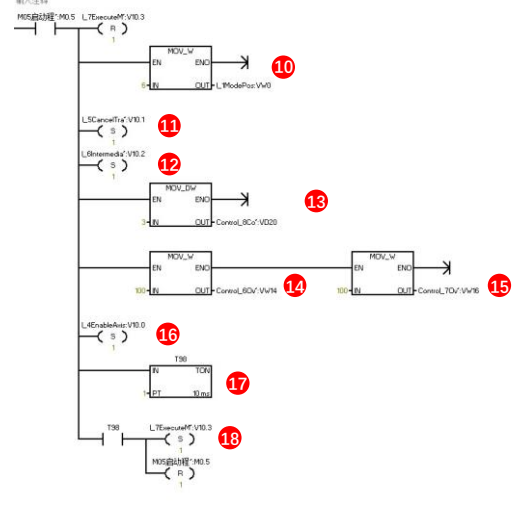

8.3.5.1.1.5.5.3 循环运行模式

程序块模式-循环运行模式	
步骤	图示
1、软件参数 program_block_operation_mode = 1 程序块运行模式设置为循环运行模式。	
2、软件参数 program_block_start_step = 1 程序块起始步设置为 1。	
3、软件参数 program_block_end_step = 2 程序块结束步设置为 2。	
4、软件参数 program_block_step[1].Xtarget = 0 程序步 1 目标位置设置为 0 lu。	
5、软件参数 program_block_step[1].Vtarget = 5000 程序步 1 目标速度设置为 5000 lu/s。	
6、软件参数 program_block_step[1].delay = 500 程序步 1 延时设置为 500 ms。	
7、软件参数 program_block_step[2].Xtarget = 10000 程序步 2 目标位置设置为 10000 lu。	
8、软件参数 program_block_step[2].Vtarget = 5000 程序步 2 目标速度设置为 5000 lu/s。	
9、软件参数 program_block_step[2].delay = 500 程序步 2 延时设置为 500 ms。	
10、ModePos = 6 运动模式切换到程序块模式。	
11、CancelTraversing = TRUE 让设备不暂停任务。	
12、IntermediateStop = TRUE 让设备不取消任务。	
13、OFF2、OFF3 都设置为 TRUE Control_table 中的 ConfigEpos 的 X0(OFF2),X1(OFF3)设定为 1。	
14、OverV = 100 速度倍率设定, 所有运行模式的速度倍率, 值范围: 0-199(%)	
15、OverAcc = 100 加速度倍率设定, 值范围: 0-100(%), 不适用于主动回零、点动及寸动模式	
16、EnableAxis=1 让电机使能。	
17、等待时间 X 确保参数传输完毕, X 应大于 2 倍数据周期时间。IO 周期时间参考 查看信息	
18、ExecuteMode = TRUE 该信号上升沿时启动任务,设备按照程序块参数执行程序块模式运动。	

符号分配详见[符号表分配](#)

8.3.5.1.1.5.5.6 点动模式

点动模式																																																																																																																																																																																																																																																																																																																																																																																																																																					
步骤	图示																																																																																																																																																																																																																																																																																																																																																																																																																																				
<p>1、参数 jog_velocity = 60 设置点动速度为 60rpm。</p>	<table border="1"> <thead> <tr> <th>参数号</th> <th>参数组</th> <th>参数名</th> <th>描述</th> <th>设置值</th> <th>当前值</th> <th>出厂值</th> <th>最小值</th> <th>最大值</th> <th>单位</th> </tr> </thead> <tbody> <tr><td>110</td><td>回零参数</td><td>homing_use_z_signal</td><td>z信号辅助回零</td><td>1=开启</td><td>1</td><td>0</td><td>0</td><td>1</td><td></td></tr> <tr><td>112</td><td>回零参数</td><td>homing_velocity1</td><td>零点搜索速度1</td><td>60</td><td>60</td><td>10</td><td>1</td><td>6000</td><td>rpm</td></tr> <tr><td>114</td><td>回零参数</td><td>homing_velocity2</td><td>零点搜索速度2</td><td>10</td><td>10</td><td>10</td><td>1</td><td>4000</td><td>rpm</td></tr> <tr><td>116</td><td>回零参数</td><td>homing_torque_threshold</td><td>扭矩回零阈值</td><td>98</td><td>98</td><td>98</td><td>1</td><td>100</td><td>%</td></tr> <tr><td>118</td><td>回零参数</td><td>homing_torque_time</td><td>扭矩回零到达驻留时间</td><td>10</td><td>10</td><td>10</td><td>1</td><td>65535</td><td>ms</td></tr> <tr><td>120</td><td>回零参数</td><td>home_offset</td><td>零点搜索完成后偏移距离</td><td>0</td><td>0</td><td>0</td><td>-2147483647</td><td>2147483647</td><td>lu</td></tr> <tr><td>122</td><td></td><td></td><td></td><td></td><td></td><td></td><td></td><td></td><td></td></tr> <tr><td>124</td><td></td><td></td><td></td><td></td><td></td><td></td><td></td><td></td><td></td></tr> <tr><td>126</td><td></td><td></td><td></td><td></td><td></td><td></td><td></td><td></td><td></td></tr> <tr><td>128</td><td></td><td></td><td></td><td></td><td></td><td></td><td></td><td></td><td></td></tr> <tr><td>130</td><td>点动参数</td><td>jog_velocity</td><td>JOG点动速度</td><td>60</td><td>60</td><td>00</td><td>1</td><td></td><td>rpm</td></tr> <tr><td>132</td><td>点动参数</td><td>jog_increase_distance</td><td>JOG可动距离</td><td>-2</td><td>-2</td><td>-2</td><td>-16</td><td>16</td><td>2"m rev</td></tr> <tr><td>134</td><td>程序块参数</td><td>program_block_operation_mode</td><td>程序块运行模式</td><td>1=循环运行模式</td><td>1</td><td>1</td><td>1</td><td>1</td><td></td></tr> <tr><td>136</td><td>程序块参数</td><td>program_block_start_step</td><td>程序块起始步</td><td>1</td><td>1</td><td>1</td><td>1</td><td>1</td><td></td></tr> <tr><td>138</td><td>程序块参数</td><td>program_block_end_step</td><td>程序块结束步</td><td>2</td><td>2</td><td>1</td><td>1</td><td>1</td><td></td></tr> <tr><td>140</td><td>程序块</td><td>program_block_step1].vtarget</td><td>程序步[1]目标位置</td><td>0</td><td>0</td><td>0</td><td>-2147483647</td><td>2147483647</td><td>lu</td></tr> <tr><td>142</td><td>程序块</td><td>program_block_step1].delay</td><td>程序步[1]延迟</td><td>5000</td><td>5000</td><td>1</td><td>1</td><td>2147483647</td><td>lu/s</td></tr> <tr><td>144</td><td>程序块</td><td>program_block_step1].vtarget</td><td>程序步[1]目标速度</td><td>500</td><td>500</td><td>0</td><td>0</td><td>65535</td><td>ms</td></tr> <tr><td>146</td><td>程序块</td><td>program_block_step2].vtarget</td><td>程序步[2]目标位置</td><td>10000</td><td>10000</td><td>0</td><td>-2147483647</td><td>2147483647</td><td>lu/s</td></tr> <tr><td>148</td><td>程序块</td><td>program_block_step2].delay</td><td>程序步[2]延迟</td><td>5000</td><td>5000</td><td>1</td><td>1</td><td>2147483647</td><td>lu/s</td></tr> <tr><td>150</td><td>程序块</td><td>program_block_step2].vtarget</td><td>程序步[2]目标速度</td><td>500</td><td>500</td><td>0</td><td>0</td><td>65535</td><td>ms</td></tr> <tr><td>152</td><td>程序块</td><td>program_block_step3].vtarget</td><td>程序步[3]目标位置</td><td>0</td><td>0</td><td>0</td><td>-2147483647</td><td>2147483647</td><td>lu</td></tr> <tr><td>154</td><td>程序块</td><td>program_block_step3].delay</td><td>程序步[3]延迟</td><td>1</td><td>1</td><td>1</td><td>1</td><td>2147483647</td><td>lu/s</td></tr> <tr><td>156</td><td>程序块</td><td>program_block_step3].vtarget</td><td>程序步[3]目标速度</td><td>0</td><td>0</td><td>0</td><td>0</td><td>65535</td><td>ms</td></tr> <tr><td>158</td><td>程序块</td><td>program_block_step4].vtarget</td><td>程序步[4]目标位置</td><td>0</td><td>0</td><td>0</td><td>-2147483647</td><td>2147483647</td><td>lu/s</td></tr> <tr><td>160</td><td>程序块</td><td>program_block_step4].delay</td><td>程序步[4]延迟</td><td>1</td><td>1</td><td>1</td><td>1</td><td>2147483647</td><td>lu/s</td></tr> <tr><td>162</td><td>程序块</td><td>program_block_step4].vtarget</td><td>程序步[4]目标速度</td><td>0</td><td>0</td><td>0</td><td>0</td><td>65535</td><td>ms</td></tr> <tr><td>164</td><td>程序块</td><td>program_block_step5].vtarget</td><td>程序步[5]目标位置</td><td>0</td><td>0</td><td>0</td><td>-2147483647</td><td>2147483647</td><td>lu/s</td></tr> <tr><td>166</td><td>程序块</td><td>program_block_step5].delay</td><td>程序步[5]延迟</td><td>1</td><td>1</td><td>1</td><td>1</td><td>2147483647</td><td>lu/s</td></tr> <tr><td>168</td><td>程序块</td><td>program_block_step5].vtarget</td><td>程序步[5]目标速度</td><td>0</td><td>0</td><td>0</td><td>0</td><td>65535</td><td>ms</td></tr> <tr><td>170</td><td>程序块</td><td>program_block_step6].vtarget</td><td>程序步[6]目标位置</td><td>0</td><td>0</td><td>0</td><td>-2147483647</td><td>2147483647</td><td>lu</td></tr> <tr><td>172</td><td>程序块</td><td>program_block_step6].delay</td><td>程序步[6]延迟</td><td>1</td><td>1</td><td>1</td><td>1</td><td>2147483647</td><td>lu/s</td></tr> <tr><td>174</td><td>程序块</td><td>program_block_step6].vtarget</td><td>程序步[6]目标速度</td><td>0</td><td>0</td><td>0</td><td>0</td><td>65535</td><td>ms</td></tr> <tr><td>176</td><td>程序块</td><td>program_block_step7].vtarget</td><td>程序步[7]目标位置</td><td>0</td><td>0</td><td>0</td><td>-2147483647</td><td>2147483647</td><td>lu</td></tr> <tr><td>178</td><td>程序块</td><td>program_block_step7].delay</td><td>程序步[7]延迟</td><td>1</td><td>1</td><td>1</td><td>1</td><td>2147483647</td><td>lu/s</td></tr> <tr><td>180</td><td>程序块</td><td>program_block_step7].vtarget</td><td>程序步[7]目标速度</td><td>0</td><td>0</td><td>0</td><td>0</td><td>65535</td><td>ms</td></tr> <tr><td>182</td><td>程序块</td><td>program_block_step8].vtarget</td><td>程序步[8]目标位置</td><td>0</td><td>0</td><td>0</td><td>-2147483647</td><td>2147483647</td><td>lu</td></tr> <tr><td>184</td><td>程序块</td><td>program_block_step8].delay</td><td>程序步[8]延迟</td><td>1</td><td>1</td><td>1</td><td>1</td><td>2147483647</td><td>lu/s</td></tr> <tr><td>186</td><td>程序块</td><td>program_block_step8].vtarget</td><td>程序步[8]目标速度</td><td>0</td><td>0</td><td>0</td><td>0</td><td>65535</td><td>ms</td></tr> <tr><td>188</td><td>程序块</td><td>program_block_step9].vtarget</td><td>程序步[9]目标位置</td><td>0</td><td>0</td><td>0</td><td>-2147483647</td><td>2147483647</td><td>lu</td></tr> <tr><td>190</td><td>程序块</td><td>program_block_step9].delay</td><td>程序步[9]延迟</td><td>1</td><td>1</td><td>1</td><td>1</td><td>2147483647</td><td>lu/s</td></tr> </tbody> </table>	参数号	参数组	参数名	描述	设置值	当前值	出厂值	最小值	最大值	单位	110	回零参数	homing_use_z_signal	z信号辅助回零	1=开启	1	0	0	1		112	回零参数	homing_velocity1	零点搜索速度1	60	60	10	1	6000	rpm	114	回零参数	homing_velocity2	零点搜索速度2	10	10	10	1	4000	rpm	116	回零参数	homing_torque_threshold	扭矩回零阈值	98	98	98	1	100	%	118	回零参数	homing_torque_time	扭矩回零到达驻留时间	10	10	10	1	65535	ms	120	回零参数	home_offset	零点搜索完成后偏移距离	0	0	0	-2147483647	2147483647	lu	122										124										126										128										130	点动参数	jog_velocity	JOG点动速度	60	60	00	1		rpm	132	点动参数	jog_increase_distance	JOG可动距离	-2	-2	-2	-16	16	2"m rev	134	程序块参数	program_block_operation_mode	程序块运行模式	1=循环运行模式	1	1	1	1		136	程序块参数	program_block_start_step	程序块起始步	1	1	1	1	1		138	程序块参数	program_block_end_step	程序块结束步	2	2	1	1	1		140	程序块	program_block_step1].vtarget	程序步[1]目标位置	0	0	0	-2147483647	2147483647	lu	142	程序块	program_block_step1].delay	程序步[1]延迟	5000	5000	1	1	2147483647	lu/s	144	程序块	program_block_step1].vtarget	程序步[1]目标速度	500	500	0	0	65535	ms	146	程序块	program_block_step2].vtarget	程序步[2]目标位置	10000	10000	0	-2147483647	2147483647	lu/s	148	程序块	program_block_step2].delay	程序步[2]延迟	5000	5000	1	1	2147483647	lu/s	150	程序块	program_block_step2].vtarget	程序步[2]目标速度	500	500	0	0	65535	ms	152	程序块	program_block_step3].vtarget	程序步[3]目标位置	0	0	0	-2147483647	2147483647	lu	154	程序块	program_block_step3].delay	程序步[3]延迟	1	1	1	1	2147483647	lu/s	156	程序块	program_block_step3].vtarget	程序步[3]目标速度	0	0	0	0	65535	ms	158	程序块	program_block_step4].vtarget	程序步[4]目标位置	0	0	0	-2147483647	2147483647	lu/s	160	程序块	program_block_step4].delay	程序步[4]延迟	1	1	1	1	2147483647	lu/s	162	程序块	program_block_step4].vtarget	程序步[4]目标速度	0	0	0	0	65535	ms	164	程序块	program_block_step5].vtarget	程序步[5]目标位置	0	0	0	-2147483647	2147483647	lu/s	166	程序块	program_block_step5].delay	程序步[5]延迟	1	1	1	1	2147483647	lu/s	168	程序块	program_block_step5].vtarget	程序步[5]目标速度	0	0	0	0	65535	ms	170	程序块	program_block_step6].vtarget	程序步[6]目标位置	0	0	0	-2147483647	2147483647	lu	172	程序块	program_block_step6].delay	程序步[6]延迟	1	1	1	1	2147483647	lu/s	174	程序块	program_block_step6].vtarget	程序步[6]目标速度	0	0	0	0	65535	ms	176	程序块	program_block_step7].vtarget	程序步[7]目标位置	0	0	0	-2147483647	2147483647	lu	178	程序块	program_block_step7].delay	程序步[7]延迟	1	1	1	1	2147483647	lu/s	180	程序块	program_block_step7].vtarget	程序步[7]目标速度	0	0	0	0	65535	ms	182	程序块	program_block_step8].vtarget	程序步[8]目标位置	0	0	0	-2147483647	2147483647	lu	184	程序块	program_block_step8].delay	程序步[8]延迟	1	1	1	1	2147483647	lu/s	186	程序块	program_block_step8].vtarget	程序步[8]目标速度	0	0	0	0	65535	ms	188	程序块	program_block_step9].vtarget	程序步[9]目标位置	0	0	0	-2147483647	2147483647	lu	190	程序块	program_block_step9].delay	程序步[9]延迟	1	1	1	1	2147483647	lu/s
参数号	参数组	参数名	描述	设置值	当前值	出厂值	最小值	最大值	单位																																																																																																																																																																																																																																																																																																																																																																																																																												
110	回零参数	homing_use_z_signal	z信号辅助回零	1=开启	1	0	0	1																																																																																																																																																																																																																																																																																																																																																																																																																													
112	回零参数	homing_velocity1	零点搜索速度1	60	60	10	1	6000	rpm																																																																																																																																																																																																																																																																																																																																																																																																																												
114	回零参数	homing_velocity2	零点搜索速度2	10	10	10	1	4000	rpm																																																																																																																																																																																																																																																																																																																																																																																																																												
116	回零参数	homing_torque_threshold	扭矩回零阈值	98	98	98	1	100	%																																																																																																																																																																																																																																																																																																																																																																																																																												
118	回零参数	homing_torque_time	扭矩回零到达驻留时间	10	10	10	1	65535	ms																																																																																																																																																																																																																																																																																																																																																																																																																												
120	回零参数	home_offset	零点搜索完成后偏移距离	0	0	0	-2147483647	2147483647	lu																																																																																																																																																																																																																																																																																																																																																																																																																												
122																																																																																																																																																																																																																																																																																																																																																																																																																																					
124																																																																																																																																																																																																																																																																																																																																																																																																																																					
126																																																																																																																																																																																																																																																																																																																																																																																																																																					
128																																																																																																																																																																																																																																																																																																																																																																																																																																					
130	点动参数	jog_velocity	JOG点动速度	60	60	00	1		rpm																																																																																																																																																																																																																																																																																																																																																																																																																												
132	点动参数	jog_increase_distance	JOG可动距离	-2	-2	-2	-16	16	2"m rev																																																																																																																																																																																																																																																																																																																																																																																																																												
134	程序块参数	program_block_operation_mode	程序块运行模式	1=循环运行模式	1	1	1	1																																																																																																																																																																																																																																																																																																																																																																																																																													
136	程序块参数	program_block_start_step	程序块起始步	1	1	1	1	1																																																																																																																																																																																																																																																																																																																																																																																																																													
138	程序块参数	program_block_end_step	程序块结束步	2	2	1	1	1																																																																																																																																																																																																																																																																																																																																																																																																																													
140	程序块	program_block_step1].vtarget	程序步[1]目标位置	0	0	0	-2147483647	2147483647	lu																																																																																																																																																																																																																																																																																																																																																																																																																												
142	程序块	program_block_step1].delay	程序步[1]延迟	5000	5000	1	1	2147483647	lu/s																																																																																																																																																																																																																																																																																																																																																																																																																												
144	程序块	program_block_step1].vtarget	程序步[1]目标速度	500	500	0	0	65535	ms																																																																																																																																																																																																																																																																																																																																																																																																																												
146	程序块	program_block_step2].vtarget	程序步[2]目标位置	10000	10000	0	-2147483647	2147483647	lu/s																																																																																																																																																																																																																																																																																																																																																																																																																												
148	程序块	program_block_step2].delay	程序步[2]延迟	5000	5000	1	1	2147483647	lu/s																																																																																																																																																																																																																																																																																																																																																																																																																												
150	程序块	program_block_step2].vtarget	程序步[2]目标速度	500	500	0	0	65535	ms																																																																																																																																																																																																																																																																																																																																																																																																																												
152	程序块	program_block_step3].vtarget	程序步[3]目标位置	0	0	0	-2147483647	2147483647	lu																																																																																																																																																																																																																																																																																																																																																																																																																												
154	程序块	program_block_step3].delay	程序步[3]延迟	1	1	1	1	2147483647	lu/s																																																																																																																																																																																																																																																																																																																																																																																																																												
156	程序块	program_block_step3].vtarget	程序步[3]目标速度	0	0	0	0	65535	ms																																																																																																																																																																																																																																																																																																																																																																																																																												
158	程序块	program_block_step4].vtarget	程序步[4]目标位置	0	0	0	-2147483647	2147483647	lu/s																																																																																																																																																																																																																																																																																																																																																																																																																												
160	程序块	program_block_step4].delay	程序步[4]延迟	1	1	1	1	2147483647	lu/s																																																																																																																																																																																																																																																																																																																																																																																																																												
162	程序块	program_block_step4].vtarget	程序步[4]目标速度	0	0	0	0	65535	ms																																																																																																																																																																																																																																																																																																																																																																																																																												
164	程序块	program_block_step5].vtarget	程序步[5]目标位置	0	0	0	-2147483647	2147483647	lu/s																																																																																																																																																																																																																																																																																																																																																																																																																												
166	程序块	program_block_step5].delay	程序步[5]延迟	1	1	1	1	2147483647	lu/s																																																																																																																																																																																																																																																																																																																																																																																																																												
168	程序块	program_block_step5].vtarget	程序步[5]目标速度	0	0	0	0	65535	ms																																																																																																																																																																																																																																																																																																																																																																																																																												
170	程序块	program_block_step6].vtarget	程序步[6]目标位置	0	0	0	-2147483647	2147483647	lu																																																																																																																																																																																																																																																																																																																																																																																																																												
172	程序块	program_block_step6].delay	程序步[6]延迟	1	1	1	1	2147483647	lu/s																																																																																																																																																																																																																																																																																																																																																																																																																												
174	程序块	program_block_step6].vtarget	程序步[6]目标速度	0	0	0	0	65535	ms																																																																																																																																																																																																																																																																																																																																																																																																																												
176	程序块	program_block_step7].vtarget	程序步[7]目标位置	0	0	0	-2147483647	2147483647	lu																																																																																																																																																																																																																																																																																																																																																																																																																												
178	程序块	program_block_step7].delay	程序步[7]延迟	1	1	1	1	2147483647	lu/s																																																																																																																																																																																																																																																																																																																																																																																																																												
180	程序块	program_block_step7].vtarget	程序步[7]目标速度	0	0	0	0	65535	ms																																																																																																																																																																																																																																																																																																																																																																																																																												
182	程序块	program_block_step8].vtarget	程序步[8]目标位置	0	0	0	-2147483647	2147483647	lu																																																																																																																																																																																																																																																																																																																																																																																																																												
184	程序块	program_block_step8].delay	程序步[8]延迟	1	1	1	1	2147483647	lu/s																																																																																																																																																																																																																																																																																																																																																																																																																												
186	程序块	program_block_step8].vtarget	程序步[8]目标速度	0	0	0	0	65535	ms																																																																																																																																																																																																																																																																																																																																																																																																																												
188	程序块	program_block_step9].vtarget	程序步[9]目标位置	0	0	0	-2147483647	2147483647	lu																																																																																																																																																																																																																																																																																																																																																																																																																												
190	程序块	program_block_step9].delay	程序步[9]延迟	1	1	1	1	2147483647	lu/s																																																																																																																																																																																																																																																																																																																																																																																																																												
2、ModePos = 7 使设备模式切换到点动模式。																																																																																																																																																																																																																																																																																																																																																																																																																																					
3、CancelTraversing = TRUE 让设备不暂停任务。																																																																																																																																																																																																																																																																																																																																																																																																																																					
4、IntermediateStop = TRUE 让设备不取消任务。																																																																																																																																																																																																																																																																																																																																																																																																																																					
5、OFF2、OFF3 都设置为 TRUE Control_table 中的 ConfigEpos 的 X0(OFF2),X1(OFF3)设定为 1。																																																																																																																																																																																																																																																																																																																																																																																																																																					
6、OverV = 100 速度倍率设定，所有运行模式的速度倍率，值范围：0-199(%)																																																																																																																																																																																																																																																																																																																																																																																																																																					
7、OverAcc = 100 加速度倍率设定，值范围：0-100(%)，不适用于主动回零、点动及寸动模式																																																																																																																																																																																																																																																																																																																																																																																																																																					
8、EnableAxis = TRUE 使能电机。																																																																																																																																																																																																																																																																																																																																																																																																																																					
9、Jog1 = 1 信号为 1 时，设备以 60rpm 的速度向正方向旋转。																																																																																																																																																																																																																																																																																																																																																																																																																																					
10、等待时间 1000ms 电机点动一秒																																																																																																																																																																																																																																																																																																																																																																																																																																					
11、Jog1 = 0 复位正转信号，设备停止正转。																																																																																																																																																																																																																																																																																																																																																																																																																																					

符号分配详见[符号表分配](#)

8.3.5.1.1.5.5.7 寸动模式

寸动模式	
步骤	图示
<p>1、参数 jog_velocity = 60 设置点动速度为 60rpm。(寸动速度=点动速度)</p>	
<p>2、参数 jog_increase_distance = -2 设置寸动距离为-2，即 2 的-2 次方，为 0.25 圈。</p>	
<p>3、ModePos = 8 使设备模式切换到寸动模式。</p>	
<p>4、CancelTraversing = TRUE 让设备不暂停任务。</p>	
<p>5、IntermediateStop = TRUE 让设备不取消任务。</p>	
<p>6、OFF2、OFF3 都设置为 TRUE Control_table 中的 ConfigEpos 的 X0(OFF2),X1(OFF3)设定为 1。</p>	
<p>7、OverV = 100 速度倍率设定，所有运行模式的速度倍率，值范围：0-199(%)</p>	
<p>8、OverAcc = 100 加速度倍率设定，值范围：0-100(%)，不适用于主动回零、点动及寸动模式。</p>	
<p>9、EnableAxis = TRUE 使能电机。</p>	
<p>10、Jog1 = 1 该信号上升沿时启动任务,设备往正方向旋转 0.25 圈。</p>	
<p>11、等待时间 X 确保参数传输完毕，X 应大于 2 倍数据周期时间。 IO 周期时间参考 查看信息</p>	
<p>12、Jog1 = 0 复位正转信号，设备停止正转。</p>	

符号分配详见[符号表分配](#)

8.3.5.1.2 报文 111 使用方法

8.3.5.1.2.1 SINAIPOS

SINAIPOS 是 STEP 7-Micro/WIN SMART 软件中 SINAMICS 库提供的一个功能块，通过西门子报文 111 和设备进行通信。

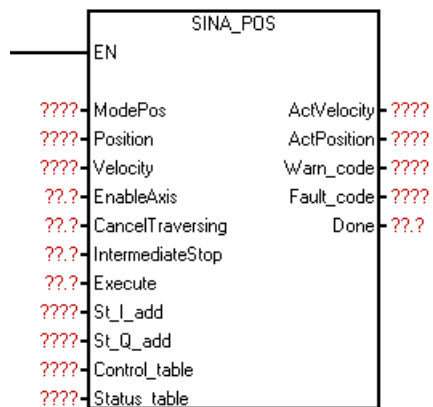

8.3.5.1.2.1.1 输入接口

SINAPOS 的输入接口		
输入信号	类型	含义
ModePos	Int	运动模式: 1=相对位置模式 2=绝对位置模式 3=速度模式 4=主动回零模式 5=零点设置模式 6=程序步模式(暂未兼容) 7=点动模式 8=寸动模式
Position	DINT	位置设定值(LU)
Velocity	DINT	速度设定值(1000LU/min)
EnableAxis	Bool	0 = 停止 (OFF1) 1 = 启动
CancelTraversing	Bool	取消任务: 0=取消当前的运行任务 1=不取消当前的运行任务
IntermediateStop	Bool	暂停任务: 0 = 暂停当前运行任务 1 = 不暂停当前运行任务
Execute	Bool	激活请求的模式
St_I_add	DWORD	被控对象 PROFINET 通信报文 I 区 起始地址的指针 例如&IB128
St_Q_add	DWORD	被控对象 PROFINET 通信报文 Q 区 起始地址的指针 例如&QB128
Control_table	DWORD	控制表起始地址指针, 例如&VD5000
Status_table	DWORD	状态表起始地址指针, 例如&VD4500

8.3.5.1.2.1.2 输出接口

SINAPOS 的输出接口		
输出信号	类型	含义
ActVelocity	DWORD	实际速度 (40000000h 对应 3000rpm)
ActPosition	DWORD	实际位置 (LU)
Warn_conde	WORD	来自设备的警告代码信息
Fault_code	WORD	来自设备的故障代码信息
Done	Bool	当操作模式为相对运动/绝对运动时 目标位置到达信号

8.3.5.1.2.1.3 Control_table 定义

Control_table								
字节偏移	位 7	位 6	位 5	位 4	位 3	位 2	位 1	位 0
0	保留	保留	AckError 确认错误	保留	JOG2 点动 2	JOG1 点动 1	Negative 负向旋转	Positive 正向旋转
1	保留							
2	OverV: 所有运行模式的速度倍率有效: 0-199%							
3								
4	OverAcc: 加速度倍率有效 0-100%, 不适用于主动回零、点动及寸动模式							
5								
6	保留							
7								
8	ConfigEpos							
9								
10								
11								

ConfigEpos 位	功能说明
ConfigEpos.%X0	OFF2 (1 = 无脉冲禁用)
ConfigEpos.%X1	OFF3 (1 = 无斜坡停止)
ConfigEpos.%X2	激活软限位功能(零点设置后生效)
ConfigEpos.%X3	激活硬限位功能(与调试软件中启用硬限位功能互为“或”逻辑, 两者满足其一即生效)
ConfigEpos.%X6	零点开关信号
ConfigEpos.%X8	设定值连续传输 (绝对位置模式、速度模式下有效) 0=单步传输 (通过<启动任务>上升沿接收新的设定值) 1=连续传输 (立即接收新的设定值)

注意: 当程序中对 ConfigEpos 的相关位变量进行配置时, 必须将其初始值设置为 3 (ConfigEpos.%X0 = 1, ConfigEpos.%X1 = 1), 以确保 OFF2 和 OFF3 停止功能处于非禁用与停止状态。

8.3.5.1.2.1.4 Status_table 定义

Status_table								
字节偏移	位 7	位 6	位 5	位 4	位 3	位 2	位 1	位 0
0	保留	Overrange_Error 输入的数据超出 范围	AxisError 驱动器发生 错误	AxisWarn 驱动器发生 警告	Lockout 驱动器禁止 接通	AxisRef 已设置参考 点	AxisPosOk 达到轴的目 标位置	Axisenabled 驱动已使能
1	ErrorID:错误							
2	Actmode:当前激活的运行模式							
3								
4	POS_ZSW1:POS ZSW1 状态字							
5								
6	POS_ZSW2:POS ZSW2 状态字							
7								

错误代码	说明
0	无错误
1	检测到驱动器错误
2	驱动器已禁用
3	不支持所选模式
4	参数 OverV、OverAcc、OverDec 的设置超出支持的取值范围
5	ModePos=6 时，设置的程序段号超出范围

9 诊断

9.1 说明

警告\报警\故障 可通过输入报文的 状态 查看，也可通过配置软件查看。

通过报文查看警告\报警\故障					在配置软件查看警告\报警\故障																																																																																																																																																																																																												
<table border="1"><thead><tr><th>名称</th><th>数据类型</th><th>起始值</th><th>监视值</th><th>保持</th></tr></thead><tbody><tr><td>MD42_DB</td><td></td><td></td><td></td><td></td></tr><tr><td>in</td><td>Struct</td><td></td><td></td><td></td></tr><tr><td> _0_XEncoder_transform</td><td>DInt</td><td>0</td><td>995595</td><td></td></tr><tr><td> _1_VEncoder_transform</td><td>DInt</td><td>0</td><td>0</td><td></td></tr><tr><td> _2_payload</td><td>DInt</td><td>0</td><td>0</td><td></td></tr><tr><td> _3_following_error</td><td>DInt</td><td>0</td><td>0</td><td></td></tr><tr><td> 4_state_bits</td><td>Struct</td><td></td><td></td><td></td></tr><tr><td> _24_fault_emergency_stop_ac...</td><td>Bool</td><td>false</td><td>FALSE</td><td></td></tr><tr><td> _25_fault_excessive_following...</td><td>Bool</td><td>false</td><td>FALSE</td><td></td></tr><tr><td> _26_fault_stall</td><td>Bool</td><td>false</td><td>FALSE</td><td></td></tr><tr><td> _27_fault_no_calibration</td><td>Bool</td><td>false</td><td>FALSE</td><td></td></tr><tr><td> _28_fault_drv_stga</td><td>Bool</td><td>false</td><td>FALSE</td><td></td></tr><tr><td> _29_fault_drv_stgb</td><td>Bool</td><td>false</td><td>FALSE</td><td></td></tr><tr><td> _30_fault_drv_ot</td><td>Bool</td><td>false</td><td>FALSE</td><td></td></tr><tr><td> _31_execute_mode</td><td>Bool</td><td>false</td><td>FALSE</td><td></td></tr><tr><td> _16_warn_not_homed</td><td>Bool</td><td>false</td><td>FALSE</td><td></td></tr><tr><td> _17_warn_positive_limit_switc...</td><td>Bool</td><td>false</td><td>FALSE</td><td></td></tr><tr><td> _18_warn_negative_limit_switc...</td><td>Bool</td><td>false</td><td>FALSE</td><td></td></tr><tr><td> _19_warn_soft_positive_limit_...</td><td>Bool</td><td>false</td><td>FALSE</td><td></td></tr><tr><td> _20_warn_soft_negative_limit_...</td><td>Bool</td><td>false</td><td>FALSE</td><td></td></tr><tr><td> _21_warn_drv_otpw</td><td>Bool</td><td>false</td><td>FALSE</td><td></td></tr><tr><td> _22</td><td>Bool</td><td>false</td><td>FALSE</td><td></td></tr><tr><td> _23_alarm_limit_approached</td><td>Bool</td><td>false</td><td>FALSE</td><td></td></tr><tr><td> _09_negative_limit_switch_act...</td><td>Bool</td><td>false</td><td>TRUE</td><td></td></tr><tr><td> _10_emergency_stop_switch_...</td><td>Bool</td><td>false</td><td>TRUE</td><td></td></tr><tr><td> _11_homing</td><td>Bool</td><td>false</td><td>FALSE</td><td></td></tr><tr><td> _12_homed</td><td>Bool</td><td>false</td><td>TRUE</td><td></td></tr><tr><td> _13</td><td>Bool</td><td>false</td><td>FALSE</td><td></td></tr><tr><td> _14</td><td>Bool</td><td>false</td><td>FALSE</td><td></td></tr><tr><td> _15</td><td>Bool</td><td>false</td><td>FALSE</td><td></td></tr><tr><td> _00_enabled</td><td>Bool</td><td>false</td><td>TRUE</td><td></td></tr><tr><td> _01_ramp_position_reached</td><td>Bool</td><td>false</td><td>TRUE</td><td></td></tr><tr><td> _02_ramp_velocity_reached</td><td>Bool</td><td>false</td><td>FALSE</td><td></td></tr><tr><td> _03_axis_position_reached</td><td>Bool</td><td>false</td><td>TRUE</td><td></td></tr><tr><td> _04_axis_velocity_reached</td><td>Bool</td><td>false</td><td>FALSE</td><td></td></tr><tr><td> _05_axis_standstill</td><td>Bool</td><td>false</td><td>TRUE</td><td></td></tr><tr><td> _06</td><td>Bool</td><td>false</td><td>FALSE</td><td></td></tr><tr><td> _07</td><td>Bool</td><td>false</td><td>FALSE</td><td></td></tr><tr><td> _5_homing_state_code</td><td>DInt</td><td>0</td><td>0</td><td></td></tr></tbody></table>					名称	数据类型	起始值	监视值	保持	MD42_DB					in	Struct				_0_XEncoder_transform	DInt	0	995595		_1_VEncoder_transform	DInt	0	0		_2_payload	DInt	0	0		_3_following_error	DInt	0	0		4_state_bits	Struct				_24_fault_emergency_stop_ac...	Bool	false	FALSE		_25_fault_excessive_following...	Bool	false	FALSE		_26_fault_stall	Bool	false	FALSE		_27_fault_no_calibration	Bool	false	FALSE		_28_fault_drv_stga	Bool	false	FALSE		_29_fault_drv_stgb	Bool	false	FALSE		_30_fault_drv_ot	Bool	false	FALSE		_31_execute_mode	Bool	false	FALSE		_16_warn_not_homed	Bool	false	FALSE		_17_warn_positive_limit_switc...	Bool	false	FALSE		_18_warn_negative_limit_switc...	Bool	false	FALSE		_19_warn_soft_positive_limit_...	Bool	false	FALSE		_20_warn_soft_negative_limit_...	Bool	false	FALSE		_21_warn_drv_otpw	Bool	false	FALSE		_22	Bool	false	FALSE		_23_alarm_limit_approached	Bool	false	FALSE		_09_negative_limit_switch_act...	Bool	false	TRUE		_10_emergency_stop_switch_...	Bool	false	TRUE		_11_homing	Bool	false	FALSE		_12_homed	Bool	false	TRUE		_13	Bool	false	FALSE		_14	Bool	false	FALSE		_15	Bool	false	FALSE		_00_enabled	Bool	false	TRUE		_01_ramp_position_reached	Bool	false	TRUE		_02_ramp_velocity_reached	Bool	false	FALSE		_03_axis_position_reached	Bool	false	TRUE		_04_axis_velocity_reached	Bool	false	FALSE		_05_axis_standstill	Bool	false	TRUE		_06	Bool	false	FALSE		_07	Bool	false	FALSE		_5_homing_state_code	DInt	0	0						
名称	数据类型	起始值	监视值	保持																																																																																																																																																																																																													
MD42_DB																																																																																																																																																																																																																	
in	Struct																																																																																																																																																																																																																
_0_XEncoder_transform	DInt	0	995595																																																																																																																																																																																																														
_1_VEncoder_transform	DInt	0	0																																																																																																																																																																																																														
_2_payload	DInt	0	0																																																																																																																																																																																																														
_3_following_error	DInt	0	0																																																																																																																																																																																																														
4_state_bits	Struct																																																																																																																																																																																																																
_24_fault_emergency_stop_ac...	Bool	false	FALSE																																																																																																																																																																																																														
_25_fault_excessive_following...	Bool	false	FALSE																																																																																																																																																																																																														
_26_fault_stall	Bool	false	FALSE																																																																																																																																																																																																														
_27_fault_no_calibration	Bool	false	FALSE																																																																																																																																																																																																														
_28_fault_drv_stga	Bool	false	FALSE																																																																																																																																																																																																														
_29_fault_drv_stgb	Bool	false	FALSE																																																																																																																																																																																																														
_30_fault_drv_ot	Bool	false	FALSE																																																																																																																																																																																																														
_31_execute_mode	Bool	false	FALSE																																																																																																																																																																																																														
_16_warn_not_homed	Bool	false	FALSE																																																																																																																																																																																																														
_17_warn_positive_limit_switc...	Bool	false	FALSE																																																																																																																																																																																																														
_18_warn_negative_limit_switc...	Bool	false	FALSE																																																																																																																																																																																																														
_19_warn_soft_positive_limit_...	Bool	false	FALSE																																																																																																																																																																																																														
_20_warn_soft_negative_limit_...	Bool	false	FALSE																																																																																																																																																																																																														
_21_warn_drv_otpw	Bool	false	FALSE																																																																																																																																																																																																														
_22	Bool	false	FALSE																																																																																																																																																																																																														
_23_alarm_limit_approached	Bool	false	FALSE																																																																																																																																																																																																														
_09_negative_limit_switch_act...	Bool	false	TRUE																																																																																																																																																																																																														
_10_emergency_stop_switch_...	Bool	false	TRUE																																																																																																																																																																																																														
_11_homing	Bool	false	FALSE																																																																																																																																																																																																														
_12_homed	Bool	false	TRUE																																																																																																																																																																																																														
_13	Bool	false	FALSE																																																																																																																																																																																																														
_14	Bool	false	FALSE																																																																																																																																																																																																														
_15	Bool	false	FALSE																																																																																																																																																																																																														
_00_enabled	Bool	false	TRUE																																																																																																																																																																																																														
_01_ramp_position_reached	Bool	false	TRUE																																																																																																																																																																																																														
_02_ramp_velocity_reached	Bool	false	FALSE																																																																																																																																																																																																														
_03_axis_position_reached	Bool	false	TRUE																																																																																																																																																																																																														
_04_axis_velocity_reached	Bool	false	FALSE																																																																																																																																																																																																														
_05_axis_standstill	Bool	false	TRUE																																																																																																																																																																																																														
_06	Bool	false	FALSE																																																																																																																																																																																																														
_07	Bool	false	FALSE																																																																																																																																																																																																														
_5_homing_state_code	DInt	0	0																																																																																																																																																																																																														

9.2 警告列表

警告	原因	处理
未回零点(零点未设置)	通电启动后, 零点还未被设定。	1、运动模式切换为主动回零模式并启动, 按照参数表的回零参数设置进行零点设置。 2、运动模式切换为零点设置模式并启动, 设备将当前的位置设置为零点。
到达正限位	参数<硬限位保护功能>使能时, 同时电机正转运动过程中激活正限位开关时, 会触发该警告。	电机反转运动直到产生正限位下降沿后, 警告解除。
到达负限位	参数<硬限位保护功能>使能时, 同时电机反转运动过程中激活负限位开关时, 会触发该警告。	电机正转运动直到产生负限位下降沿后, 警告解除。
到达软正限位	参数<软限位保护功能>使能时, 同时电机正转运动过程中, 位置大于参数 软正限位设置值时, 会触发该警告。	电机反转运动直到当前位置小于参数 软正限位设置值后, 警告解除。
到达软负限位	参数<软限位保护功能>使能时, 同时电机反转运动过程中, 位置小于 参数 软负限位设置值时, 会触发该警告。	电机正转运动直到当前位置大于参数 软负限位设置值后, 警告解除。
驱动电路高温预警(120°C)	电机扭矩与实际需求不匹配(长时间满载运行)或堵转导致电机驱动电路温度超过 120 摄氏度时会触发该警告(该警告虽不直接影响设备运行, 但长时间过温会导致设备寿命缩短或损坏)	电机扭矩与实际需求不匹配时, 建议更换更大扭矩的设备。
电机未校准	通常不会出现此状态。设备编码器与电机的校准丢失。	联系厂家。

9.3 报警列表

报警	原因	处理
到达(软/硬限位)	参数 硬限位保护功能/软限位保护功能使能时, 当触发了限位警告时, 该信号会被置位, 同时停止电机运动。	通过输入报文确认错误 out_3_control_bits_08_ack_error 上升沿确认错误 或 通过软件 '确认错误' 按钮解除报警。

9.4 故障列表

故障	原因	处理
急停激活	参数<急停功能>使能时, 当 ESTOP (紧急停止) 开关信号激活时, 急停激活故障会被置位。	1、解除 ESTOP (紧急停止) 开关信号。 2、通过输入报文 out_3_control_bits_08_ack_error 上升沿解除或 通过软件" 确认错误" 按钮解除报警。
跟随误差过大	参数<跟随误差监视>使能时, 当跟踪误差超出参数所设置的阈值时, 跟随误差过大故障会被置位。	1、通过输入报文 out_3_control_bits_08_ack_error 上升沿解除报警 或 通过软件" 确认错误" 按钮解除报警。 2、假如不是因为堵转而产生此错误, 可以尝试加大跟随误差阈值 1 和跟随误差阈值 2。
堵转错误	参数<堵转保护>使能时, 当电机的负载超出参数所设置的阈值时, 堵转错误故障会被置位。	1、通过输入报文 out_3_control_bits_08_ack_error 上升沿解除报警 或 通过软件" 确认错误" 按钮解除报警。 2、假如不是因为堵转而产生此错误, 可以尝试加大堵转保护相关参数。
未校准电机	电机编码器校准数据丢失。	联系厂家。
电机 A 相对地短路	检测到电机 A 相绕组短路。	联系厂家。
电机 B 相对地短路	检测到电机 B 相绕组短路。	联系厂家。
驱动电路过温保护(150°C)	电机扭矩与实际需求不匹配(长时间满载运行)或堵转导致电机驱动电路温度超过 150 摄氏度时会触发该故障。	1、电机扭矩与实际需求不匹配时, 建议更换更大扭矩的设备。 2、设定 PXX 电流降额 = 1 至 5, 降低最大输出电流。

10 参数表

10.1 基本参数

寄存器号	数据类型	名称	出厂值	最小值	最大值	单位	修改方式	生效方式
10	i32	calibration_mode_torque_limit	60	1	100	%	直接修改	立即生效
	校准模式转矩限制 限制校准模式下的最大允许输出转矩。（仅厂家使用）							
12	i32	normal_mode_torque_limit	100	1	100	%	直接修改	立即生效
	常规模式转矩限制 限制常规模式下的最大允许输出转矩。							
14	i32	velocity_limit	3000	1	6000	rpm	直接修改	立即生效
	速度限制 限制目标速度设定值的最大允许值。							
16	i32	acceleration_limit	76800000	1	76800000	rpm ²	直接修改	立即生效
	加速度限制 限制加速度设定值的最大允许值。							
18	i32	acceleration	768000	1	76800000	rpm ²	直接修改	立即生效
	加速度 加速度设定值。							
20	i32	lu	10000	1	1048576	lu	直接修改	立即生效
	负载每圈 LU 数 负载每旋转一圈的位置单位数。相当于“每圈脉冲数”。							
22	i32	gear_ratio_n1	1	1	1048576	-	直接修改	立即生效
	齿轮比 n1 减速机电机侧转数。							

24	i32	gear_ratio_n2	1	1	1048576	-	直接修改	立即生效
	齿轮比 n2 减速箱负载侧转数。							
26	i32	velocity_lpf_exp	5	1	8	$1/2^n$	直接修改	立即生效
	速度滤波指数 值越大，速度反馈越平滑，响应速度越慢。							
28	i32	invert_direction	0	0	1	-	直接修改	下次使能生效
	取反运动方向 0=不取反 1=取反							
30	i32	-	-	-	-	-	-	-
	【预留】							
32	i32	-	-	-	-	-	-	-
	【预留】							

10.2 闭环控制参数

寄存器号	数据类型	名称	出厂值	最小值	最大值	单位	修改方式	生效方式
34	i32	controller_preferences	3	0	7	-	直接修改	立即生效
	控制器偏好 值越小，位置跟踪精度越高； 值越大，速度跟踪精度越高；							
36	i32	ladrc_bandwidth	240	100	1200	hz	直接修改	立即生效
	LADRC 带宽 带宽越低，电机动态响应越慢，同时速度噪声越小。 带宽越高，电机动态响应越快，同时速度噪声越大。							
38	i32	ladrc_b0	45000	1	2147483647	-	直接修改	立即生效
	LADRC 被控系统系数 b0 可根据负载大小来调节，一般情况下在 30000-150000 之间。							
40	i32	torque_ffw	150	0	65535	%	直接修改	立即生效
	转矩前馈 转矩前馈比例越大，加速或减速时的前馈补偿量越大。							
42	i32	dynamic_bandwidth_enable	1	0	1	-	直接修改	立即生效
	LADRC 动态带宽使能 0=关闭 1=开启							
44	i32	dynamic_bandwidth	400	100	1200	hz	直接修改	立即生效
	LADRC 动态带宽 建议取值比 ladrc_bandwidth 大 1.5 倍至 2 倍。							

10.3 弱磁控制参数

10.3.1 MD42 系列

寄存器号	数据类型	名称	出厂值	最小值	最大值	单位	修改方式	生效方式
46	i32	fw_velocity	300	1	6000	rpm	直接修改	立即生效
	弱磁介入速度 一般为 200RPM-400RPM 开始弱磁。							
48	i32	fw_gain	5500	1	65535	1/n	直接修改	立即生效
	弱磁增益 该增益为倒数，值越大，增益越小。							

10.3.2 MD57 系列

寄存器号	数据类型	名称	出厂值	最小值	最大值	单位	修改方式	生效方式
46	i32	fw_velocity	100	1	6000	rpm	直接修改	立即生效
	弱磁介入速度 一般为 200RPM-400RPM 开始弱磁。							
48	i32	fw_gain	5500	1	65535	1/n	直接修改	立即生效
	弱磁增益 该增益为倒数，值越大，增益越小。							

10.4 电流控制参数

10.4.1 MD42 系列

寄存器号	数据类型	名称	出厂值	最小值	最大值	单位	修改方式	生效方式
50	i32	chopper_toff	3	2	4	-	直接修改	重启生效
	电流控制器 慢衰减时间 电流控制器的慢衰减时间。							
52	i32	chopper_hstrt	2	0	7	-	直接修改	重启生效
	电流控制器 迟滞窗口上限 电流控制器的迟滞窗口上限。							
54	i32	chopper_hend	4	0	11	-	直接修改	重启生效
	电流控制器 迟滞窗口下限 电流控制器的迟滞窗口下限。							
56	i32	chopper_tbl	2	0	3	-	直接修改	重启生效
	电流控制器 电流采样消影时间 电流控制器的电流采样消影时间。							
58	i32	current_derating	0	0	5	-	直接修改	重启生效
	电流降额 0=不降额 1-5 表示降额 10%-50%							
60	i32	-	-	-	-	-	-	-
	【预留】							

10.4.2 MD57 系列

寄存器号	数据类型	名称	出厂值	最小值	最大值	单位	修改方式	生效方式
50	i32	chopper_wc	1500	1000	4000	hz	直接修改	立即生效
	电流控制器 带宽 电流控制器的带宽。							
52	i32	chopper_wc_1000rpm	2000	1000	4000	hz	直接修改	立即生效
	电流控制器 1000RPM 时的带宽 电流控制器在电机转速为 1000RPM 时的带宽。							
54	i32	chopper_zeta	80	1	100	%	直接修改	立即生效
	电流控制器 阻尼比 电流控制器的阻尼比，用于实时计算 Kp 和 Ki。							
56	i32	chopper_tbl	2	0	3	-	直接修改	立即生效
	电流控制器 电流采样消影时间 电流控制器的电流采样消影时间。							
58	i32	chopper_deadtime_comp	2	0	3	-	直接修改	立即生效
	电流控制器 死区时间补偿 电流控制器的死区时间补偿量选择。							
60	i32	-	-	-	-	-	-	-
	【预留】							

10.5 信号参数

寄存器号	数据类型	名称	出厂值	最小值	最大值	单位	修改方式	生效方式
62	i32	target_reached_threshold	-10	-16	16	2^N rev	直接修改	立即生效
	位置到达阈值 该参数请查表设定。							
64	i32	target_reached_time	10	1	65535	ms	直接修改	立即生效
	位置到达驻留时间 在位置到达阈值后需要保持的时间。							
66	i32	velocity_reached_threshold	10	1	6000	rpm	直接修改	立即生效
	速度到达阈值 定义速度到达的阈值。							
68	i32	velocity_reached_time	10	1	65535	ms	直接修改	立即生效
	速度到达驻留时间 在速度到达阈值后需要保持的时间。							
70	i32	standstill_threshold	2	1	6000	rpm	直接修改	立即生效
	零速阈值 定义零速状态的阈值。							
72	i32	standstill_time	10	1	65535	ms	直接修改	立即生效
	零速驻留时间 在零速状态下需要保持的时间。							

10.6 保护功能参数

寄存器号	数据类型	名称	出厂值	最小值	最大值	单位	修改方式	生效方式
74	i32	following_error_monitoring_enable	1	0	1	-	直接修改	立即生效
	跟随误差监视使能 0=关闭 1=开启							
76	i32	following_error_threshold1	-6	-16	16	2 ⁿ rev	直接修改	立即生效
	跟随误差阈值 1 速度为零时，容许跟随误差的阈值。							
78	i32	following_error_threshold2	-2	-16	16	2 ⁿ rev	直接修改	立即生效
	跟随误差阈值 2 最大速度时 (velocity_limit) 容许跟随误差的阈值。							
80	i32	following_error_time	1000	1	65535	ms	直接修改	立即生效
	跟随误差过大驻留时间 跟随误差超过阈值后需要保持的时间。							
82	i32	stall_protect_enable	0	0	1	-	直接修改	立即生效
	堵转保护使能 0=关闭 1=开启							
84	i32	stall_protect_velocity_threshold	2	1	6000	rpm	直接修改	立即生效
	堵转保护速度阈值							

寄存器号	数据类型	名称	出厂值	最小值	最大值	单位	修改方式	生效方式
86	i32	stall_protect_torque_threshold	98	1	100	%	直接修改	立即生效
	堵转保护转矩阈值							
88	i32	stall_protect_time	1000	1	65535	ms	直接修改	立即生效
	堵转保护时间							
90	i32	limit_protect_enable	0	0	1	-	直接修改	立即生效
	硬限位保护使能 0=关闭 1=开启							
92	i32	limit_switch_polarity	1	0	1	-	直接修改	立即生效
	硬限位信号极性 0=常开型信号 1=常闭型信号							
94	i32	limit_switch_swap	0	0	1	-	直接修改	立即生效
	硬限位交换 0=关闭 1=开启							
96	i32	soft_limit_protect_enable	0	0	1	-	直接修改	立即生效
	软限位保护使能 0=关闭 1=开启							

寄存器号	数据类型	名称	出厂值	最小值	最大值	单位	修改方式	生效方式
98	i32	soft_positive_limit	0	-2147483647	2147483647	lu	直接修改	立即生效
	软正限位 软正限位的位置。							
100	i32	soft_negative_limit	0	-2147483647	2147483647	lu	直接修改	立即生效
	软负限位 软负限位的位置。							
102	i32	emergency_stop_enable	0	0	1	-	直接修改	立即生效
	急停功能使能 0=关闭 1=开启							
104	i32	-	-	-	-	-	-	-
	【预留】							

10.7 回零参数组

寄存器号	数据类型	名称	出厂值	最小值	最大值	单位	修改方式	生效方式
106	i32	homing_method	0	0	1	-	直接修改	立即生效
	零点搜索方法 0=扭矩回零 1=限位回零							
108	i32	homing_dir	0	0	1	-	直接修改	立即生效
	零点搜索方向 0=往负方向 1=往正方向							
110	i32	homing_use_z_signal	1	0	1	-	直接修改	立即生效
	z 信号辅助回零 是否使用编码器的零位脉冲信号进行辅助回零。 0=关闭 1=开启							
112	i32	homing_velocity1	60	1	6000	rpm	直接修改	立即生效
	零点搜索速度 1 第一阶段的零点搜索速度。							
114	i32	homing_velocity2	10	1	6000	rpm	直接修改	立即生效
	零点搜索速度 2 第二阶段的零点搜索速度。							
116	i32	homing_torque_threshold	98	1	100	%	直接修改	立即生效
	扭矩回零阈值 扭矩回零的负载阈值。							
118	i32	homing_torque_time	10	1	65535	ms	直接修改	立即生效
	扭矩阈值到达驻留时间 在扭矩回零时，负载阈值到达后需要保持的时间。							

寄存器号	数据类型	名称	出厂值	最小值	最大值	单位	修改方式	生效方式
120	i32	home_offset	0	-2147483647	2147483647	lu	直接修改	立即生效
	零点搜索完成后偏移距离 完成零点搜索后的偏移距离。							
122	i32	-	-	-	-	-	-	-
	【预留】							
124	i32	-	-	-	-	-	-	-
	【预留】							
126	i32	-	-	-	-	-	-	-
	【预留】							
128	i32	-	-	-	-	-	-	-
	【预留】							

10.8 点动参数组

寄存器号	数据类型	名称	出厂值	最小值	最大值	单位	修改方式	生效方式
130	i32	jog_velocity	60	1	6000	rpm	直接修改	立即生效
	JOG 点动速度							
132	i32	jog_increase_distance	-2	-16	16	2^n rev	直接修改	立即生效
	JOG 寸动距离 设定值定义参考章节 《点动功能》							

10.9 程序块参数组

寄存器号	数据类型	名称	出厂值	最小值	最大值	单位	修改方式	生效方式
134	i32	program_block_operation_mode	0	0	1	-	直接修改	立即生效
	程序块运行模式 0=单次运行模式 1=循环运行模式							
136	i32	program_block_start_step	1	1	16	-	直接修改	立即生效
	程序块起始步							
138	i32	program_block_end_step	1	1	16	-	直接修改	立即生效
	程序块结束步							

10.10 程序块组

参数号 P	数据类型	名称	出厂值	最小值	最大值	单位	修改方式	生效方式
140	i32	program_block_step[1].Xtarget	0	-2147483647	2147483647	lu	直接修改	立即生效
	程序步[1].目标位置 程序步[n].目标位置: 每个步骤的目标位置。							
142	i32	program_block_step[1].Vtarget	1	1	2147483647	lu/s	直接修改	立即生效
	程序步[1].目标速度 程序步[n].目标速度: 每个步骤的目标速度。							
144	i32	program_block_step[1].delay	0	0	65535	ms	直接修改	立即生效
	程序步[1].延时 程序步[n].延时: 每个步骤之间的延时。							
146	i32	program_block_step[2].Xtarget	0	-2147483647	2147483647	lu	直接修改	立即生效
	程序步[2].目标位置							
148	i32	program_block_step[2].Vtarget	1	1	2147483647	lu/s	直接修改	立即生效
	程序步[2].目标速度							
150	i32	program_block_step[2].delay	0	0	65535	ms	直接修改	立即生效
	程序步[2].延时							
152	i32	program_block_step[3].Xtarget	0	-2147483647	2147483647	lu	直接修改	立即生效
	程序步[3].目标位置							
154	i32	program_block_step[3].Vtarget	1	1	2147483647	lu/s	直接修改	立即生效
	程序步[3].目标速度							

参数号 P	数据类型	名称	出厂值	最小值	最大值	单位	修改方式	生效方式
156	i32	program_block_step[3].delay	0	0	65535	ms	直接修改	立即生效
	程序步[3].延时							
158	i32	program_block_step[4].Xtarget	0	-2147483647	2147483647	lu	直接修改	立即生效
	程序步[4].目标位置							
160	i32	program_block_step[4].Vtarget	1	1	2147483647	lu/s	直接修改	立即生效
	程序步[4].目标速度							
162	i32	program_block_step[4].delay	0	0	65535	ms	直接修改	立即生效
	程序步[4].延时							
164	i32	program_block_step[5].Xtarget	0	-2147483647	2147483647	lu	直接修改	立即生效
	程序步[5].目标位置							
166	i32	program_block_step[5].Vtarget	1	1	2147483647	lu/s	直接修改	立即生效
	程序步[5].目标速度							
168	i32	program_block_step[5].delay	0	0	65535	ms	直接修改	立即生效
	程序步[5].延时							
170	i32	program_block_step[6].Xtarget	0	-2147483647	2147483647	lu	直接修改	立即生效
	程序步[6].目标位置							
172	i32	program_block_step[6].Vtarget	1	1	2147483647	lu/s	直接修改	立即生效
	程序步[6].目标速度							

参数号 P	数据类型	名称	出厂值	最小值	最大值	单位	修改方式	生效方式
174	i32	program_block_step[6].delay	0	0	65535	ms	直接修改	立即生效
	程序步[6].延时							
176	i32	program_block_step[7].Xtarget	0	-2147483647	2147483647	lu	直接修改	立即生效
	程序步[7].目标位置							
178	i32	program_block_step[7].Vtarget	1	1	2147483647	lu/s	直接修改	立即生效
	程序步[7].目标速度							
180	i32	program_block_step[7].delay	0	0	65535	ms	直接修改	立即生效
	程序步[7].延时							
182	i32	program_block_step[8].Xtarget	0	-2147483647	2147483647	lu	直接修改	立即生效
	程序步[8].目标位置							
184	i32	program_block_step[8].Vtarget	1	1	2147483647	lu/s	直接修改	立即生效
	程序步[8].目标速度							
186	i32	program_block_step[8].delay	0	0	65535	ms	直接修改	立即生效
	程序步[8].延时							
188	i32	program_block_step[9].Xtarget	0	-2147483647	2147483647	lu	直接修改	立即生效
	程序步[9].目标位置							
190	i32	program_block_step[9].Vtarget	1	1	2147483647	lu/s	直接修改	立即生效

参数号 P	数据类型	名称	出厂值	最小值	最大值	单位	修改方式	生效方式
		程序步[9].目标速度						
192	i32	program_block_step[9].delay	0	0	65535	ms	直接修改	立即生效
		程序步[9].延时						
194	i32	program_block_step[10].Xtarget	0	-2147483647	2147483647	lu	直接修改	立即生效
		程序步[10].目标位置						
196	i32	program_block_step[10].Vtarget	1	1	2147483647	lu/s	直接修改	立即生效
		程序步[10].目标速度						
198	i32	program_block_step[10].delay	0	0	65535	ms	直接修改	立即生效
		程序步[10].延时						
200	i32	program_block_step[11].Xtarget	0	-2147483647	2147483647	lu	直接修改	立即生效
		程序步[11].目标位置						
202	i32	program_block_step[11].Vtarget	1	1	2147483647	lu/s	直接修改	立即生效
		程序步[11].目标速度						
204	i32	program_block_step[11].delay	0	0	65535	ms	直接修改	立即生效
		程序步[11].延时						
206	i32	program_block_step[12].Xtarget	0	-2147483647	2147483647	lu	直接修改	立即生效
		程序步[12].目标位置						

参数号 P	数据类型	名称	出厂值	最小值	最大值	单位	修改方式	生效方式
208	i32	program_block_step[12].Vtarget	1	1	2147483647	lu/s	直接修改	立即生效
	程序步[12].目标速度							
210	i32	program_block_step[12].delay	0	0	65535	ms	直接修改	立即生效
	程序步[12].延时							
212	i32	program_block_step[13].Xtarget	0	-2147483647	2147483647	lu	直接修改	立即生效
	程序步[13].目标位置							
214	i32	program_block_step[13].Vtarget	1	1	2147483647	lu/s	直接修改	立即生效
	程序步[13].目标速度							
216	i32	program_block_step[13].delay	0	0	65535	ms	直接修改	立即生效
	程序步[13].延时							
218	i32	program_block_step[14].Xtarget	0	-2147483647	2147483647	lu	直接修改	立即生效
	程序步[14].目标位置							
220	i32	program_block_step[14].Vtarget	1	1	2147483647	lu/s	直接修改	立即生效
	程序步[14].目标速度							
222	i32	program_block_step[14].delay	0	0	65535	ms	直接修改	立即生效
	程序步[14].延时							
224	i32	program_block_step[15].Xtarget	0	-2147483647	2147483647	lu	直接修改	立即生效
	程序步[15].目标位置							

参数号 P	数据类型	名称	出厂值	最小值	最大值	单位	修改方式	生效方式
226	i32	program_block_step[15].Vtarget	1	1	2147483647	lu/s	直接修改	立即生效
	程序步[15].目标速度							
228	i32	program_block_step[15].delay	0	0	65535	ms	直接修改	立即生效
	程序步[15].延时							
230	i32	program_block_step[16].Xtarget	0	-2147483647	2147483647	lu	直接修改	立即生效
	程序步[16].目标位置							
232	i32	program_block_step[16].Vtarget	1	1	2147483647	lu/s	直接修改	立即生效
	程序步[16].目标速度							
234	i32	program_block_step[16].delay	0	0	65535	ms	直接修改	立即生效
	程序步[16].延时							

11 常见问题

PLC 可以控制几个 MD 系列电机

PROFINET 版本：

S7-200 SMART：在不挂载其他 PROFINET 设备的情况下，最多可以控制 8 台。

S7-1200：在不挂载其他 PROFINET 设备的情况下，最多可以控制 16 台。

S7-1500：

CPU1511（V4.0 固件）在不挂载其他 PROFINET 设备的情况下，最多支持 128 台。

CPU1513（V4.0 固件）在不挂载其他 PROFINET 设备的情况下，最多支持 128 台。

CPU1515（V4.0 固件）在不挂载其他 PROFINET 设备的情况下，最多支持 256 台。

MODBUS-TCP 版本：

S7-200 SMART：在无其他开放式用户通信（OUC）应用的情况下，最多可以控制 8 台。

S7-1200：在无其他开放式用户通信（OUC）应用的情况下，最多可以控制 14 台。

S7-1500：

CPU1511（V4.0 固件）在无其他开放式用户通信（OUC）应用的情况下，最多可以控制 88 台。

CPU1513（V4.0 固件）在无其他开放式用户通信（OUC）应用的情况下，最多可以控制 88 台。

CPU1515（V4.0 固件）在无其他开放式用户通信（OUC）应用的情况下，最多可以控制 128 台。

无法连接设备

按照以下步骤排查：

- 1、检查设备的电源线缆是否正常，通过设备的状态指示灯，判断设备是否已上电。
- 2、检查设备的网络线缆是否正常，通过调试软件的搜索功能，判断设备的网络连通是否正常。

如何使能电机

在没有警告\报警\故障的情况下，通过切换运动模式即可使能电机。

无法使能轴

检查是否有故障未解决，在解决故障后给 ack_alarm（确认错误）一个至少保持 10ms 高电平的脉冲信号。。

启动任务后，轴不动

- 1、检查是否有报警或故障未解决，在解决故障后给 ack_alarm（确认错误）一个至少保持 10ms 高电平的脉冲信号。
- 2、检查信号 cancel_traversing 和 intermediate_stop 是否为 0，为 0 时轴不工作，应将其设置为 1。
- 3、motion_mode 运动模式切换与 execute 启动任务不要在同个 PLC 扫描周期进行，建议延迟 10ms 以上，再设置 execute 启动任务信号。
- 4、execute 启动任务信号的高电平保持时间太短，建议保持 10ms 以上。

扭矩回零时，未运行到行程末端就回零完成

- 1、检查参数【转矩限制】是否设置太小。
- 2、检查参数【扭矩回零阈值】是否设置太小。
- 3、检查机械结构运行阻力是否太大或者波动太大。

速度到达信号不稳定

- 1、检查参数【速度滤波指数】是否合适，当速度波动较大时可适当加大滤波指数。
- 2、检查参数【速度到达阈值】，当速度波动较大时，可以放宽阈值范围以确保速度到达信号有输出。
- 3、检查参数【速度到达驻留时间】。

轴静止信号不输出

- 1、检查参数【速度滤波指数】是否合适，当速度波动较大时可适当加大滤波指数。
- 2、检查参数【零速阈值】，当速度波动较大时，可以放宽阈值范围以确保轴静止信号有输出。
- 3、检查参数【零速驻留时间】。

如何设置细分

本产品并无“细分”这一概念。如果需要修改控制分辨率，可以参考章节[“设置机械结构”](#)。

电机只能往单侧方向移动

查看调试软件是否触发单侧限位警告，如【警告：到达正/负限位】（硬限位）或【警告：到达软正/负限位】（软限位）。

若为硬限位警告：检查限位开关是否被机械遮挡、接线松动或信号极性配置错误；

若为软限位警告：核对软正/负限位限制参数是否设置过小；

电机无法移动

- 1、检查电机是否使能。
- 2、检查“设定速度值”、“设定位置值”、“速度倍率”、“加速度倍率”是否合理。
- 3、检查调试软件上是否有“警告”、“报警”、“故障”信息

如果出现了“报警”或“故障”，电机将立即停止运行。此时应该先查看[“诊断”](#)章节，排查设备报警或故障的原因并解决后，通过调试软件的【确认错误】按钮或者通过实时报文中的【确认错误】标志位来解除报警或者故障标志位。

- 4、检查电机是否同时出现了【警告：到达正/负限位】(硬限位)，此时电机双向运动被强制锁定。

触发原因：(1)、启用了硬限位保护功能，且信号极性配置为常闭（NC），但实际未接线或接线错误，导致系统误判为限位触发。

(2)、测试时手动触发了正、负限位开关，并且在调试软件或 PLC 执行了【确认错误】后又触发了另一侧限位开关。导致“警告：到达正限位”、“警告：到达负限位”同时出现。

解除方法：临时关闭硬限位保护功能，此时两个方向的限位警告标志会被重置。限位状态清除后，请务必检查限位开关接线、信号极性 & 安装位置。确认无误后，务必重新启用硬限位保护以保障运行安全。